

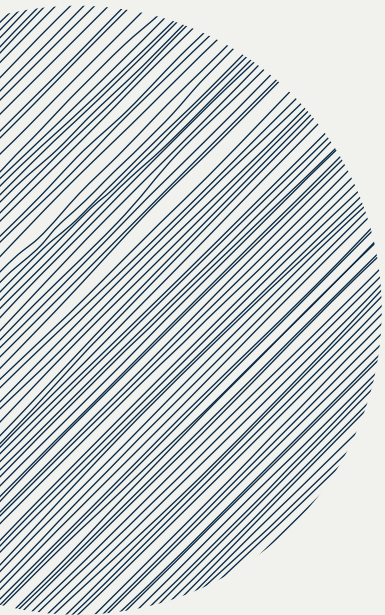

A VOTRE SERVICE DEPUIS 1995

AME **Z** EU S



Catalogue
LUMINAIRES
INTERIEURS ET EXTERIEURS

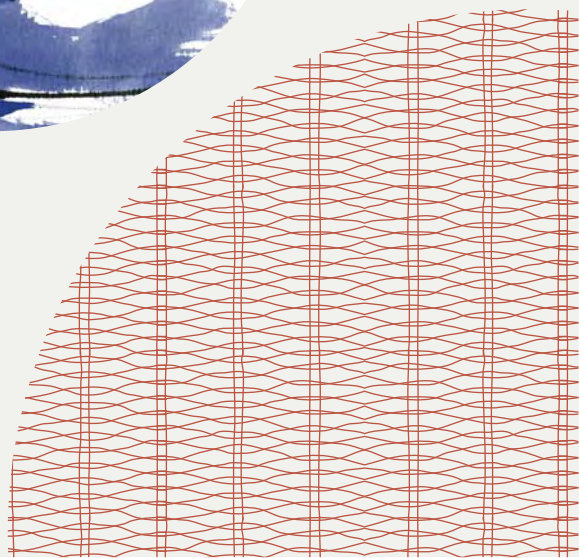

Taillepie 44, 1095 Lutry - www.amezeus.com
+41 21 903 57 67 - direction@amezeus.com

Atticus P/01 Battery
Atticus P/02



Atticus B/01



Atticus B/02



Atticus P/01 Battery



Atticus P/01 Battery



Atticus P/02

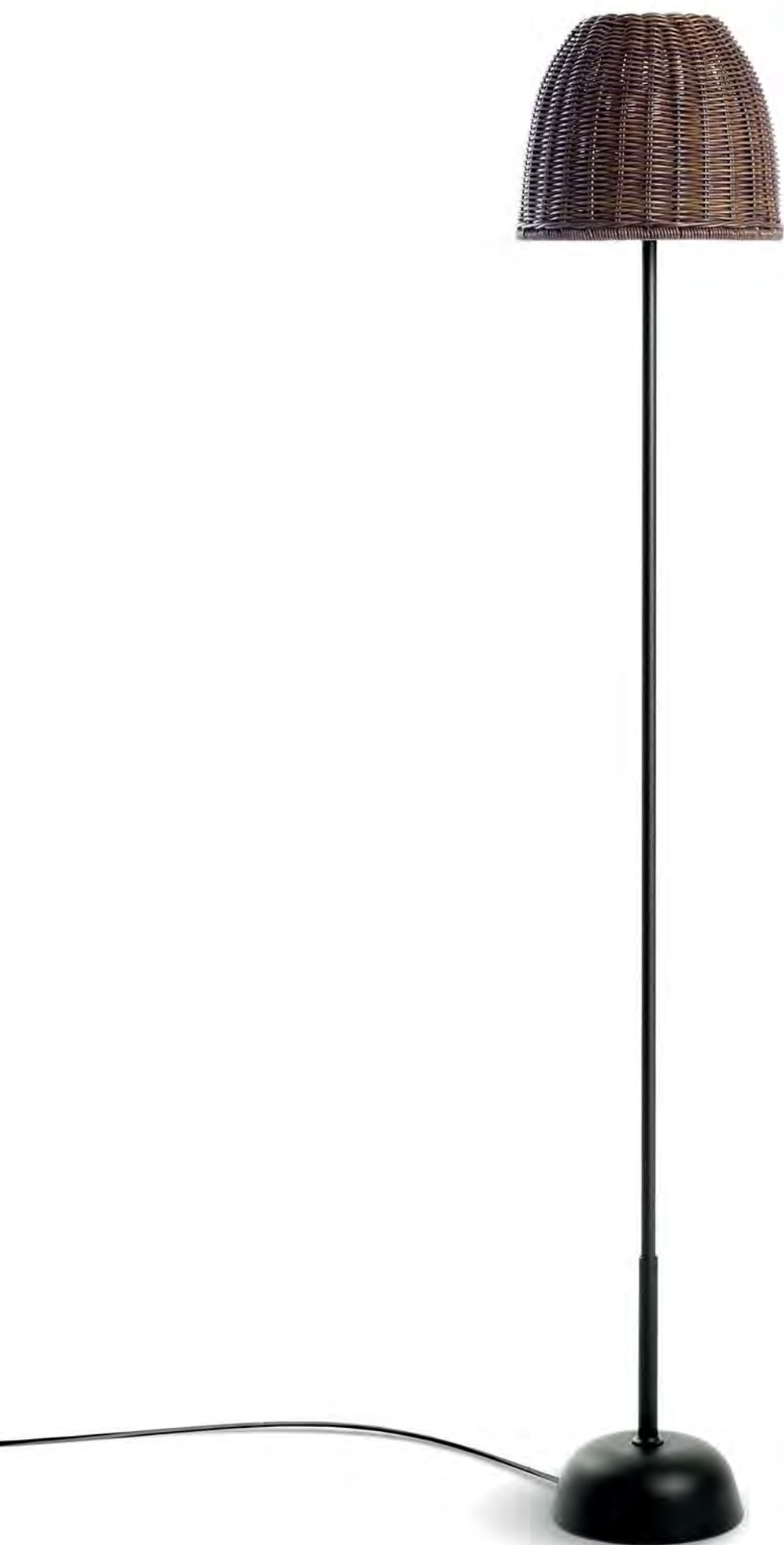

Atticus

Finishing

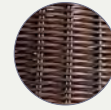

Brown



Ivory White

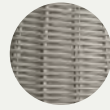

Light Beige

Atticus P/01 Battery

Pie exterior / Outdoor Floor

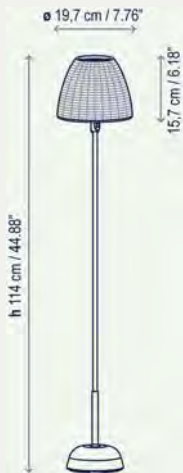

1 x 3,2 W LED | Lumens 400 lm
Valor cromático / CRI 90 | 2700K



Atticus P/02

Pie exterior / Outdoor Floor



1 x 9 W LED | Lumens 960 lm
Valor cromático / CRI 90 | 2700K



Atticus B/01- B/02

Baliza Exterior / Outdoor Bollard



Atticus B/01 Atticus B/02

1 x 9 W LED | Lumens 960 lm
Valor cromático / CRI 90 | 2700K



Cornet B/02



Cornet B/02





Cornet B/02



Cornet B/01



Cornet B/03



Cornet B/01 - B/02 - B/03



Cornet A/01



Cornet

Finishing

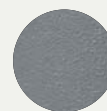

Stone Grey

Cornet A/01

Aplique Exterior / Outdoor Wall Lamp

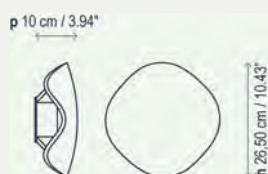

1 x 8 W LED | Lumens 860 lm
Valor cromático / CRI 90 | 2700K



Cornet B/01

Baliza Exterior / Outdoor Ballard



1 x 8 W LED | Lumens 860 lm
Valor cromático / CRI 90 | 2700K



Cornet B/02

Baliza Exterior / Outdoor Ballard



1 x 8 W LED | Lumens 860 lm
Valor cromático / CRI 90 | 2700K



Cornet B/03

Baliza Exterior / Outdoor Ballard

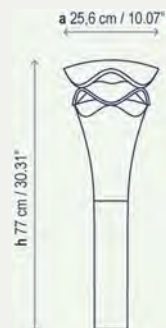

1 x 8 W LED | Lumens 860 lm
Valor cromático / CRI 90 | 2700K



Drop A/01



Drop A/03



Drop A/02



Drop S/01



Esta imagen de producto no muestra el florón estándar. *This product photography doesn't show the standard canopy.*

Drop S/06



Drop S/07



Drop S/24



Drop S/48

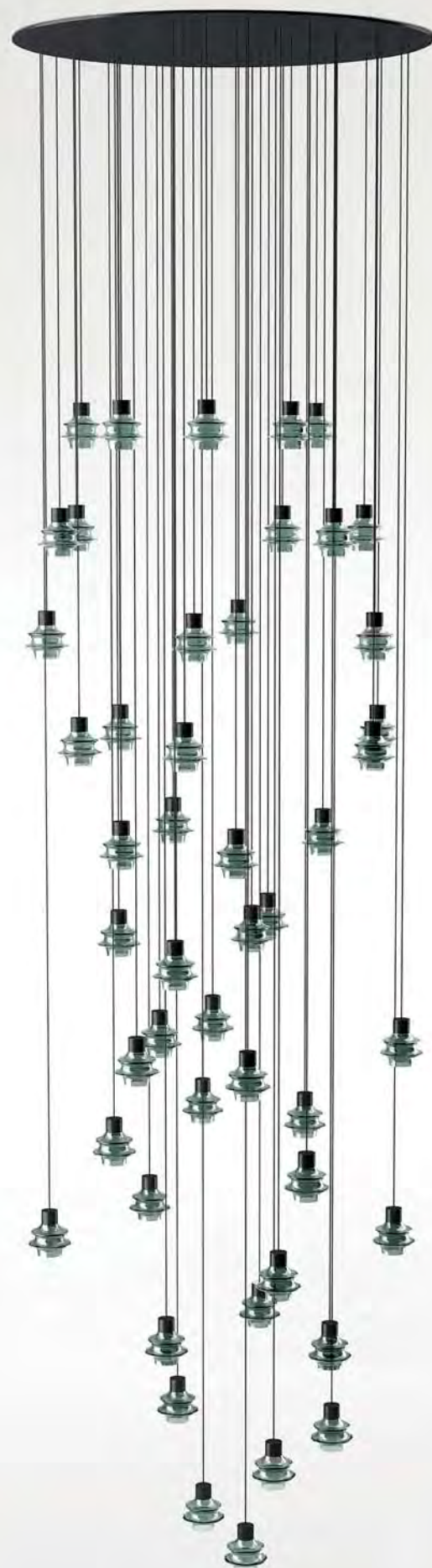

Drop Mini
Drop T/01



Drop Biblio



Drop P/01 Tray



Drop

Finishing



Drop A/01
Aplique / Wall Lamp

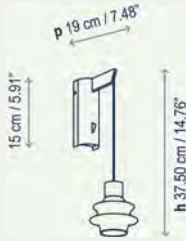

3 W LED | Lumens 345 lm
Valor cromático / CRI 90 | 2700K



Drop A/02
Aplique / Wall Lamp

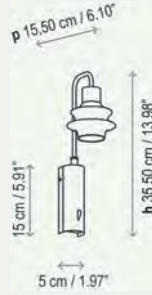

3 W LED | Lumens 345 lm
Valor cromático / CRI 90 | 2700K



Drop A/03
Aplique / Wall Lamp



3 W LED | Lumens 345 lm
Valor cromático / CRI 90 | 2700K



Drop S/01
Suspensión / Pendant Lamp

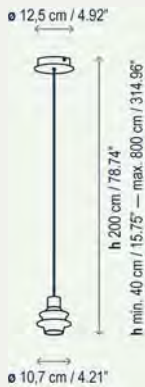

3 W LED | Lumens 345 lm
Valor cromático / CRI 90 | 2700K



Drop S/06
Suspensión / Pendant Lamp

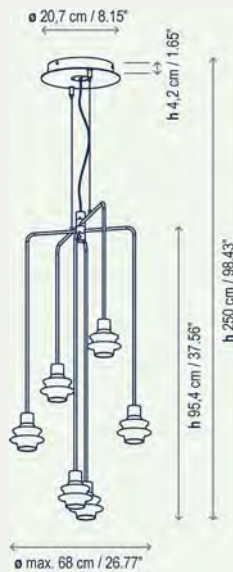

6 x 3 W = 18 W LED | Lumens 2070 lm
Valor cromático / CRI 90 | 2700K



Drop S/07
Suspensión / Pendant Lamp

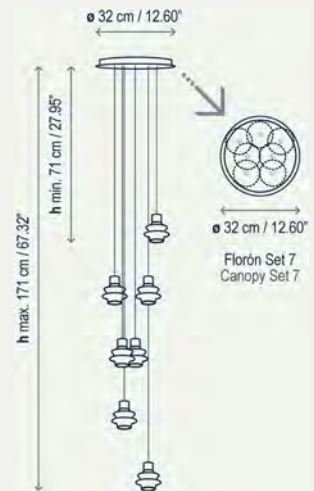

7 x 2.8 W = 19.6 W LED | Lumens 2604 lm
Valor cromático / CRI 90 | 2700K



Drop S/12
Suspensión / Pendant Lamp

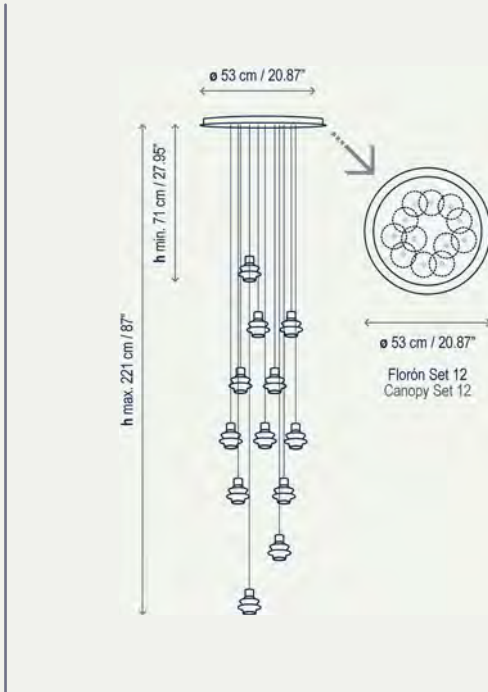

12 x 2,8 W = 33,6 W LED | Lumens 4464 lm
Valor cromático / CRI 90 | 2700K



Drop S/24
Suspensión / Pendant Lamp

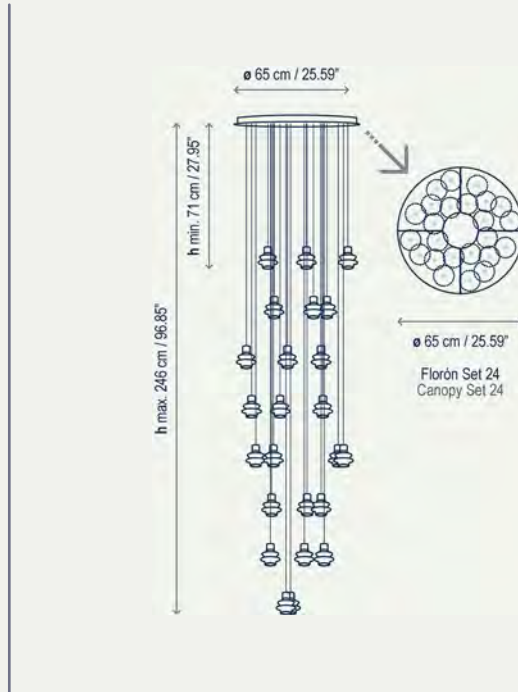

24 x 2,8 W = 67,2 W LED | Lumens 8928 lm
Valor cromático / CRI 90 | 2700K



Drop S/36
Suspensión / Pendant Lamp

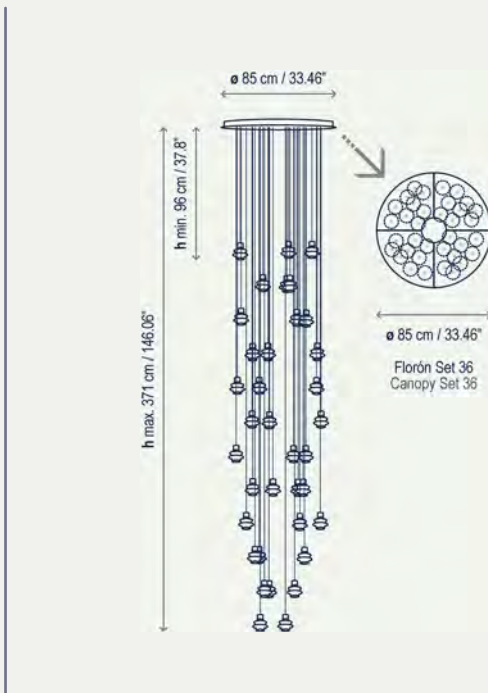

36 x 2,8 W = 100,8 W LED | Lumens 15392 lm
Valor cromático / CRI 90 | 2700K



Drop S/48
Suspensión / Pendant Lamp

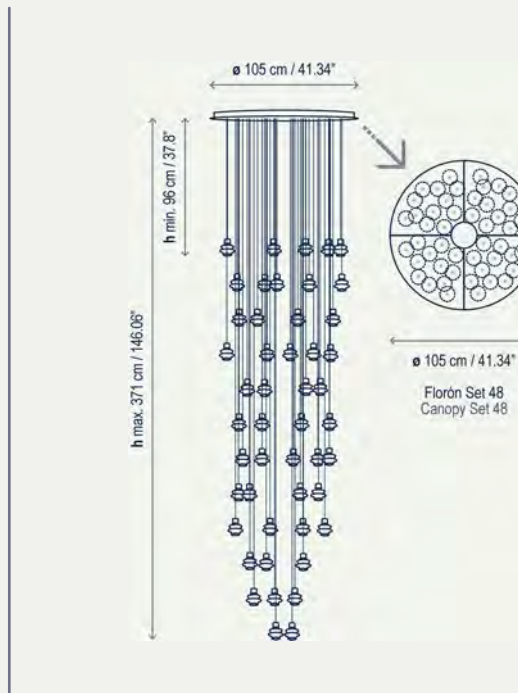

48 x 2,8 W = 134,4 W LED | Lumens 17856 lm
Valor cromático / CRI 90 | 2700K



Drop Mini
Mesa / Table Lamp



Interruptor en el cable / Through cord switch



Interruptor Proxy Dimmer / Proxy Dimmer Switch

3 W LED | Lumens 345 lm
Valor cromático / CRI 90 | 2700K



Drop T/01
Mesa / Table Lamp



Interruptor en el cable / Through cord switch



Interruptor Proxy Dimmer / Proxy Dimmer Switch

3 W LED | Lumens 345 lm
Valor cromático / CRI 90 | 2700K



Drop Biblio
Mesa / Table Lamp

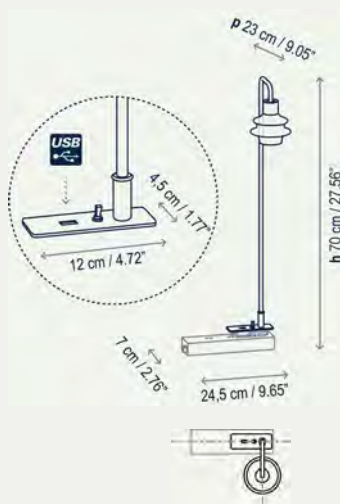

3 W LED | Lumens 345 lm
Valor cromático / CRI 90 | 2700K



Drop P/01 Tray
Pie / Floor Lamp

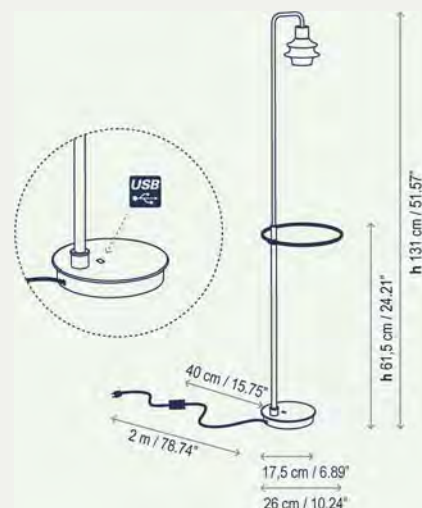

3 W LED | Lumens 345 lm
Valor cromático / CRI 90 | 2700K



Drip A/01



Drip S/01



Drip Mini



Drip P/01 Tray



Drip

Finishing



Drip A/01
Aplique / Wall Lamp

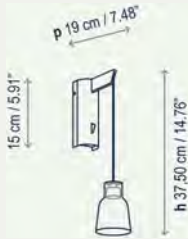

3 W LED | Lumens 345 lm
Valor cromático / CRI 90 | 2700K



Drip A/02
Aplique / Wall Lamp

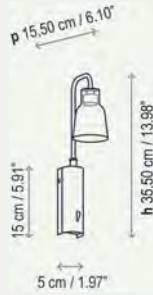

3 W LED | Lumens 345 lm
Valor cromático / CRI 90 | 2700K



Drip A/03
Aplique / Wall Lamp



3 W LED | Lumens 345 lm
Valor cromático / CRI 90 | 2700K



Drip S/01
Suspensión / Pendant Lamp

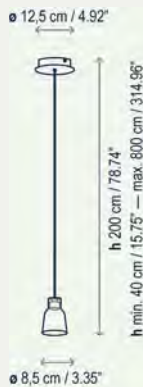

3 W LED | Lumens 345 lm
Valor cromático / CRI 90 | 2700K



Drip S/06
Suspensión / Pendant Lamp

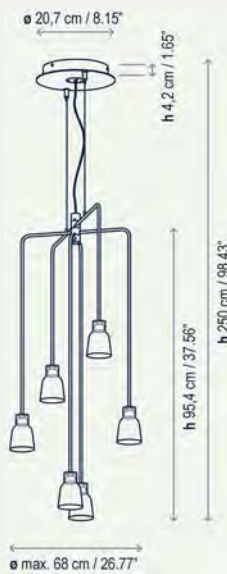

6 x 3 W = 18 W LED | Lumens 2070 lm
Valor cromático / CRI 90 | 2700K



Drip S/07
Suspensión / Pendant Lamp

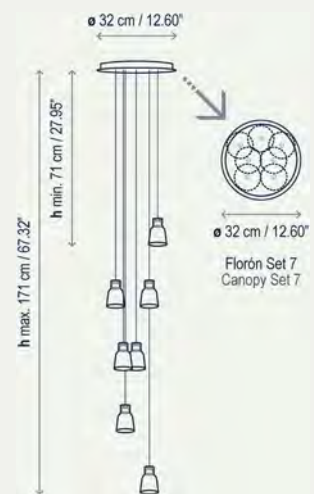

7 x 2.8 W = 19.6 W LED | Lumens 2604 lm
Valor cromático / CRI 90 | 2700K



Drip S/12
Suspensión / Pendant Lamp

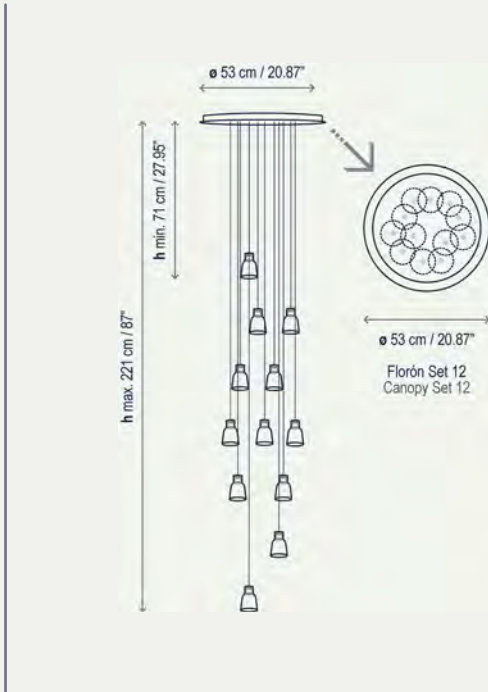

12 x 2,8 W = 33,6 W LED | Lumens 4464 lm
Valor cromático / CRI 90 | 2700K



Drip S/24
Suspensión / Pendant Lamp

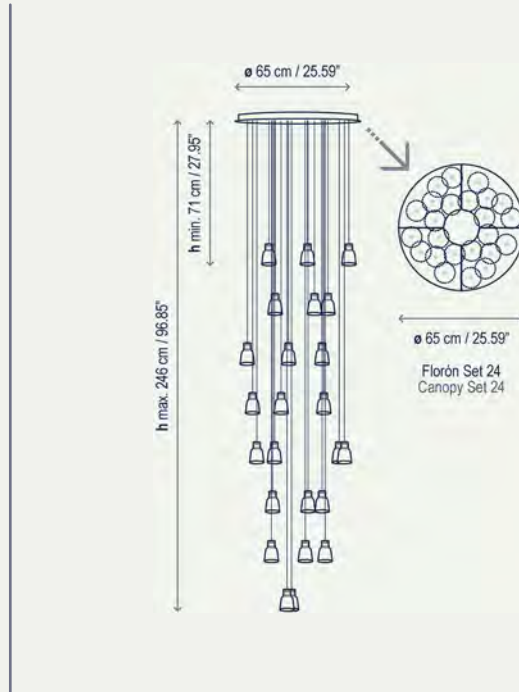

24 x 2,8 W = 67,2 W LED | Lumens 8928 lm
Valor cromático / CRI 90 | 2700K



Drip S/36
Suspensión / Pendant Lamp

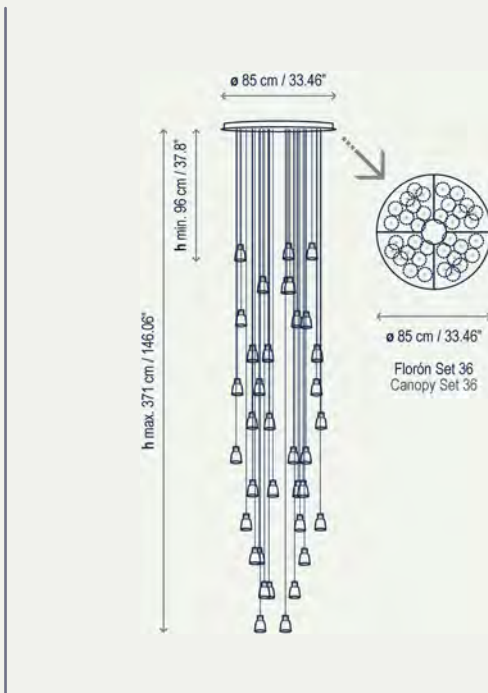

36 x 2,8 W = 100,8 W LED | Lumens 13392 lm
Valor cromático / CRI 90 | 2700K



Drip S/48
Suspensión / Pendant Lamp

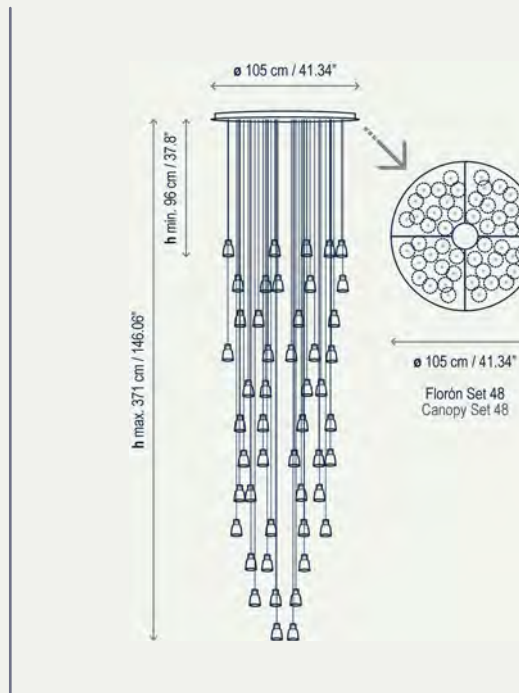

48 x 2,8 W = 134,4 W LED | Lumens 17856 lm
Valor cromático / CRI 90 | 2700K



Drip Mini
Mesa / Table Lamp



Interruptor en el cable / Through cord switch

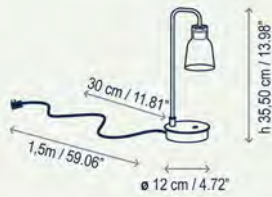

Interruptor Proxy Dimmer / Proxy Dimmer Switch

3 W LED | Lumens 345 lm
Valor cromático / CRI 90 | 2700K



Drip T/01
Mesa / Table Lamp



Interruptor en el cable / Through cord switch



Interruptor Proxy Dimmer / Proxy Dimmer Switch

3 W LED | Lumens 345 lm
Valor cromático / CRI 90 | 2700K



Drip Biblio
Mesa / Table Lamp

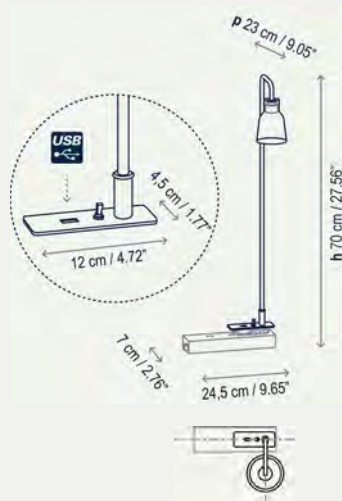

3 W LED | Lumens 345 lm
Valor cromático / CRI 90 | 2700K



Drip P/01 Tray
Pie / Floor Lamp

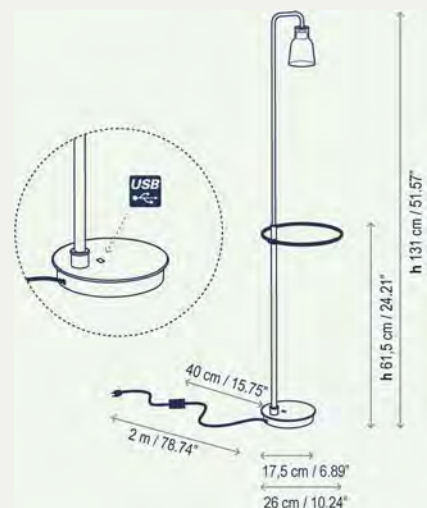

3 W LED | Lumens 345 lm
Valor cromático / CRI 90 | 2700K



Marietta Outdoor





Marietta Outdoor





Marietta Outdoor

Marietta Outdoor
Suspensión Exterior / Outdoor Pendant Lamp



1 x 8 W LED | Lumens 664 lm
Valor cromático / CRI 80 | 2700K



Moai B /01



Moai B/02





Moai B/01 - B/02



Moai

Finishing

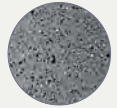

Grey
Concrete

Moai B/01

Baliza Exterior / Outdoor Bollard



1 x 6,5 W LED | Lumens 850 lm
Valor cromático / CRI 90 | 2700K



Moai B/02

Baliza Exterior / Outdoor Bollard

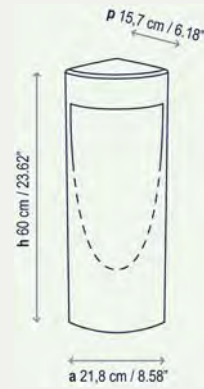

1 x 6,5 W LED | Lumens 850 lm
Valor cromático / CRI 90 | 2700K



Penta S



Penta S



Penta S



Penta S



Penta S

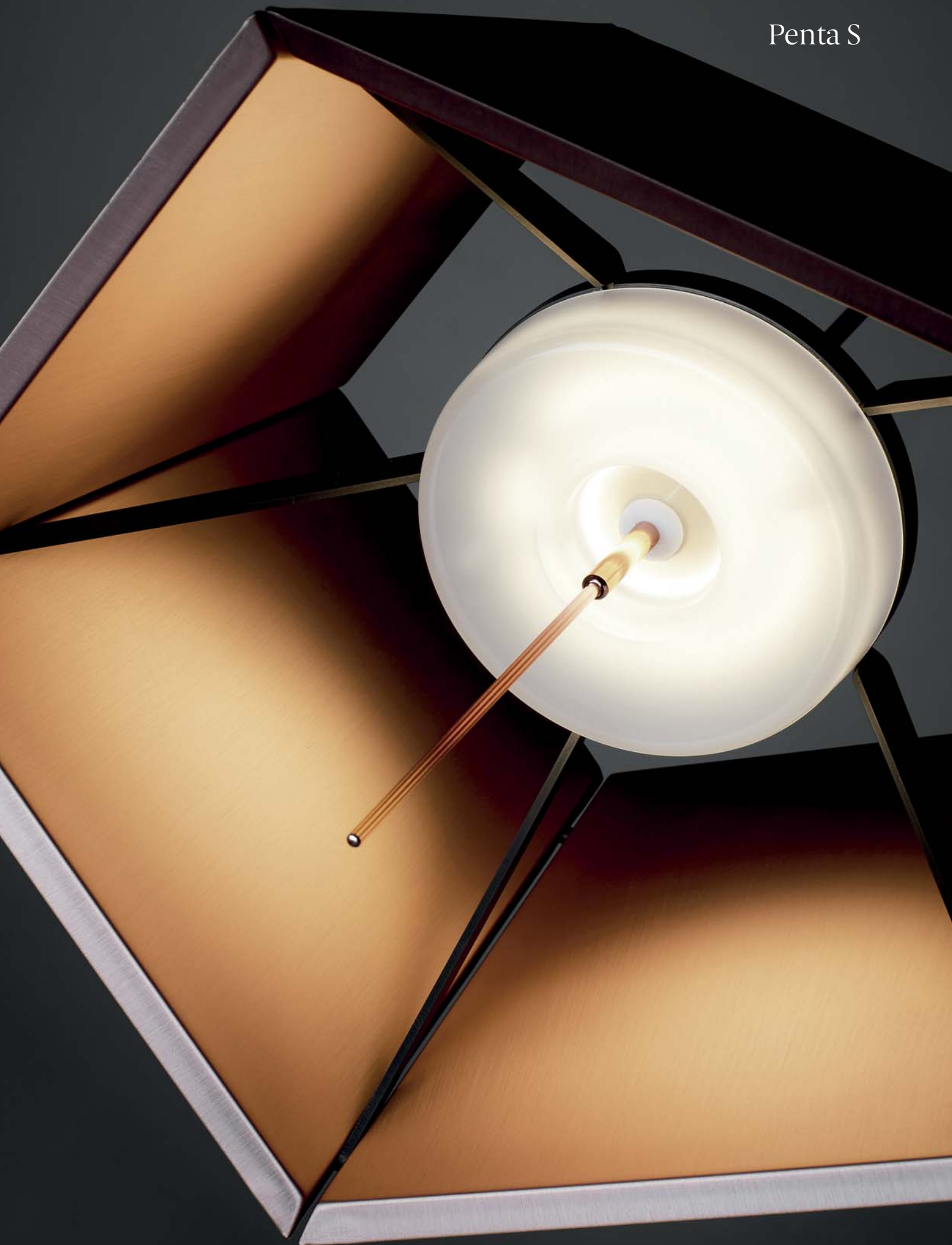



Penta T



Penta P



Penta

Finishing



Penta S
Suspensión / Pendant Lamp



8,2 W LED | Lumens 799 lm
Valor cromático / CRI 90 | 2700K



Penta T
Mesa / Table Lamp



8,2 W LED | Lumens 799 lm
Valor cromático / CRI 90 | 2700K



Penta P
Pie / Floor Lamp

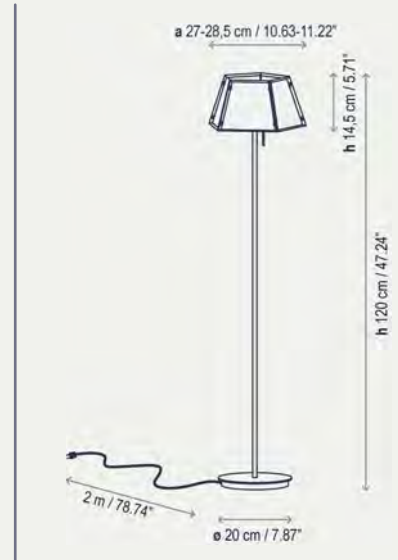

8,2 W LED | Lumens 799 lm
Valor cromático / CRI 90 | 2700K



Tibeta



Tibeta 01



Tibeta

Finishing



Black
Chrome

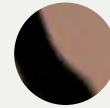

Brilliant
copper



Antique
brass

Tibeta 01

Suspensión / Pendant Lamp

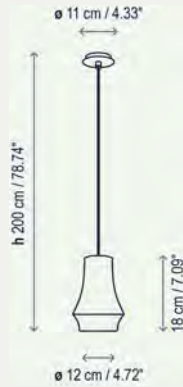

8,7 W LED | Lumens 610 lm
Valor cromático / CRI >80 | 2900-3200K



Tibeta 02

Suspensión / Pendant Lamp

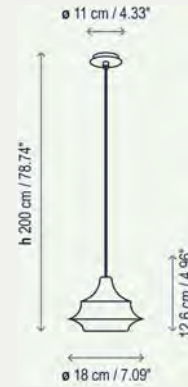

8,7 W LED | Lumens 610 lm
Valor cromático / CRI >80 | 2900-3200K



Tibeta 03

Suspensión / Pendant Lamp

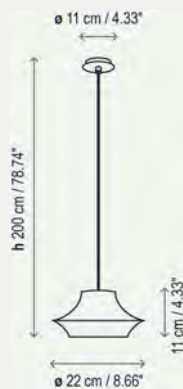

13 W LED | Lumens 935 lm
Valor cromático / CRI >80 | 2900-3200K



Tibeta Set 3

Suspensión / Pendant Lamp

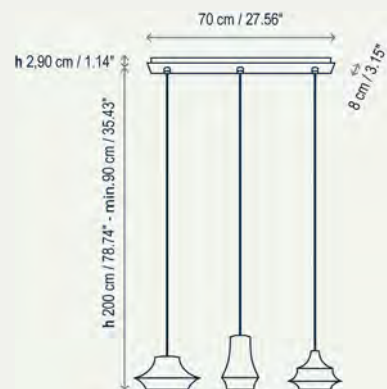

30,4 W LED | Lumens 2155 lm
Valor cromático / CRI >80 | 2900-3200K



CATALOGUE GENERAL LUMINAIRES

Extérieurs, murals, suspendus et plafonniers

EXTERIOR
OUTDOOR

PAG 11



AMPHORA, 12
FORA, 18
MAXI, 32
LINEANA, 36

APLIQUES
WALL LAMP

PAG 41



BASIK, 42
BCN, 44
CARLOTA, 48
CARLOTA FL, 50
CLUB, 52
FLEXO, 54
FLEXO LEXA, 56
KLAR, 58
KLEINE, 60
LEA, 62
LEXA, 66
LEXA FL, 70
LIBAN, 72
MEI OVAL, 74
PLANA, 78
SILANTRA, 84
SPOCK, 90
TIMEA, 92
TWALL, 94
WALL STREET, 96
WALL STREET FL, 98
WALL STREET T5, 100

SUSPENSIÓN
PENDANT LAMP

PAG 103



CALA, 104
CLUB, 108
DANONA, 110
ELEA, 113
ELIPSE, 118
GLO, 122
HARDY, 126
INARI, 130
LÁMPARA XVIII, 134
LUA, 138
MAR, 140
MAXI, 142
MEI, 146
MEI OVAL, 156
MOS, 158
OLIVER, 164
ROLANDA, 168
SIAM, 172
SILANTRA, 176
TAU, 180
TEKNO, 182
TWINS, 186
URBAN, 190

PLAFÓN
CEILING LAMP

PAG 195



CALA, 196
ELEA, 200
KUADRAT, 204
OLIVER, 206
PLAFONET, 210
RONDO, 214
SIAM, 216
URBAN, 220

MESA
TABLE LAMP
PAG 225



CARLOTA, 226
CLUB, 228
DANONA, 230
EMA, 232
GIBSI, 234
INARI, 236
MANI, 238
MEI OVAL, 240
MUF, 242
ONNE, 246
ROLANDA, 250
SPOCK, 252
TAU, 256
TAU MADERA, 258
ULMA, 260

PIE
FLOOR LAMP
PAG 263



CARLOTA, 264
CLUB, 266
DANONA, 268
EMA, 270
INARI, 272
MAXI, 274
MEI OVAL, 276
ROLANDA, 278
SPOCK, 280
TAU, 282
TAU MADERA, 284
TIMEA, 286
ULMA, 288

ARTESANAL
HAND-CRAFTING
PAG 291



AVANI, 292
FERRARA, 294
TOUS, 305

MESAS AUXILIARES
TABLES
PAG 309



PEANA, 310
BANE, 314

CHRISTOPHE MATHIEU



LUIS VIÑAS



JOANA BOVER



CARLES RIART



LLUÍS PORQUERAS

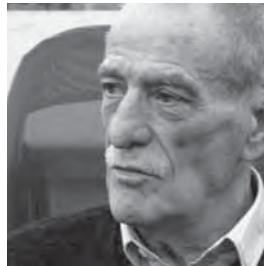

ALEX FERNÁNDEZ CAMPS



GONZALO MILÀ



JORDI LLOPIS



SERGI & ÒSCAR DEVESA



A close-up photograph of a dark brown, textured material, likely a chair or table, with a white background. The texture is a fine, repeating pattern of small, dark, rectangular shapes. The material is curved, and the lighting creates a slight shadow on the left side.

EXTERIOR
OUTDOOR

AMPHORA - 01

PIE EXTERIOR
OUTDOOR FLOOR



2 x 22 W E-27

ø 49 cm / 19.29"

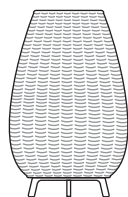

h 77.50 cm / 30.51"

0133003 MARRÓN / BROWN GRAPHITE

Pantalla 49 x 69,5 cm / Lampshade 19.29" x 27.36"
Fibra Sintética / Synthetic Fiber

P-741 BEIGE CLARO / LIGHT BEIGE

P-742 MARRÓN / BROWN

AMPHORA - 02

PIE EXTERIOR
OUTDOOR FLOOR



2 x 30 W E-27

ø 80 cm / 31.50"

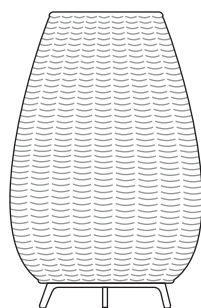

h 123 cm / 48.43"

0233003 MARRÓN / BROWN GRAPHITE

Pantalla 80 x 113,5 cm / Lampshade 31.50" x 44.69"
Fibra Sintética / Synthetic Fiber

P-744 BEIGE CLARO / LIGHT BEIGE

P-745 MARRÓN / BROWN

AMPHORA - 03

PIE EXTERIOR
OUTDOOR FLOOR



2 x 30 W E-27

ø 89 cm / 35.04"

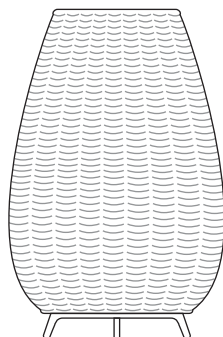

h 137 cm / 53.94"

0333003 MARRÓN / BROWN GRAPHITE

Pantalla 89 x 127 cm / Lampshade 35.04" x 50"
Fibra Sintética / Synthetic Fiber

P-747 BEIGE CLARO / LIGHT BEIGE

P-748 MARRÓN / BROWN



Acabados especiales bajo pedido:
MARRÓN CHOCOLATE, BLANCO o MOSTAZA.
Plazo de entrega: 3 meses.
Special finishings upon request:
BROWN CHOCOLATE, WHITE, MUSTARD.
Delay: 3 months.

ACABADOS / FINISHING

MARRÓN BROWN GRAPHITE BEIGE CLARO LIGHT BEIGE MARRÓN BROWN

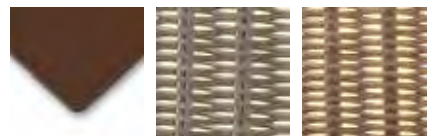











FORA

SUSPENSIÓN EXTERIOR
OUTDOOR PENDANT LAMP

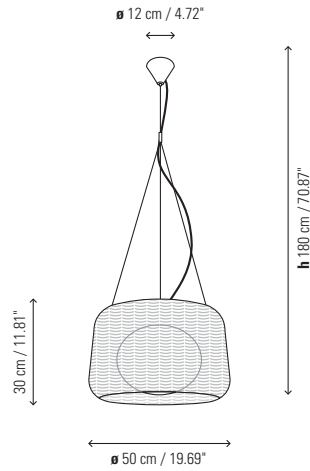
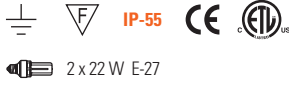

- 4130301 BLANCO ROTO / NATURAL WHITE
- 4130303 MARRÓN / BROWN GRAPHITE
- 4130308 GRIS GRAFITO / GREY GRAPHITE

Fibra Sintética Polietileno / Synthetic Polyethylene Fiber

- P-694 C GRIS GRAFITO / GREY GRAPHITE
- P-695 C BEIGE CLARO / LIGHT BEIGE
- P-696 C MARRÓN / BROWN

La fuente de luz está protegida por un globo de polietileno de media densidad y protección UV.
Light source is protected by polyethylene globe of medium density and UV protection.

Fotometría disponible / Photometry available

FORA - 90

SUSPENSIÓN EXTERIOR
OUTDOOR PENDANT LAMP

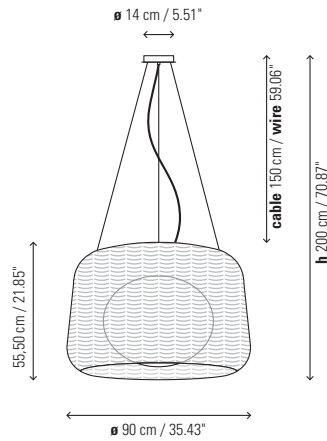

- 4030301 BLANCO ROTO / NATURAL WHITE
- 4030303 MARRÓN / BROWN GRAPHITE
- 4030308 GRIS GRAFITO / GREY GRAPHITE

Fibra Sintética Polietileno / Synthetic Polyethylene Fiber

- P-706 C GRIS GRAFITO / GREY GRAPHITE
- P-707 C BEIGE CLARO / LIGHT BEIGE
- P-708 C MARRÓN / BROWN

La fuente de luz está protegida por un globo de polietileno de media densidad y protección UV.
Light source is protected by polyethylene globe of medium density and UV protection.

Fotometría disponible / Photometry available

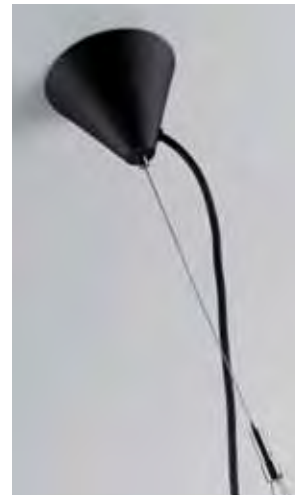

FAMÍLIA / FAMILY

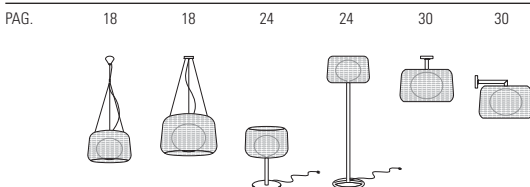

ACABADOS / FINISHING













FORA - MESA

LÁMPARA EXTERIOR
OUTDOOR LAMP

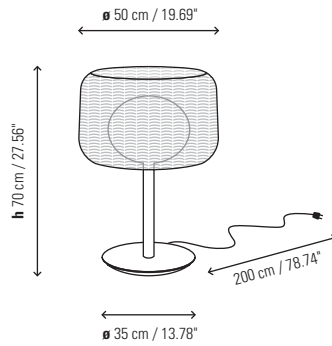

- 2230301 BLANCO ROTO / NATURAL WHITE
- 2230303 MARRÓN / BROWN GRAPHITE
- 2230308 GRIS GRAFITO / GREY GRAPHITE

Fibra Sintética Polietileno / Synthetic Polyethylene Fiber

- P-694 GRIS GRAFITO / GREY GRAPHITE
- P-695 BEIGE CLARO / LIGHT BEIGE
- P-696 MARRÓN / BROWN

La fuente de luz está protegida por un globo de polietileno de media densidad y protección UV. / Light source is protected by polyethylene globe of medium density and UV protection.

Fotometría disponible / Photometry available

FORA - PIE

LÁMPARA EXTERIOR
OUTDOOR LAMP

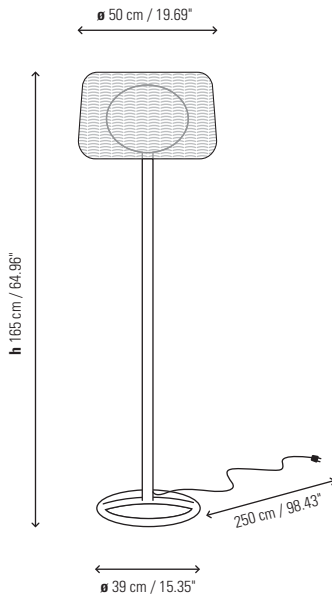

- 3030301 BLANCO ROTO / NATURAL WHITE
- 3030303 MARRÓN / BROWN GRAPHITE
- 3030308 GRIS GRAFITO / GREY GRAPHITE

Fibra Sintética Polietileno / Synthetic Polyethylene Fiber

- P-694 GRIS GRAFITO / GREY GRAPHITE
- P-695 BEIGE CLARO / LIGHT BEIGE
- P-696 MARRÓN / BROWN

La fuente de luz está protegida por un globo de polietileno de media densidad y protección UV. / Light source is protected by polyethylene globe of medium density and UV protection.

La base de fundición de hierro destaca por su forma radial que facilita el paso de la luz sobre el césped, evitando su deterioro. / The cast iron base is distinguished by a radial base whose tubular design improves durability and allows light to reach the grass.

Consulte las opciones de anclaje al suelo. / Consult floor fastening options.

Fotometría disponible / Photometry available



FAMILIA / FAMILY

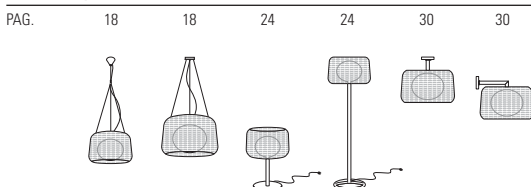

ACABADOS / FINISHING







Hotel Nord 1901 / Girona







FORA - APLIQUE

APLIQUE EXTERIOR
OUTDOOR WALL LIGHT

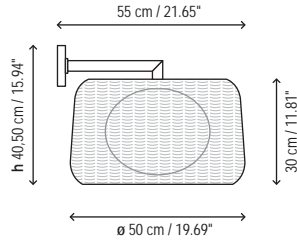

- 1130301 BLANCO ROTO / *NATURAL WHITE*
- 1130303 MARRÓN / *BROWN GRAPHITE*
- 1130308 GRIS GRAFITO / *GREY GRAPHITE*

Fibra Sintética Polietileno / *Synthetic Polyethylene Fiber*

- P-694 C GRIS GRAFITO / *GREY GRAPHITE*
- P-695 C BEIGE CLARO / *LIGHT BEIGE*
- P-696 C MARRÓN / *BROWN*

Fotometría disponible / *Photometry available*

FORA - PLAFÓN

PLAFÓN EXTERIOR
OUTDOOR CEILING

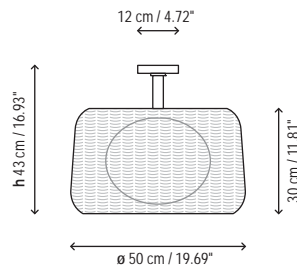

- 5130301 BLANCO ROTO / *NATURAL WHITE*
- 5130303 MARRÓN / *BROWN GRAPHITE*
- 5130308 GRIS GRAFITO / *GREY GRAPHITE*

Fibra Sintética Polietileno / *Synthetic Polyethylene Fiber*

- P-694 C GRIS GRAFITO / *GREY GRAPHITE*
- P-695 C BEIGE CLARO / *LIGHT BEIGE*
- P-696 C MARRÓN / *BROWN*

Fotometría disponible / *Photometry available*

FAMÍLIA / *FAMILY*

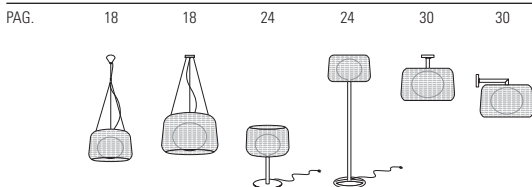

ACABADOS / *FINISHING*





MAXI - P

LÁMPARA EXTERIOR
OUTDOOR LAMP



2 x 28 W T5 HE

2 x 54 W T5 HO

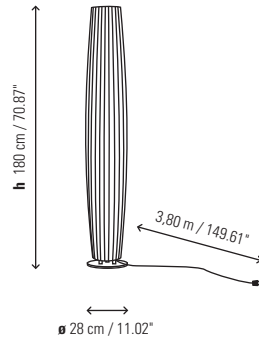

3229500 BLANCO / WHITE

Inclusión de tubos fluorescentes (2x28W) ya instalados en el interior de la luminaria.
Supply fluorescent tubes (2x28W) already installed inside the luminaire.

La fuente de luz esta protegida por una pantalla de Fibra de Polietileno
Light source is protected by a Polyethylene Fiber shade

Apta para fijación al suelo
Suitable for floor mounting

Fotometría disponible / *Photometry available*

MAXI - S

SUSPENSIÓN EXTERIOR
OUTDOOR PENDANT LAMP



2 x 28 W T5 HE

2 x 54 W T5 HO

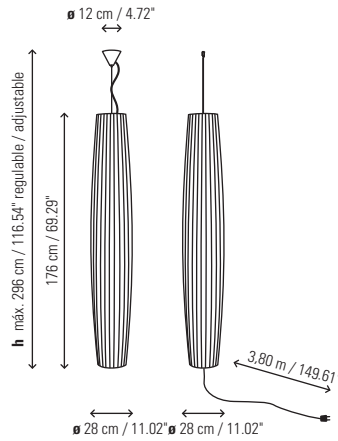

4429500TOP INSTALACIÓN SUPERIOR / *ELECTRICAL UPPER INSTALLATION*
4429500INF INSTALACIÓN INFERIOR / *ELECTRICAL BOTTOM INSTALLATION*

Inclusión de tubos fluorescentes (2x28W) ya instalados en el interior de la luminaria.
Supply fluorescent tubes (2x28W) already installed inside the luminaire.

La fuente de luz esta protegida por una pantalla de Polietileno
Light source is protected by a Polyethylene shade
Altura regulable cable tensor con seguro / *Adjustable tensor wire*
Floron acabado blanco / *White canopy finished*
(Solo para instalacion superior/ *only for Upper installation*)

Tubo rígido consultar / opcional
Rigid stem available upon request

Fotometría disponible / *Photometry available*

FAMILIA / FAMILY

PAG. 32 32 32 142 142 142 274 274



EXTERIOR / OUTDOOR



INTERIOR / INDOOR

ACABADOS / FINISHING

BLANCO
WHITE





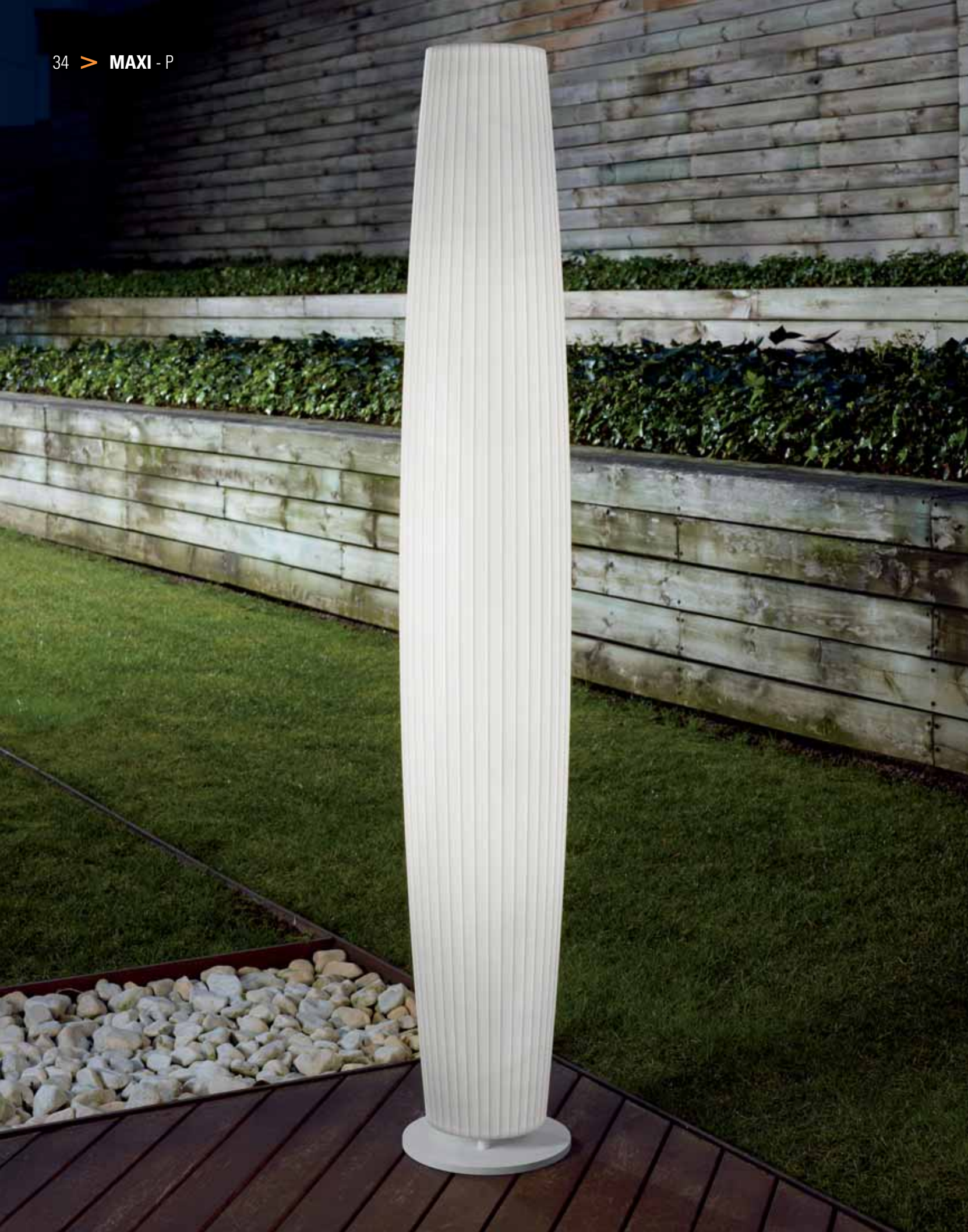



LINEANA - H

APLIQUE EXTERIOR
OUTDOOR WALL LIGHT



2 x 9 W G9 Bajo consumo

Led: 26 W
Lumens: 1.880 lm
Grados Kelvin 3.000°
Degrees Kelvin: 3.000°
Valor cromático / CRI: 80

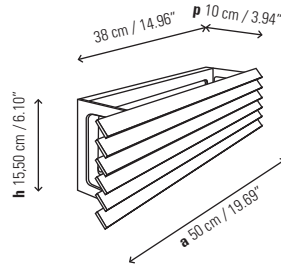

1121208 H GRIS GRAFITO (G9) / GRAPHITE GREY (G9)
1121203 H MARRÓN GRAFITO (G9) / BROWN GRAPHITE (G9)

1121208 LH GRIS GRAFITO (LED) / GRAPHITE GREY (LED)
1121203 LH MARRÓN GRAFITO (LED) / BROWN GRAPHITE (LED)

Caja soporte: 38 x 15 cm / Surface back box: 14.96" x 5.91"

Fotometría disponible G9 / Photometry available G9

LINEANA - V

APLIQUE EXTERIOR
OUTDOOR WALL LIGHT



2 x 9 W G9 Bajo consumo

Led: 26 W
Lumens: 1.880 lm
Grados Kelvin 3.000°
Degrees Kelvin: 3.000°
Valor cromático / CRI: 80

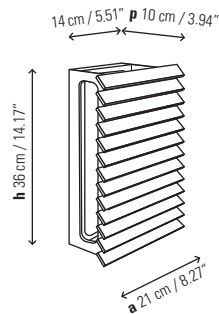

1121208 V GRIS GRAFITO (G9) / GRAPHITE GREY (G9)
1121203 V MARRÓN GRAFITO (G9) / BROWN GRAPHITE (G9)

1121208 LV GRIS GRAFITO (LED) / GRAPHITE GREY (LED)
1121203 LV MARRÓN GRAFITO (LED) / BROWN GRAPHITE (LED)

Caja soporte 14 x 31 cm / Surface back box: 5.51" x 12.20"

Fotometría disponible G9 / Photometry available G9

LINEANA - IPÉ

APLIQUE EXTERIOR 2011
OUTDOOR WALL LIGHT 2011



2 x 9 W G9 Bajo consumo

Led: 26 W
Lumens: 1.880 lm
Grados Kelvin 3.000°
Degrees Kelvin: 3.000°
Valor cromático / CRI: 80

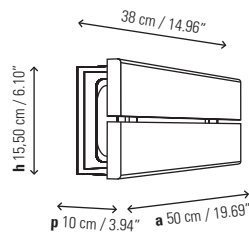

IPE21208 H GRIS GRAFITO (G9) / GRAPHITE GREY (G9)
IPE21203 H MARRÓN GRAFITO (G9) / BROWN GRAPHITE (G9)

IPE21208 LH GRIS GRAFITO (LED) / GRAPHITE GREY (LED)
IPE21203 LH MARRÓN GRAFITO (LED) / BROWN GRAPHITE (LED)

Fotometría disponible / Photometry available

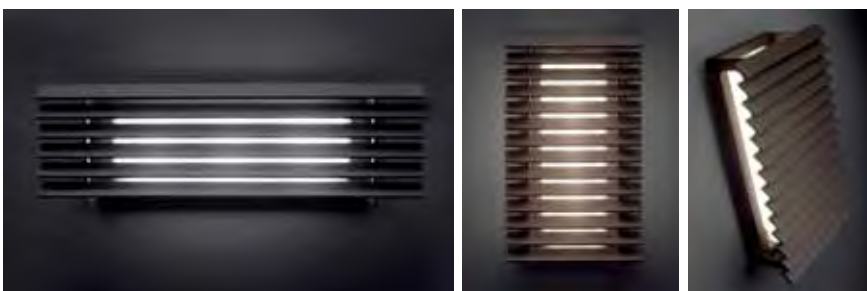

ACABADOS / FINISHING

MARRÓN / BROWN GRAPHITE GRIS GRAFITO / GREY GRAPHITE IPÉ / IPE





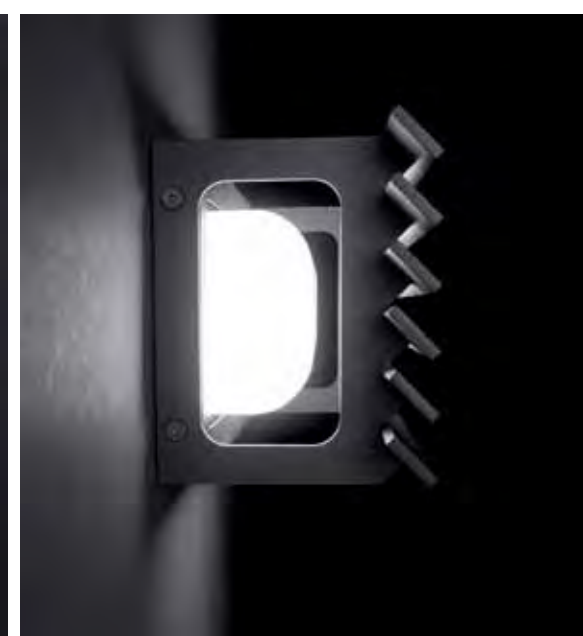





APLIQUES *WALL LAMP*



BASIK - 02

APLIQUE
WALL LAMP



1 x 42 W Classic P ECO E-27

1 x 11 W E-27

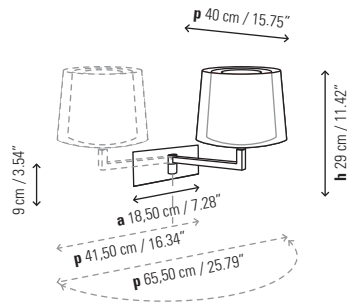

- 1132105 NÍQUEL SATINADO / SATIN NICKEL
- 1132106 CROMO BRILLANTE / BRILLIANT CHROME

Pantalla Exterior: 22 x 16 x 18 cm / Outer lampshade 8.66" x 6.30" x 7.09"
 P-633E COTONET BLANCO / WHITE COTTON
 Pantalla algodón sin tapa superior / Cotton shade without upper diffuser

- P-634E CINTA TRANSLÚCIDA BLANCA / WHITE TRANSLUCENT RIBBON
- P-635E CINTA TRANSLÚCIDA CREMA / CREAM TRANSLUCENT RIBBON

- P-636E NEGRO / BLACK MESH
 - P-637E ROJO / RED MESH
- Exterior pantalla de PVC cristal / Outer lampshade: PVC cristal

Pantalla Interior / Inner lampshade
 P-636I NEGRO / BLACK MESH
 P-637I ROJO / RED MESH
 Interior pantalla film poliéster rígido resistente al calor
 Inner shade made of a fireresistent polyester rigid film

Brazo móvil / Swivel arm
 Caja soporte: 17x 9 cm / Surface back box: 6.69" x 3.54"

ACABADOS / FINISHING

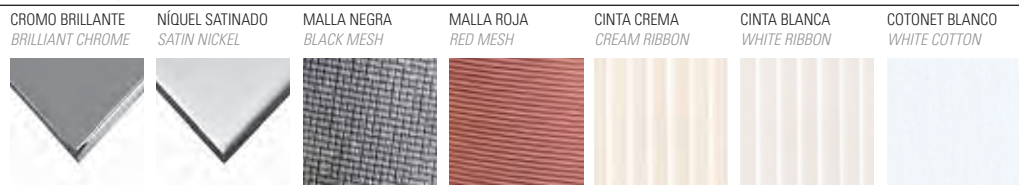



BCN

APLIQUE
WALL LAMP



2 x 24 W T5 Fluorescente
Reactancia electrónica

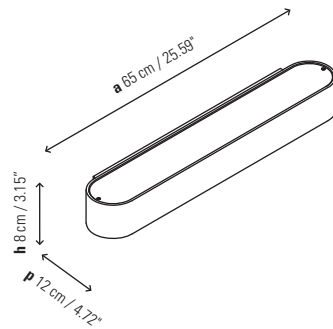

- 1526501 REACTANCIA ELECTRÓNICA / BLANCO LACADO BRILLANTE
ELECTRONIC BALLAST / WHITE BRILLIANT LACQUER
- 1526523 REACTANCIA ELECTRÓNICA / NEGRO LACADO BRILLANTE
ELECTRONIC BALLAST / BLACK BRILLIANT LACQUER
- 1526522 REACTANCIA ELECTRÓNICA / ROJO LACADO BRILLANTE
ELECTRONIC BALLAST / RED BRILLIANT LACQUER
- D1526501 REACTANCIA DIMABLE / BLANCO LACADO BRILLANTE
DIMMING BALLAST / WHITE BRILLIANT LACQUER
- D1526523 REACTANCIA DIMABLE / NEGRO LACADO BRILLANTE
DIMMING BALLAST / BLACK BRILLIANT LACQUER
- D1526522 REACTANCIA DIMABLE / ROJO LACADO BRILLANTE
DIMMING BALLAST / RED BRILLIANT LACQUER

Acabados: Poliuretano acabado lacado brillante
Finishing: Polyurethane/brilliant lacquer finish



ACABADOS / FINISHING

LACADO ROJO LACADO BLANCO LACADO NEGRO
RED LACQUER WHITE LACQUER BLACK LACQUER









CARLOTA

APLIQUE
WALL LAMP



1 x 42 W Classic P ECO E-27

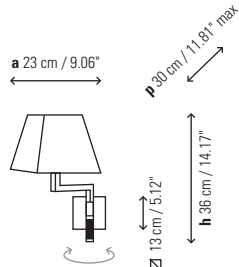

CARLOTA - G

APLIQUE
WALL LAMP



1 x 42 W Classic P ECO E-27

1 x 11 W E-27

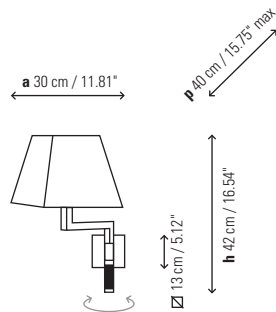

CARLOTA - DOBLE ARTICULADO

APLIQUE
WALL LAMP



1 x 42 W Classic P ECO E-27

1 x 11 W E-27

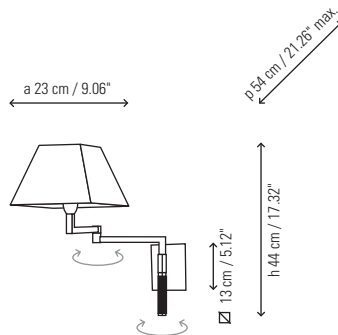

- 1024005 NÍQUEL SATINADO / SATIN NICKEL
- 1024006 CROMO BRILLANTE / BRILLIANT CHROME
- 1024060 NÍQUEL PIEL OSCURA / NICKEL DARK LEATHER
- 1024061 NÍQUEL PIEL CUERO / NICKEL CUIR LEATHER

Pantalla cuadrada 20 x 15 x 10 cm / Square lampshade 7.87" x 5.91" x 3.94"

- P-107 COTONET / COTTON
- P-202 CINTA TRANSLÚCIDA BLANCA / WHITE TRANSLUCENT RIBBON
- P-203 CINTA TRANSLÚCIDA CREMA / CREAM TRANSLUCENT RIBBON

Caja soporte \varnothing 11 cm / Surface back box \varnothing 4.33"
Brazo móvil / Swivel arm

- 1524005 NÍQUEL SATINADO / SATIN NICKEL
- 1524006 CROMO BRILLANTE / BRILLIANT CHROME
- 1524060 NÍQUEL PIEL OSCURA / NICKEL DARK LEATHER
- 1524061 NÍQUEL PIEL CUERO / NICKEL CUIR LEATHER

Pantalla cuadrada 23 x 17 x 12 cm / Square lampshade 9.06" x 6.69" x 4.72"

- P-487 COTONET / COTTON
- P-486 CINTA TRANSLÚCIDA BLANCA / WHITE TRANSLUCENT RIBBON
- P-489 CINTA TRANSLÚCIDA CREMA / CREAM TRANSLUCENT RIBBON

Caja soporte \varnothing 11 cm / Surface back box \varnothing 4.33"
Brazo móvil / Swivel arm

- 0924005 NÍQUEL SATINADO / SATIN NICKEL
- 0924006 CROMO BRILLANTE / BRILLIANT CHROME
- 0924060 NÍQUEL PIEL OSCURA / NICKEL DARK LEATHER
- 0924061 NÍQUEL PIEL CUERO / NICKEL CUIR LEATHER

Pantalla cuadrada 23 x 17 x 12 cm / Square lampshade 9.06" x 6.69" x 4.72"

- P-487 COTONET / COTTON
- P-486 CINTA TRANSLÚCIDA BLANCA / WHITE TRANSLUCENT RIBBON
- P-489 CINTA TRANSLÚCIDA CREMA / CREAM TRANSLUCENT RIBBON

Caja soporte \varnothing 11 cm / Surface back box \varnothing 4.33"
Brazo móvil / Swivel arm

ACABADOS / FINISHING

COTONET COTTON
CINTA CREMA CREAM RIBBON
CINTA BLANCA WHITE RIBBON



FAMÍLIA / FAMILY

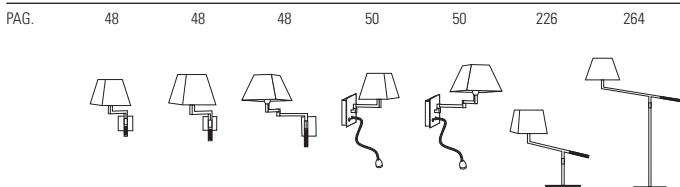

CROMO BRILLANTE BRILLIANT CHROME
NÍQUEL SATINADO SATIN NICKEL
PIEL OSCURA DARK LEATHER
PIEL CLARA CARAMEL LEATHER

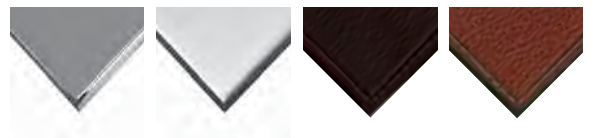



CARLOTA - G FL

APLIQUE
WALL LAMP



1 x 42 W Classic P ECO E-27

1 x 11 W E-27

1 x 1.2 W LED
Led: 1.2 W Phillips
Óptica / Optics: 45°
Lumens: 85 lm
Grados Kelvin 2.900°
Degrees Kelvin: 2.900°
Valor cromático / CRI: 85

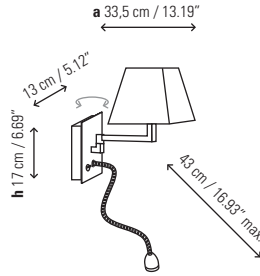

- F524005 NÍQUEL SATINADO / SATIN NICKEL
- F524006 CROMO BRILLANTE / BRILLIANT CHROME
- F524060 NÍQUEL PIEL OSCURA / NICKEL DARK LEATHER
- F524061 NÍQUEL PIEL CUERO / NICKEL CUIR LEATHER

Pantalla 23 x 17 x 12 cm / Lampshade 9.06" x 6.69" x 4.72"

- P-487 COTONET / COTTON
- P-486 CINTA TRANSLÚCIDA BLANCA / WHITE TRANSLUCENT RIBBON
- P-489 CINTA TRANSLÚCIDA CREMA / CREAM TRANSLUCENT RIBBON

Caja soporte 11 x 15 cm / Surface back box 4.33" x 5.91"

Brazo móvil / Swivel arm

Flexo de latón para asegurar una mayor flexibilidad y rigidez
Flexo made in brass to ensure greater flexibility and rigidity.

CARLOTA - DOBLE FL

APLIQUE
WALL LAMP



1 x 42 W Classic P ECO E-27

1 x 11 W E-27

1 x 1.2 W LED
Led: 1.2 W Phillips
Óptica / Optics: 45°
Lumens: 85 lm
Grados Kelvin 2.900°
Degrees Kelvin: 2.900°
Valor cromático / CRI: 85

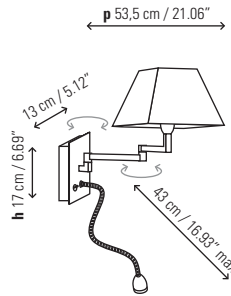

- F924005 NÍQUEL SATINADO / SATIN NICKEL
- F924006 CROMO BRILLANTE / BRILLIANT CHROME
- F924060 NÍQUEL PIEL OSCURA / NICKEL DARK LEATHER
- F924061 NÍQUEL PIEL CUERO / NICKEL CUIR LEATHER

Pantalla 23 x 17 x 12 cm / Lampshade 9.06" x 6.69" x 4.72"

- P-487 COTONET / COTTON
- P-486 CINTA TRANSLÚCIDA BLANCA / WHITE TRANSLUCENT RIBBON
- P-489 CINTA TRANSLÚCIDA CREMA / CREAM TRANSLUCENT RIBBON

Caja soporte 11 x 15 cm / Surface back box 4.33" x 5.91"

Brazo móvil / Swivel arm

Flexo de latón para asegurar una mayor flexibilidad y rigidez
Flexo made in brass to ensure greater flexibility and rigidity.

ACABADOS / FINISHING

COTONET
COTTON

CINTA CREMA
CREAM RIBBON

CINTA BLANCA
WHITE RIBBON



FAMÍLIA / FAMILY

PAG. 48 48 48 50 50 226 264

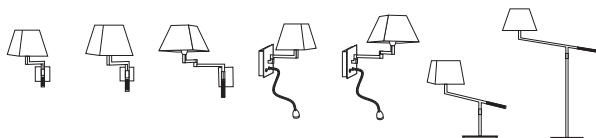

CROMO BRILLANTE
BRILLIANT CHROME

NÍQUEL SATINADO
SATIN NICKEL

PIEL OSCURA
DARK LEATHER

PIEL CLARA
CAMEL LEATHER

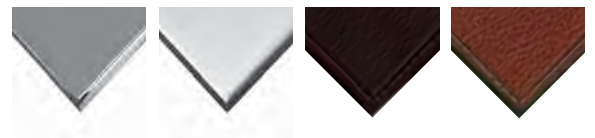



CLUB - A

APLIQUE
WALL LAMP



1 x 42 W Classic P ECO E-27

1 x 11 W E-27

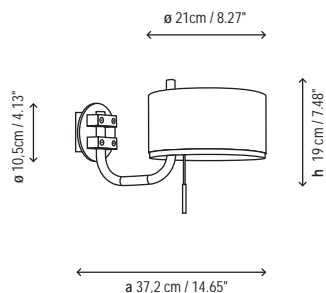

1532812 NEGRO MATE-NÍQUEL / MATTE BLACK-NICKEL

PANTALLA / LAMPSHADE

Pantalla aluminio negro / *Black aluminum shade*
Interior PVC blanco B1 Flame Resistant
White PVC interior B1 Flame Resistant
Incluye difusor superior de aluminio
Included aluminum top diffuser

Brazo fijo / Fixed arm

Interruptor en portalamparas / *Lampholder switch*

CLUB - A2L

APLIQUE
WALL LAMP



2 x 42 W Classic P ECO E-14

2 x 11 W E-14

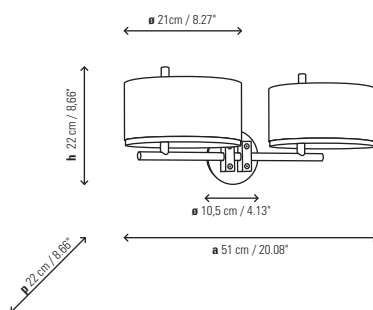

1232812 NEGRO MATE-NÍQUEL / MATTE BLACK-NICKEL

PANTALLA / LAMPSHADE

Pantalla aluminio negro / *Black aluminum shade*
Interior PVC blanco B1 Flame Resistant
White PVC interior B1 Flame Resistant
Incluye difusor superior de aluminio
Included aluminum top diffuser



FAMÍLIA / FAMILY

PAG. 52 52 108 228 266

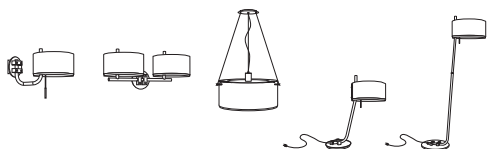

ACABADOS / FINISHING

NEGRO MATE
MATTE BLACK

NÍQUEL SATINADO
SATIN NICKEL





FLEXP

APLIQUE
WALL LAMP



1 x 1.2 W LED
 Led: 1.2 W Phillips
 Óptica / Optics: 45°
 Lumens: 85 lm
 Grados Kelvin 2.900°
 Degrees Kelvin: 2.900°
 Valor cromático / CRI: 85

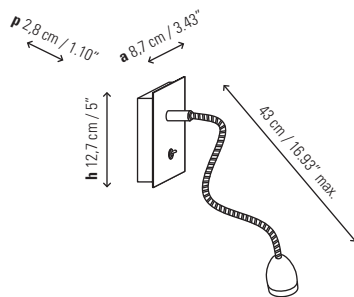

- FL25106 CROMO / CHROME
- FL25105 NÍQUEL SATINADO / SATIN NICKEL
- FL25160 NÍQUEL PIEL OSCURA / NICKEL DARK LEATHER
- FL25161 NÍQUEL PIEL CUERO / NICKEL CARAMEL LEATHER
- FL25116 CROMO CRISTAL ROJO / RED GLASS CHROME
- FL25117 CROMO CRISTAL NEGRO / BLACK GLASS CHROME

Flexo realizado en latón para mayor flexibilidad y garantía de rigidez. Cabezal de aluminio, interruptor de encendido en la base
Flexo made in brass to ensure greater flexibility and rigidity. Aluminium hood and switch on back plate.

Caja soporte 10,8 x 6,7 cm / Surface back box 4.25" x 2.64"

Fotometría disponible / Photometry available



ACABADOS / FINISHING





FLEXO LEXA

APLIQUE
WALL LAMP



1 x 1.2 W LED
Led: 1.2 W Phillips
Óptica / Optics: 45°
Lumens: 85 lm
Grados Kelvin 2.900°
Degrees Kelvin: 2.900°
Valor cromático / CRI: 85

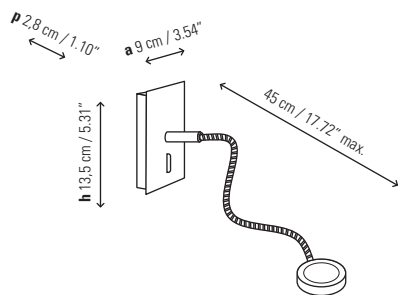

FL20505 NÍQUEL SATINADO / SATIN NICKEL
FL20506 CROMO BRILLANTE / BRILLIANT CHROME
FL20508 CROMO-NEGRO / BLACK CHROME

Flexo realizado en latón para mayor flexibilidad y garantía de rigidez. Cabezal de inyección de Zamac, interruptores de encendido en la base

Flexo made in brass to ensure greater flexibility and rigidity, with Zamac injection. Hood and switch on back plate.

Caja soporte 12 x 8 cm / Surface back box 4.72" x 3.15"

Fotometría disponible / Photometry available



ACABADOS / FINISHING

CROMO BRILLANTE
BRILLIANT CHROME

NÍQUEL SATINADO
SATIN NICKEL

CROMO NEGRO
BLACK CHROME





KLAR

APLIQUE
WALL LAMP



 1 x 48 W G-9 (HALOPIN ECO)

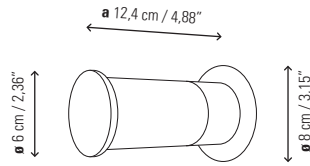

1125421 CROMO CRISTAL OPAL / CHROME OPAL GLASS



ACABADOS / FINISHING

CROMO BRILLANTE
BRILLIANT CHROME

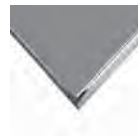



KLEINE

APLIQUE
WALL LAMP



 1 x 48 W G-9 (HALOPIN ECO)

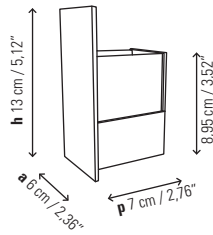

1125320 INOX PULIDO CRISTAL OPAL / *POLISHED INOX OPAL GLASS*
1125321 INOX SATINADO CRISTAL OPAL / *SATIN INOX OPAL GLASS*



ACABADOS / FINISHING

INOX PULIDO
POLISHED INOX

INOX SATINADO
SATIN INOX

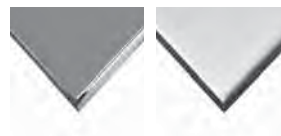



LEA

APLIQUE
WALL LAMP



1 x 18 W G-24 q-2

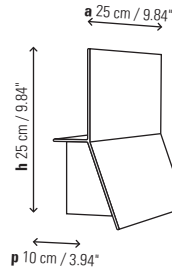

LEA - 01

APLIQUE
WALL LAMP



1 x 24 W T5
fluorescente/fluorescent

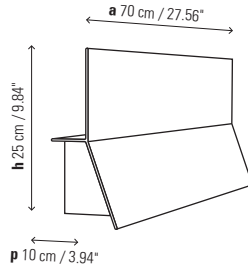

LEA - 02

APLIQUE
WALL LAMP



1 x 39 W T5
fluorescente/fluorescent

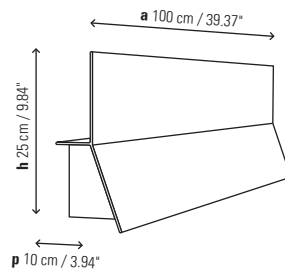

LEA - 03

APLIQUE
WALL LAMP



1 x 54 W T5
fluorescente/fluorescent

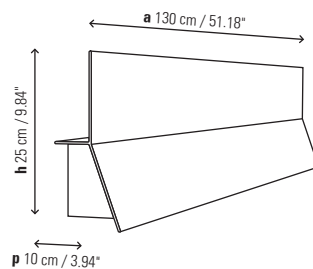

0021501 BLANCO / WHITE

Incluye difusor policarbonato / Polycarbonate diffuser included

Colores especiales: Por favor, indiquen el nº de RAL.

Cantidad mínima: 30 unidades.

Special colors: RAL number to be indicated.

Minimum quantity: 30 pieces.

0121501 REACTANCIA ELECTRÓNICA / BLANCO
ELECTRONIC BALLAST / WHITE

D0121501 REACTANCIA DIMABLE / BLANCO
DIMMING BALLAST / WHITE

Incluye difusor policarbonato / Polycarbonate diffuser included
Estante superior hasta 4 kg / Upper shelf bears until 4 kg

Colores especiales: Por favor, indiquen el nº de RAL.

Cantidad mínima: 30 unidades.

Special colors: RAL number to be indicated.

Minimum quantity: 30 pieces.

0221501 REACTANCIA ELECTRÓNICA / BLANCO
ELECTRONIC BALLAST / WHITE

D0221501 REACTANCIA DIMABLE / BLANCO
DIMMING BALLAST / WHITE

Incluye difusor policarbonato / Polycarbonate diffuser included
Estante superior hasta 4 kg / Upper shelf bears until 4 kg

Colores especiales: Por favor, indiquen el nº de RAL.

Cantidad mínima: 30 unidades.

Special colors: RAL number to be indicated.

Minimum quantity: 30 pieces.

0321501 REACTANCIA ELECTRÓNICA / BLANCO
ELECTRONIC BALLAST / WHITE

D0321501 REACTANCIA DIMABLE / BLANCO
DIMMING BALLAST / WHITE

Incluye difusor policarbonato / Polycarbonate diffuser included
Estante superior hasta 4 kg / Upper shelf bears until 4 kg

Colores especiales: Por favor, indiquen el nº de RAL.

Cantidad mínima: 30 unidades.

Special colors: RAL number to be indicated.

Minimum quantity: 30 pieces.



Interruptor opcional / Consultar
Optional switch / Consult

ACABADOS / FINISHING

BLANCO LEA
LEA WHITE









LEXA

APLIQUE
WALL LAMP



1 x 42 W Classic P ECO E-27

1 x 11 W E-27

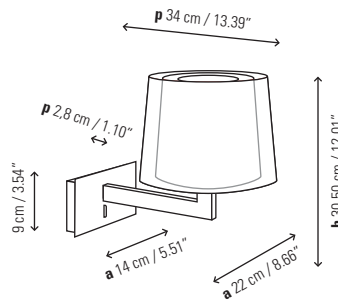
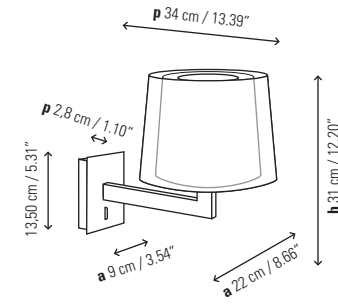

Caja vertical 9 x 13,5 cm / *Vertical Backplate-box 3.54" x 5.31"*
 1120505 NÍQUEL SATINADO / *SATIN NICKEL*
 1120506 CROMO BRILLANTE / *BRILLIANT CHROME*
 1120508 CROMO-NEGRO / *BLACK CHROME*

Caja horizontal 14 x 9 cm / *Horizontal Backplate-box 5.51" x 3.54"*
 1320505 NÍQUEL SATINADO / *SATIN NICKEL*
 1320506 CROMO BRILLANTE / *BRILLIANT CHROME*
 1320508 CROMO-NEGRO / *BLACK CHROME*

Pantalla exterior 22 x 16 x 18 cm / *Outer lampshade 8.66" x 6.30" x 7.09"*
 P-633E COTONET BLANCO / *WHITE COTTON*
 Pantalla algodón sin tapa superior / *Cotton shade without upper diffuser*

P-634E CINTA TRANSLÚCIDA BLANCA / *WHITE TRANSLUCENT RIBBON*
 P-635E CINTA TRANSLÚCIDA CREMA / *CREAM TRANSLUCENT RIBBON*

P-636E MALLA NEGRA / *BLACK MESH*
 P-637E MALLA ROJA / *RED MESH*

Exterior pantalla de PVC cristal / *Outer lampshade: PVC cristal*

Pantalla interior / *Inner lampshade*
 P-636I MALLA NEGRA / *BLACK MESH*
 P-637I MALLA ROJA / *RED MESH*

Interior pantalla de film poliéster rígido resistente al calor
Inner shade made of a fireresistent polyester rigid film

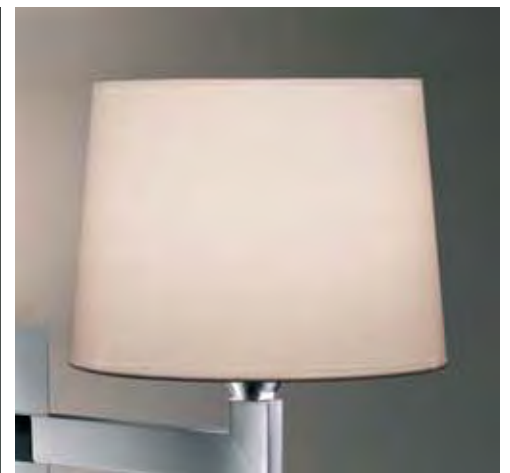

ACABADOS / FINISHING









LEXA FL

APLIQUE
WALL LAMP



1 x 42 W Classic P ECO E-27

1 x 11 W E-27

1 x 1.2 W LED
Led: 1.2 W Phillips
Óptica / Optics: 45°
Lumens: 85 lm
Grados Kelvin 2.900°
Degrees Kelvin: 2.900°
Valor cromático / CRI: 85

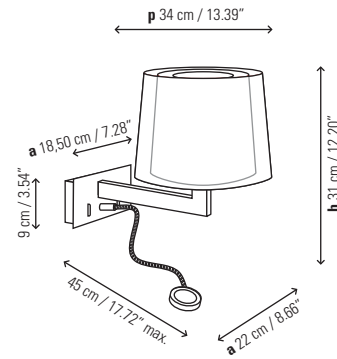
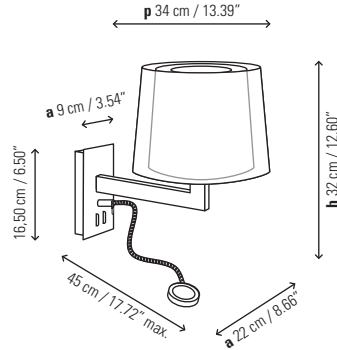

Caja vertical 9 x 16,5 cm / Vertical Backplate-box 3.54" x 6.50"
1220505 NÍQUEL SATINADO / SATIN NICKEL
1220506 CROMO BRILLANTE / BRILLIANT CHROME
1220508 CROMO-NEGRO / BLACK CHROME

Caja horizontal 18,5 x 9 cm / Horizontal Backplate-box 7.28" x 3.54"
1020505 NÍQUEL SATINADO / SATIN NICKEL
1020506 CROMO BRILLANTE / BRILLIANT CHROME
1020508 CROMO-NEGRO / BLACK CHROME

Flexo realizado en latón para mayor flexibilidad y garantía de rigidez. Cabezal de inyección de Zamac, interruptores de encendido en la base
Flexo made in brass to ensure greater flexibility and rigidity, with Zamac injection. Hood and switch on back plate.

Pantalla exterior 22 x 16 x 18 cm / Outer lampshade 8.66" x 6.30" x 7.09"
P-633E COTONET BLANCO / WHITE COTTON
Pantalla algodón sin tapa superior / Cotton shade without upper diffuser

P-634E CINTA TRANSLÚCIDA BLANCA / WHITE TRANSLUCENT RIBBON
P-635E CINTA TRANSLÚCIDA CREMA / CREAM TRANSLUCENT RIBBON

P-636E MALLA NEGRA / BLACK MESH

P-637E MALLA ROJA / RED MESH

Exterior pantalla de PVC cristal / Outer lampshade: PVC cristal

Pantalla interior / Inner lampshade

P-636I MALLA NEGRA / BLACK MESH

P-637I MALLA ROJA / RED MESH

Interior pantalla de film poliéster rígido resistente al calor
Inner shade made of a fireresistent polyester rigid film



ACABADOS / FINISHING

CROMO BRILLANTE
BRILLIANT CHROME

NÍQUEL SATINADO
SATIN NICKEL

CROMO NEGRO
BLACK CHROME

MALLA NEGRA
BLACK MESH

MALLA ROJA
RED MESH

COTONET BLANCO
COTTON WHITE

CINTA CREMA
CREAM RIBBON

CINTA BLANCA
WHITE RIBBON

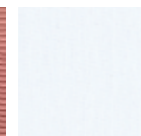
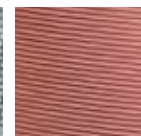
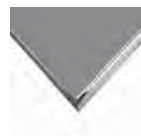



LIBAN

APLIQUE
WALL LAMP



 1 x 120 W R7S 118 mm

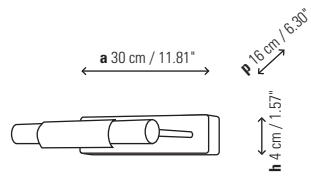

1118605 NÍQUEL SATINADO / *SATIN NICKEL*
1118606 CROMO BRILLANTE / *BRILLIANT CHROME*

Caja soporte 28 x 4 cm / *Surface back box 11.02" x 1.57"*

ACABADOS / FINISHING

CROMO BRILLANTE / *BRILLIANT CHROME* NÍQUEL SATINADO / *SATIN NICKEL*

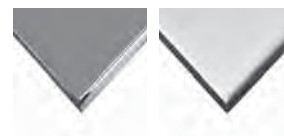



MEI OVAL - 01

APLIQUE
WALL LAMP



1 x 42 W Classic P ECO E-27

1 x 11 W E-27
Duluxstar mini twist

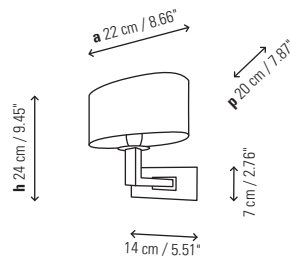

- 0125005 NÍQUEL SATINADO / SATIN NICKEL
- 0125006 CROMO BRILLANTE / BRILLIANT CHROME
- 0125060 NÍQUEL PIEL OSCURA / NICKEL DARK LEATHER
- 0125061 NÍQUEL PIEL CUERO / NICKEL CARAMEL LEATHER
- 0125017 CROMO CRISTAL NEGRO / CHROME BLACK GLASS

Pantalla oval 21 x 14 x 13 cm / Oval lampshade 8.27" x 5.51" x 5.12"
La pantalla con difusor solo admite bombillas ECO-CLASSIC.
NO son aptas las bombillas compactas.
Shade with upper difusser can only go with ECO-CLASSIC bulbs.
NOT suitable with compact bulbs.

- P-600 CINTA TRANSLÚCIDA BLANCA / WHITE TRANSLUCENT RIBBON
- P-601 CINTA TRANSLÚCIDA CREMA / CREAM TRANSLUCENT RIBBON
- P-602 CINTA TRANSLÚCIDA NEGRA / BLACK TRANSLUCENT RIBBON
- P-603 COTONET BLANCO / WHITE COTTON

MEI OVAL - 02

APLIQUE
WALL LAMP



1 x 42 W Classic P ECO E-27

1 x 11 W E-27
Duluxstar mini twist

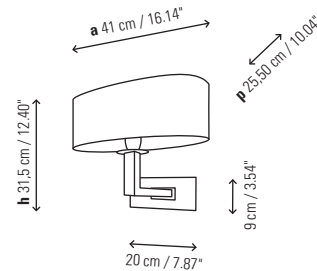

- 1125005 NÍQUEL SATINADO / SATIN NICKEL
- 1125006 CROMO BRILLANTE / BRILLIANT CHROME
- 1125060 NÍQUEL PIEL OSCURA / NICKEL DARK LEATHER
- 1125061 NÍQUEL PIEL CUERO / NICKEL CARAMEL LEATHER
- 1125017 CROMO CRISTAL NEGRO / CHROME BLACK GLASS

Pantalla oval 41 x 17,5 x 15 cm / Oval lampshade 16.14" x 6.89" x 5.91"
La pantalla con difusor solo admite bombillas ECO-CLASSIC.
NO son aptas las bombillas compactas.
Shade with upper difusser can only go with ECO-CLASSIC bulbs.
NOT suitable with compact bulbs.

- P-551 CINTA TRANSLÚCIDA BLANCA / WHITE TRANSLUCENT RIBBON
- P-552 CINTA TRANSLÚCIDA CREMA / CREAM TRANSLUCENT RIBBON
- P-553 CINTA TRANSLÚCIDA NEGRA / BLACK TRANSLUCENT RIBBON
- P-554 COTONET BLANCO / WHITE COTTON

La pantalla estándar no incluye difusor negro de cristal. Véase pantalla Mei Oval mesa.
Standard shade does not include the black glass diffuser. See Mei Oval mesa shade for reference.

ACABADOS / FINISHING



FAMILIA / FAMILY

PAG. 74 74 156 240 276

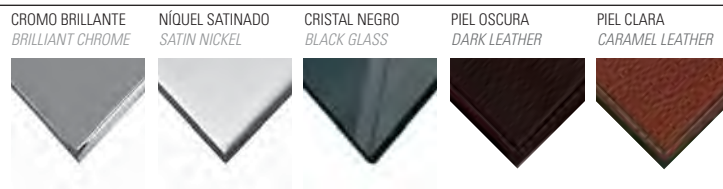
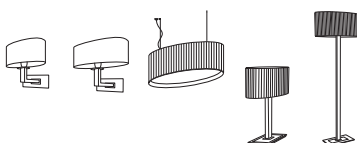







PLANA - 01

APLIQUE
WALL LAMP



1 x 80 W R7S 78 mm

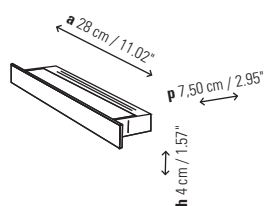

- 1119805 NÍQUEL SATINADO / SATIN NICKEL
- 1119806 CROMO BRILLANTE / BRILLIANT CHROME
- 1119820 NÍQUEL CRISTAL OPAL / NICKEL OPAL GLASS
- 1119821 CROMO CRISTAL OPAL / CHROME OPAL GLASS

PLANA - 02

APLIQUE
WALL LAMP



2 x 80 W R7S 78 mm

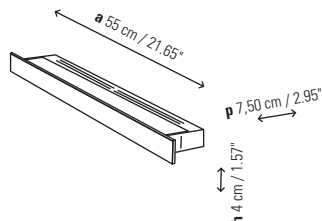

- 1219805 NÍQUEL SATINADO / SATIN NICKEL
- 1219806 CROMO BRILLANTE / BRILLIANT CHROME
- 1219820 NÍQUEL CRISTAL OPAL / NICKEL OPAL GLASS
- 1219821 CROMO CRISTAL OPAL / CHROME OPAL GLASS

PLANA - T5

APLIQUE
WALL LAMP



2 x 24 W T5
Reactancia electrónica

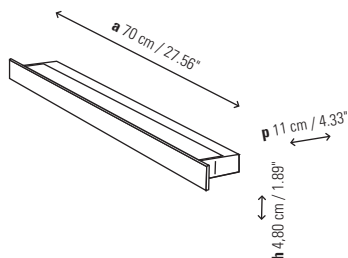

- T519805 NÍQUEL SATINADO / SATIN NICKEL
- T519806 CROMO BRILLANTE / BRILLIANT CHROME

Fotometría disponible / Photometry available



ACABADOS / FINISHING

CROMO BRILLANTE / BRILLIANT CHROME NÍQUEL SATINADO / SATIN NICKEL

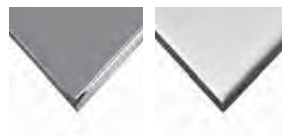









DESIGN PLUS

SILANTRA COLLECTION
AWARDED WITH DESIGN PLUS
PRIZE (L+B, FRANKFURT) 2006.

SILANTRA > 83



SILANTRA - 01

APLIQUE
WALL LAMP



1 x 80 W R7S 78 mm

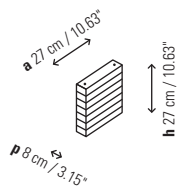

SILANTRA - 02

APLIQUE
WALL LAMP



1 x 80 W R7S 118 mm

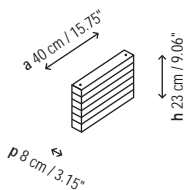

SILANTRA - 03

APLIQUE
WALL LAMP



1 x 120 W R7S 118 mm

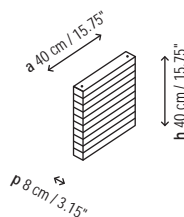

SILANTRA - 03

APLIQUE
WALL LAMP



2 x 18 W 2G-11
Fluorencencia (TCL)

1245525 ALUMINIO PULIDO-CINTA TRANSLÚCIDA CREMA
POLISHED ALUMINIUM-CREAM TRANSLUCENT RIBBON

1245526 ALUMINIO PULIDO-CINTA TRANSLÚCIDA BLANCA
POLISHED ALUMINIUM-WHITE TRANSLUCENT RIBBON

Pantalla 27 x 27 cm / *Lampshade 10.63" x 10.63"*

2245527 ALUMINIO PULIDO-CINTA TRANSLÚCIDA CREMA
POLISHED ALUMINIUM-CREAM TRANSLUCENT RIBBON

2245528 ALUMINIO PULIDO-CINTA TRANSLÚCIDA BLANCA
POLISHED ALUMINIUM-WHITE TRANSLUCENT RIBBON

Pantalla 40 x 23 cm / *Lampshade 15.75" x 9.06"*

H245529 ALUMINIO PULIDO-CINTA TRANSLÚCIDA CREMA
(HALÓGENO)
*POLISHED ALUMINIUM-CREAM TRANSLUCENT RIBBON
(HALOGEN)*

H245530 ALUMINIO PULIDO-CINTA TRANSLÚCIDA BLANCA
(HALÓGENO)
*POLISHED ALUMINIUM-WHITE TRANSLUCENT RIBBON
(HALOGEN)*

Pantalla 40 x 40 cm / *Lampshade 15.75" x 15.75"*

F245529 ALUMINIO PULIDO-CINTA TRANSLÚCIDA CREMA
(FLUORESCENTE)
*POLISHED ALUMINIUM-CREAM TRANSLUCENT RIBBON
(FLUORESCENT)*

F245530 ALUMINIO PULIDO-CINTA TRANSLÚCIDA BLANCA
(FLUORESCENTE)
*POLISHED ALUMINIUM-WHITE TRANSLUCENT RIBBON
(FLUORESCENT)*

Pantalla 40 x 40 cm / *Lampshade 15.75" x 15.75"*

No dimable / *No dimmable*

Fotometría disponible / *Photometry available*

FAMÍLIA / FAMILY

PAG. 84 84 84 86 86 86 176

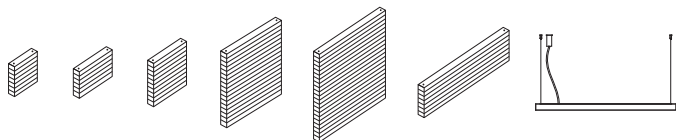

ACABADOS / FINISHING

ALUMINIO PULIDO *POLISHED ALUMINIUM* CINTA CREMA *CREAM RIBBON* CINTA BLANCA *WHITE RIBBON*





SILANTRA - 04

APLIQUE - PLAFÓN
WALL LAMP - CEILING



4 x 24 W T5 Fluorescente

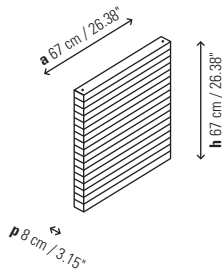

- 4245531 REACTANCIA ELECTRÓNICA / CINTA TRANSLÚCIDA CREMA
ELECTRONIC BALLAST / CREAM TRANSLUCENT RIBBON
- 4245532 REACTANCIA ELECTRÓNICA / CINTA TRANSLÚCIDA BLANCA
ELECTRONIC BALLAST / WHITE TRANSLUCENT RIBBON
- D4245531 REACTANCIA DIMABLE / CINTA TRANSLÚCIDA CREMA
DIMMING BALLAST / CREAM TRANSLUCENT RIBBON
- D4245532 REACTANCIA DIMABLE / CINTA TRANSLÚCIDA BLANCA
DIMMING BALLAST / WHITE TRANSLUCENT RIBBON

Aluminio pulido / Polished aluminium
Pantalla 67 x 67 cm / Lampshade 26.38" x 26.38"

Fotometría disponible / Photometry available

SILANTRA - 05

APLIQUE - PLAFÓN
WALL LAMP - CEILING



4 x 39 W T5 Fluorescente

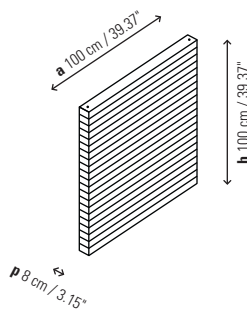

- 5245533 REACTANCIA ELECTRÓNICA / CINTA TRANSLÚCIDA CREMA
ELECTRONIC BALLAST / CREAM TRANSLUCENT RIBBON
- 5245534 REACTANCIA ELECTRÓNICA / CINTA TRANSLÚCIDA BLANCA
ELECTRONIC BALLAST / WHITE TRANSLUCENT RIBBON
- D5245533 REACTANCIA DIMABLE / CINTA TRANSLÚCIDA CREMA
DIMMING BALLAST / CREAM TRANSLUCENT RIBBON
- D5245534 REACTANCIA DIMABLE / CINTA TRANSLÚCIDA BLANCA
DIMMING BALLAST / WHITE TRANSLUCENT RIBBON

Aluminio pulido / Polished aluminium
Pantalla 100 x 100 cm / Lampshade 39.37" x 39.37"

Fotometría disponible / Photometry available

SILANTRA - 06

APLIQUE - PLAFÓN
WALL LAMP - CEILING



2 x 39 W T5 Fluorescente

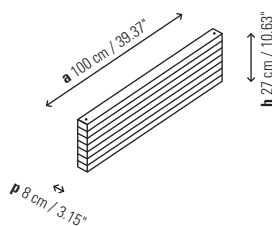

- 6245535 REACTANCIA ELECTRÓNICA / CINTA TRANSLÚCIDA CREMA
ELECTRONIC BALLAST / CREAM TRANSLUCENT RIBBON
- 6245536 REACTANCIA ELECTRÓNICA / CINTA TRANSLÚCIDA BLANCA
ELECTRONIC BALLAST / WHITE TRANSLUCENT RIBBON
- D6245535 REACTANCIA DIMABLE / CINTA TRANSLÚCIDA CREMA
DIMMING BALLAST / CREAM TRANSLUCENT RIBBON
- D6245536 REACTANCIA DIMABLE / CINTA TRANSLÚCIDA BLANCA
DIMMING BALLAST / WHITE TRANSLUCENT RIBBON

Aluminio pulido / Polished aluminium
Pantalla 100 x 27 cm / Lampshade 39.37" x 10.63"

Fotometría disponible / Photometry available

FAMÍLIA / FAMILY

PAG. 84 84 84 86 86 86 176

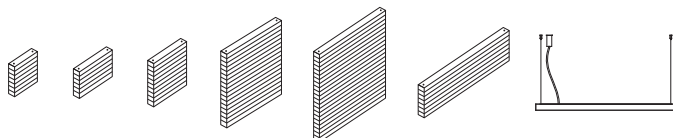

ACABADOS / FINISHING

ALUMINIO PULIDO / POLISHED ALUMINIUM CINTA CREMA / CREAM RIBBON CINTA BLANCA / WHITE RIBBON









SPOCK - A

APLIQUE
WALL LAMP



4 x 1.2 W LED
 Led: 4 x 1.2 W = 4.8 Phillips
 Óptica / Optics: 45°
 Lumens: 85 x 4 = 340 lm
 Grados Kelvin 2.900°
 Degrees Kelvin: 2.900°
 Valor cromático / CRI: 85

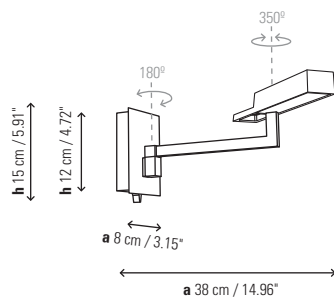

- 1110505L NÍQUEL / NICKEL
- 1110506L CROMO / CHROME
- 1110511L CROMO-BLANCO / CHROME-WHITE
- 1110510L CROMO-GRAFITO / CHROME-GRAPHITE

Fotometría disponible / Photometry available



FAMÍLIA / FAMILY

PAG. 90 252 252 280

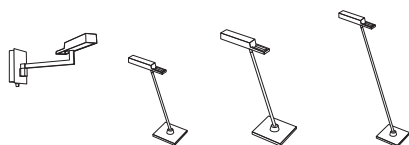

ACABADOS / FINISHING

CROMO BRILLANTE / BRILLIANT CHROME NÍQUEL SATINADO / SATIN NICKEL BLANCO / WHITE GRAFITO / GRAPHITE

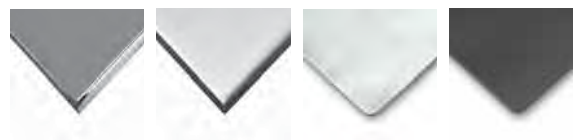



TIMEA - A

APLIQUE
WALL LAMP



1 x 120 WR7S 118 mm

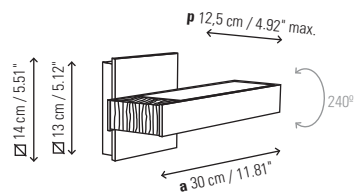

- 1025505 NÍQUEL SATINADO / SATIN NICKEL
- 1025506 CROMO BRILLANTE / BRILLIANT CHROME
- 1025519 CROMO-NEGRO / BLACK-CHROME

- 102550535 NÍQUEL MADERA / WOOD NICKEL
- 102550635 CROMO MADERA / WOOD CHROME
- 102551935 CROMO-NEGRO MADERA / WOOD BLACK-CHROME

Pantalla inyección de Zamac orientable. Rotación de giro 240°
 240° orientable Zamac injected hood
 Incluye difusor interior cristal / Interior opal glass
 Madera de fresno - color nogal / Ash tree - walnut coloured

Versión Led disponible próximamente
 Led source soon available please consult



FAMÍLIA / FAMILY

PAG. 92 286

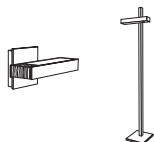

ACABADOS / FINISHING





TWALL

APLIQUE
WALL LAMP



2 x 60 W G-9 (HALOPIN ECO)

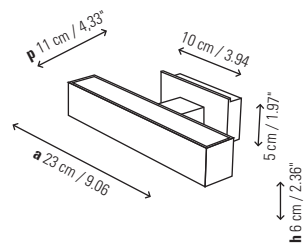

1119705 NÍQUEL SATINADO / SATIN NICKEL
1119706 CROMO BRILLANTE / BRILLIANT CHROME



ACABADOS / FINISHING

CROMO BRILLANTE / BRILLIANT CHROME
NÍQUEL SATINADO / SATIN NICKEL

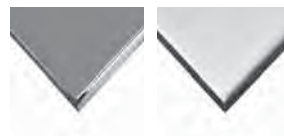



WALL STREET

APLIQUE
WALL LAMP



1 x 28 W Classic P ECO E-27

1 x 14 W E-27

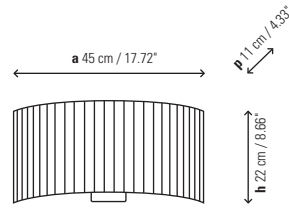

- 1118505 NÍQUEL SATINADO / SATIN NICKEL
- 1118504 HIERRO NEGRO / BLACK IRON
- 1118503 HIERRO MARRÓN GRAFITO / GRAPHITE BROWN IRON

Pantalla 45 x 22 cm / Lampshade 17.72" x 8.66"

- P-294 PERGAMINO / PARCHMENT
- P-295 PLISADA / PLEATED
- P-296 COTONET / COTTON
- P-297 COTONET BLANCO / WHITE COTTON
- P-298 CINTA TRANSLÚCIDA CREMA / CREAM TRANSLUCENT RIBBON
- P-299 CINTA TRANSLÚCIDA BLANCA / WHITE TRANSLUCENT RIBBON

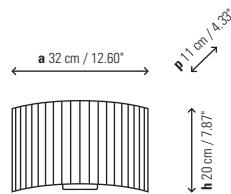

Pantalla 32 x 20 cm / Lampshade 12.60" x 7.87"

- P-335 PERGAMINO / PARCHMENT
- P-338 PLISADA / PLEATED
- P-339 COTONET / COTTON
- P-332 COTONET BLANCO / WHITE COTTON
- P-333 CINTA TRANSLÚCIDA CREMA / CREAM TRANSLUCENT RIBBON
- P-334 CINTA TRANSLÚCIDA BLANCA / WHITE TRANSLUCENT RIBBON



1 x 28 W Classic P ECO E-27

1 x 8 W E-27 Duluxstar mini twist

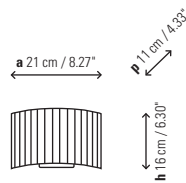

Pantalla 21 x 16 cm / Lampshade 8.27" x 6.30"

- P-343 PERGAMINO / PARCHMENT
- P-346 PLISADA / PLEATED
- P-347 COTONET / COTTON
- P-342 COTONET BLANCO / WHITE COTTON
- P-355 CINTA TRANSLÚCIDA CREMA / CREAM TRANSLUCENT RIBBON
- P-356 CINTA TRANSLÚCIDA BLANCA / WHITE TRANSLUCENT RIBBON

Caja soporte 8 x 5 cm / Surface back box 3.15" x 1.97"



ACABADOS / FINISHING

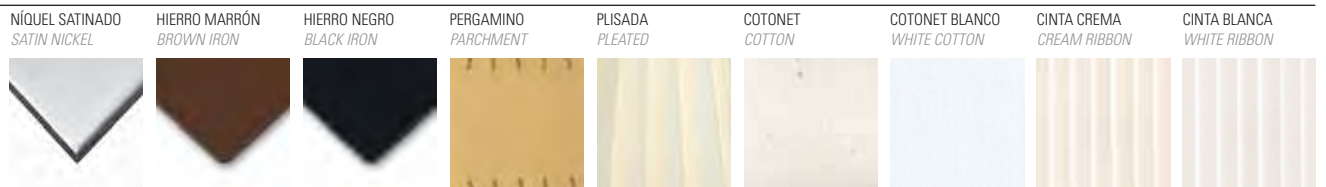



WALL STREET FL

APLIQUE
WALL LAMP



1 x 42 W Classic P ECO E-27

1 x 14 W E-27

1 x 1.2 W LED
Led: 1.2 W Phillips
Óptica / Optics: 45°
Lumens: 85 lm
Grados Kelvin 2.900°
Degrees Kelvin: 2.900°
Valor cromático / CRI: 85

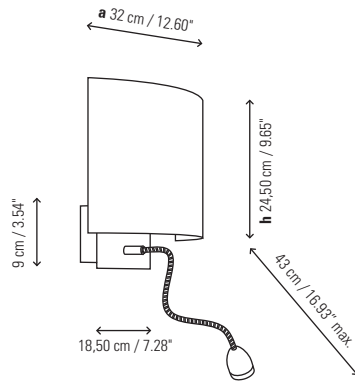

1118505FL NIQUEL SATINADO / SATIN NICKEL
1118506FL CROMO BRILLANTE / BRILLIANT CHROME

Pantalla 32 x 20 cm / lampshade 12.60" x 7.87"

P-335 PERGAMINO / PARCHMENT
P-338 PLISADA / PLEATED
P-339 COTONET / COTTON
P-332 COTONET BLANCO / WHITE COTTON
P-333 CINTA TRANSLÚCIDA CREMA / CREAM TRANSLUCENT RIBBON
P-334 CINTA TRANSLÚCIDA BLANCA / WHITE TRANSLUCENT RIBBON

Caja soporte: 17 x 7.5 cm / Surface back box: 6.69" x 2.95"
Flexo de latón para asegurar una mayor flexibilidad y rigidez
Flexo made in brass to ensure greater flexibility and rigidity

ACABADOS / FINISHING

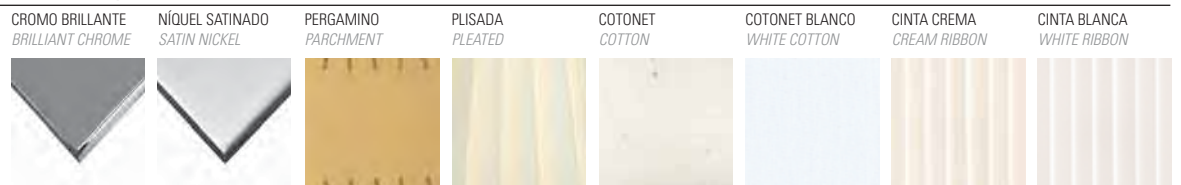



WALL STREET T5 - 01

APLIQUE
WALL LAMP



2 x 24 W T5 Fluorescente
Reactancia electrónica

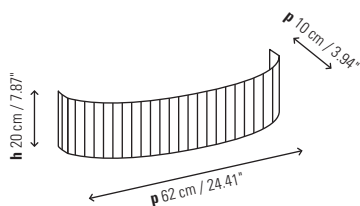

T529001 ESTRUCTURA BLANCA T-5/01 / WHITE STRUCTURE T-5/01

Pantalla T-5/01 / Lampshade T-5/01

P-605 COTONET BLANCO / WHITE COTTON

P-606 CINTA TRANSLÚCIDA BLANCA / WHITE TRANSLUCENT RIBBON

P-607 CINTA TRANSLÚCIDA CREMA / CREAM TRANSLUCENT RIBBON

Las medidas de este aplique van siempre en función de los fluorescentes T-5 HO

Wall lamp measures are according to T-5 HO Fluorescents

WALL STREET T5 - 02

APLIQUE
WALL LAMP



2 x 39 W T5 Fluorescente
Reactancia electrónica

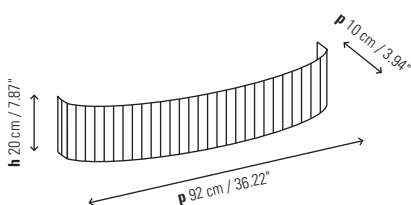

T529002 ESTRUCTURA BLANCA T-5/02 / WHITE STRUCTURE T-5/02

Pantalla T-5/02 / Lampshade T-5/02

P-611 COTONET BLANCO / WHITE COTTON

P-612 CINTA TRANSLÚCIDA BLANCA / WHITE TRANSLUCENT RIBBON

P-613 CINTA TRANSLÚCIDA CREMA / CREAM TRANSLUCENT RIBBON

Las medidas de este aplique van siempre en función de los fluorescentes T-5 HO

Wall lamp measures are according to T-5 HO Fluorescents

BIG FORMAT

ACABADOS / FINISHING

COTONET BLANCO
WHITE COTTON

CINTA CREMA
CREAM RIBBON

CINTA BLANCA
WHITE RIBBON







SUSPENSIÓN *PENDANT LAMP*



CALA
SUSPENSIÓN
PENDANT LAMP



4 x 42 W Classic P ECO E-27

4 x 22 W E-27

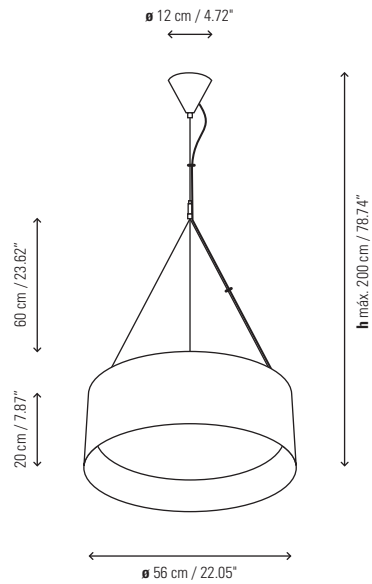

- 4132601 BLANCO LACADO BRILLANTE / WHITE BRILLIANT LACQUER
- 4132623 NEGRO LACADO BRILLANTE / BLACK BRILLIANT LACQUER
- 4132622 ROJO LACADO BRILLANTE / RED BRILLIANT LACQUER

Acabados: lacado brillante
Finishing: brilliant lacquer

Material: Poliuretano / Polyurethane

Altura regulable
Adjustable tensor wire

FAMÍLIA / FAMILY

PAG. 104 196

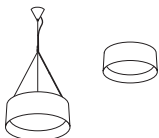

ACABADOS / FINISHING

LACADO ROJO
RED LACQUER

LACADO BLANCO
WHITE LACQUER

LACADO NEGRO
BLACK LACQUER









CLUB - S

SUSPENSIÓN
PENDANT LAMP



3 x 52 W Classic A ECO E-27

3 x 14 W E-27

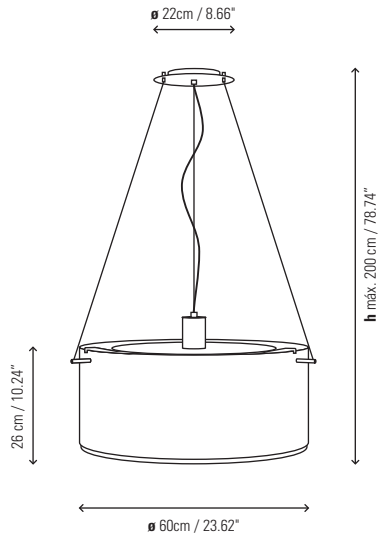

4132812 NEGRO MATE-NÍQUEL / MATTE BLACK-NICKEL

Pantalla aluminio negro

Black aluminum shade

Interior PVC blanco B1 Flame Resistant

White PVC interior B1 Flame Resistant

Incluye difusor superior de aluminio

Upper aluminum diffuser included

Incluye difusor inferior de cristal

Bottom glass diffuser included

Altura regulable

Adjustable tensor wire



FAMÍLIA / FAMILY

PAG. 52 52 108 228 266



ACABADOS / FINISHING

NÍQUEL SATINADO
SATIN NICKEL

NEGRO MATE
MATTE BLACK

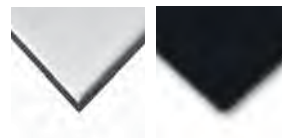



DANONA - 1 LUZ

SUSPENSIÓN
PENDANT LAMP



1 x 70 W Classic A ECO E-27

1 x 18 W E-27

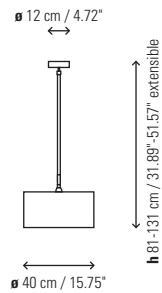

- 4123105 NÍQUEL SATINADO / SATIN NICKEL
- 4123160 NÍQUEL PIEL OSCURA / NICKEL DARK LEATHER
- 4123161 NÍQUEL PIEL CUERO / NICKEL CAMEL LEATHER

Pantalla 40 x 22 x 40 cm / Lampshade 15.75" x 8.66" x 15.75"

- P-416 COTONET / COTTON
- P-420 CINTA TRANSLÚCIDA BLANCA / WHITE TRANSLUCENT RIBBON
- P-421 CINTA TRANSLÚCIDA CREMA / CREAM TRANSLUCENT RIBBON

Pantalla con difusor superior / The shade includes upper diffuser

DANONA - 3 LUCES

SUSPENSIÓN
PENDANT LAMP



3 x 70 W Classic A ECO E-27

3 x 18 W E-27

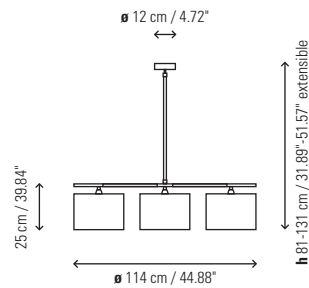

- 4323105 NÍQUEL SATINADO / SATIN NICKEL
- 4323160 NÍQUEL PIEL OSCURA / NICKEL DARK LEATHER
- 4323161 NÍQUEL PIEL CUERO / NICKEL CAMEL LEATHER

Pantalla 27 x 18 x 27 cm / Lampshade 10.63" x 7.09" x 10.63"

- P-150 COTONET / COTTON
- P-005C CINTA TRANSLÚCIDA CREMA / CREAM TRANSLUCENT RIBBON
- P-006C CINTA TRANSLÚCIDA BLANCA / WHITE TRANSLUCENT RIBBON



FAMÍLIA / FAMILY

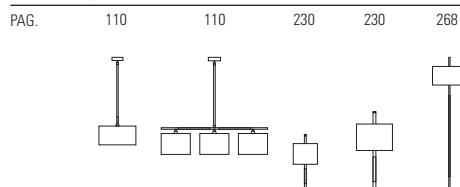

ACABADOS / FINISHING

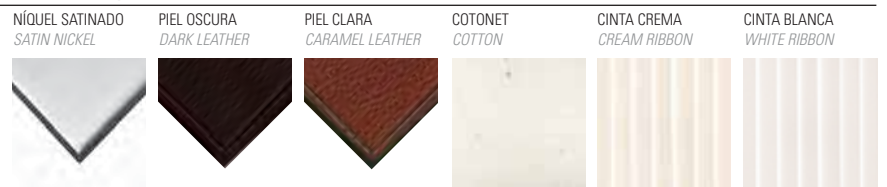







ELEA - 02

SUSPENSIÓN
PENDANT LAMP



4 x 42 W Classic P ECO E-27

4 x 22 W E-27

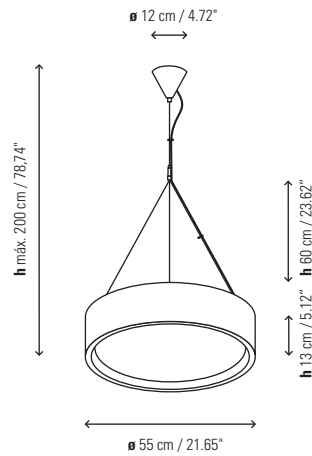

- 410232401 BLANCO LACADO BRILLANTE / *WHITE BRILLIANT LACQUER*
- 410232423 NEGRO LACADO BRILLANTE / *BLACK BRILLIANT LACQUER*
- 410232422 ROJO LACADO BRILLANTE / *RED BRILLIANT LACQUER*

Acabados: lacado brillante / *Finishing: brilliant lacquer*

Material: Poliuretano / *Polyurethane*

Difusor cristal óptico mate / *Optical glass diffuser*

ELEA - 03 / DIMABLE

SUSPENSIÓN
PENDANT LAMP



4 x 55 W 2G11

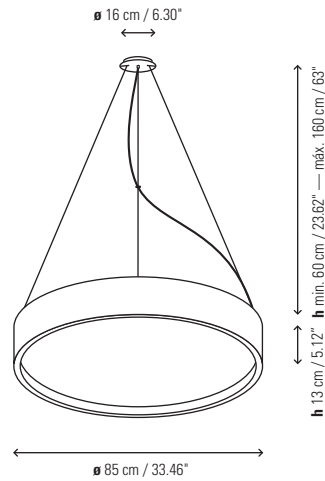

- 410332401 BLANCO LACADO BRILLANTE / *WHITE BRILLIANT LACQUER*
- 410332423 NEGRO LACADO BRILLANTE / *BLACK BRILLIANT LACQUER*
- 410332422 ROJO LACADO BRILLANTE / *RED BRILLIANT LACQUER*

D410332401 REACTANCIA DIMABLE-BLANCO LACADO BRILLANTE
DIMMING BALLAST-WHITE BRILLIANT LACQUER

D410332423 REACTANCIA DIMABLE-NEGRO LACADO BRILLANTE
DIMMING BALLAST-BLACK BRILLIANT LACQUER

D410332422 REACTANCIA DIMABLE-ROJO LACADO BRILLANTE
DIMMING BALLAST-RED BRILLIANT LACQUER

Reactancia dimable DALI / *DALI ballast*

Acabados: lacado brillante / *brilliant lacquer*

Material: Poliuretano / *Polyurethane*

Difusor cristal óptico mate / *Optical glass diffuser*

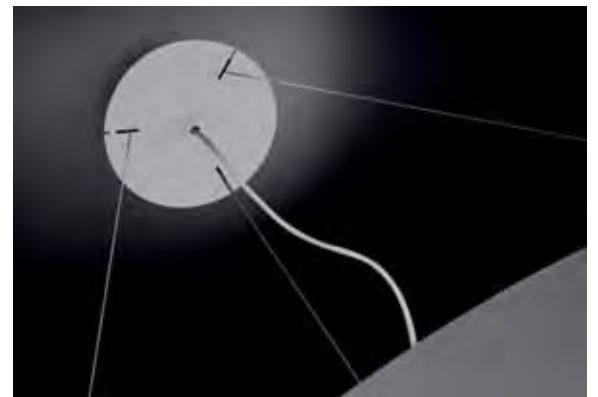

ACABADOS / FINISHING

LACADO ROJO
RED LACQUER

LACADO BLANCO
WHITE LACQUER

LACADO NEGRO
BLACK LACQUER







BIG FORMAT

Hotel Vincci Bit / Barcelona

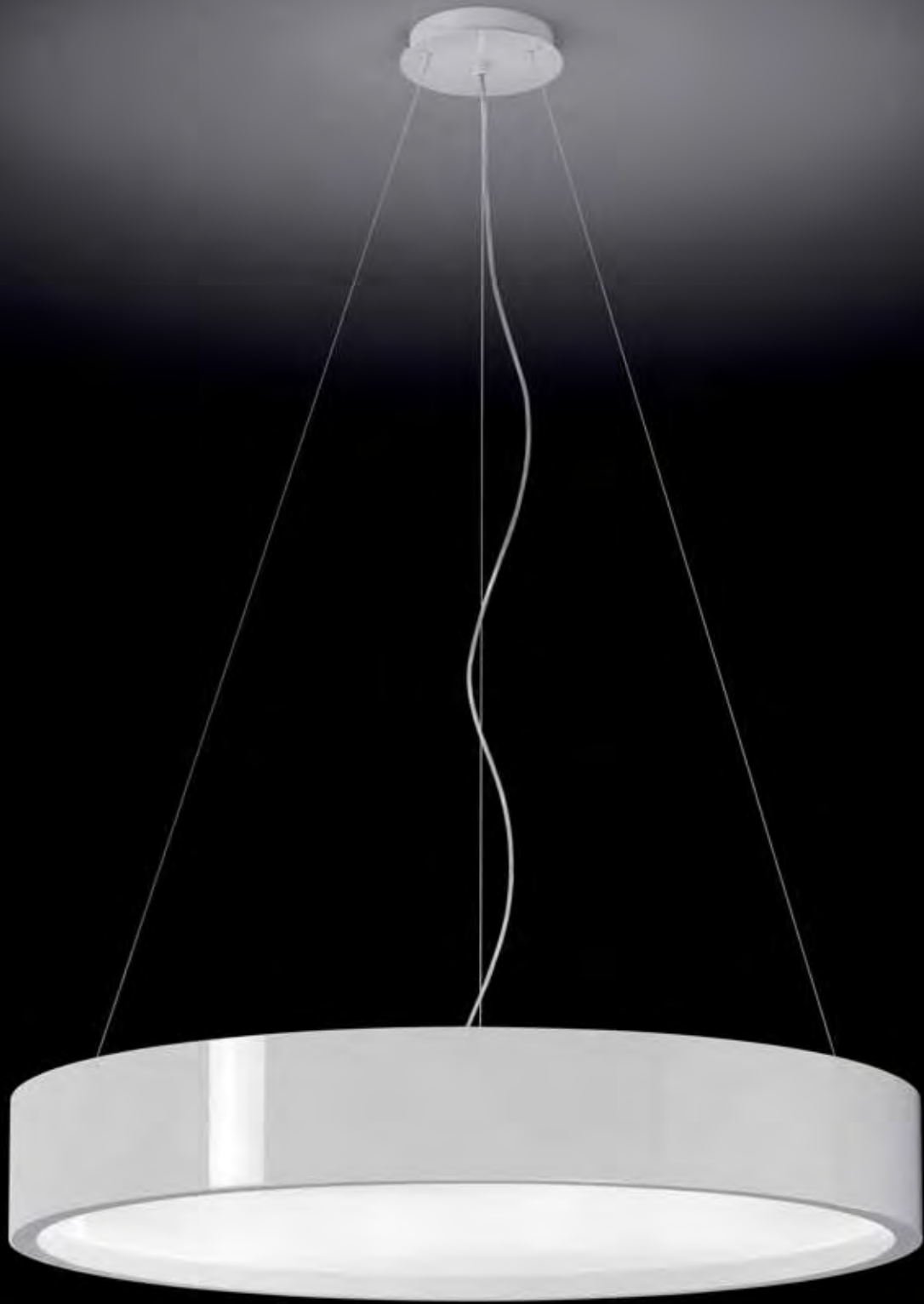

ELIPSE - 30

SUSPENSIÓN
PENDANT LAMP



2 x 22 W E-27

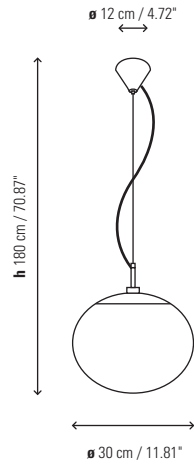

- 4032301 BOLA 30 - BLANCO / BALL 30 - WHITE
- 4032305 BOLA 30 - NÍQUEL / BALL 30 - NICKEL

Globo de polietileno de media densidad y protección UV/light
Polyethylene globe of medium density and UV/light protection.

ELIPSE - 50

SUSPENSIÓN
PENDANT LAMP



2 x 30 W E-27

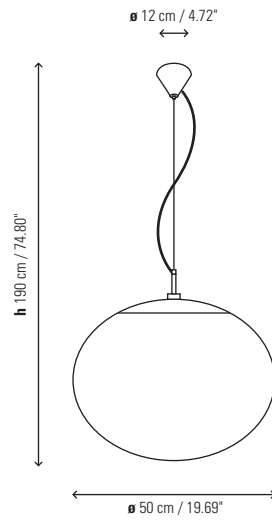

- 4132301 BOLA 50 - BLANCO / BALL 50 - WHITE
- 4132305 BOLA 50 - NÍQUEL / BALL 50 - NICKEL

Globo de polietileno de media densidad y protección UV/light
Polyethylene globe of medium density and UV/light protection.









GLO

SUSPENSIÓN
PENDANT LAMP



2 x 22 W E-27

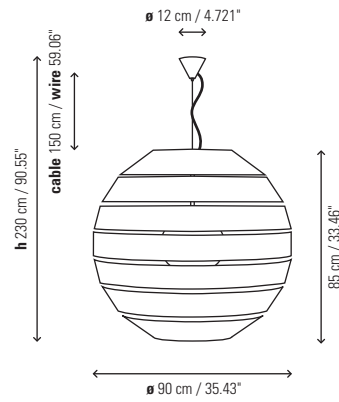

322P702 NÍQUEL-CINTA TRANSLÚCIDA BLANCA
NICKEL-WHITE TRANSLUCENT RIBBON

322P703 NÍQUEL-CINTA TRANSLÚCIDA CREMA
NICKEL-CREAM TRANSLUCENT RIBBON

322P704 NÍQUEL-CINTA TRANSLÚCIDA ROJA
NICKEL-RED TRANSLUCENT RIBBON

Altura regulable / Adjustable tensor wire
 Conexión transparente / Transparent wire
 La fuente de luz está protegida por un globo de polietileno
 Light source is protected by a polyethylene globe



ACABADOS / FINISHING





BIG FORMAT





HARDY

SUSPENSIÓN
PENDANT LAMP



1 x 6 W GU10 LED

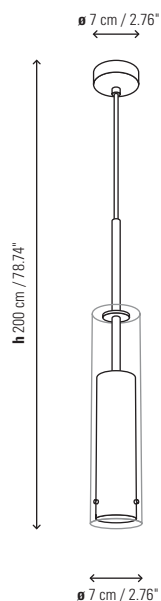

- 4131206 CRISTAL - CROMO / CHROME GLASS
- 4131221 CRISTAL - BLANCO / WHITE GLASS
- 4131299 CRISTAL - DORADO / GOLD GLASS

Bombilla led incluida / Led bulb included

Altura regulable / Adjustable wire

Material: Cristal borosilicato / Borosilicate glass

ACABADOS / FINISHING

CROMO BRILLANTE
BRILLIANT CHROME

BLANCO
WHITE

ORO
GOLD









Restaurant Pasarela / La Roca Village

INARI
SUSPENSIÓN
PENDANT LAMP

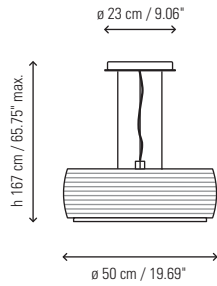

- 4120205 NÍQUEL-CRISTAL OPAL GRABADO
NICKEL-OPAL GLASS
- 4120206 CROMO-CRISTAL OPAL GRABADO
CHROME-OPAL GLASS

Debido a la naturaleza del cristal soplado, pueden aparecer pequeñas burbujas o variaciones que no se consideran defectos.
Due to the nature of the hand blown cristal, natural variations should be expected and will not be considered an imperfection.

FAMÍLIA / FAMILY

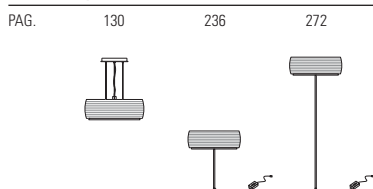

ACABADOS / FINISHING









LÁMPARA XVIII

SUSPENSIÓN
PENDANT LAMP



18 x 42 W Classic P ECO E-27

18 x 11 W E-27

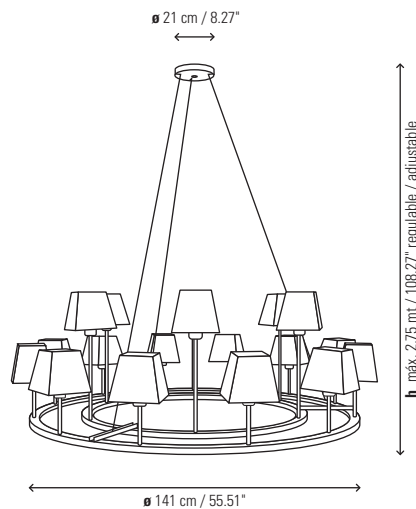

4610306 GRIS PLATA-CROMO / GREY SILVER-CHROME
4610304 MARRÓN GRAFITO-NÍQUEL / GRAPHITE BROWN-NICKEL

Lámpara con 2 encendidos
With 2 lighting-mood positions

Altura regulable
Adjustable height

Cable tensor con rótulas interiores regulables para un correcto y fácil posicionamiento de la luminaria

For easier installation, available with tensor wires including interior ball-and-socket joints

Conexión manguera algodón gris plata
Silver wire

Pantallas cuadradas 15 x 13 x 10 cm
Square lampshades 5.91" x 5.12" x 3.94"

P-640 COTONET BLANCO / WHITE COTTON
P-641 CINTA TRANSLÚCIDA BLANCA / WHITE TRANSLUCENT RIBBON
P-642 CINTA TRANSLÚCIDA CREMA / CREAM TRANSLUCENT RIBBON
P-643 CINTA TRANSLÚCIDA ROJA / RED TRANSLUCENT RIBBON

Pantallas cónicas 18 x 15 x 12 cm
Cone-shaped shades 7.09" x 5.91" x 4.72"

P-750 COTONET / COTTON
P-751 CINTA TRANSLÚCIDA BLANCA / WHITE TRANSLUCENT RIBBON
P-752 CINTA TRANSLÚCIDA CREMA / CREAM TRANSLUCENT RIBBON
P-753 CINTA TRANSLÚCIDA ROJA / RED TRANSLUCENT RIBBON



ACABADOS / FINISHING

MARRÓN GRAFITO
GRAPHITE BROWN

GRIS PLATA
GREY SILVER

CROMO BRILLANTE
BRILLIANT CHROME

NÍQUEL SATINADO
SATIN NICKEL

COTONET
COTTON

CINTA BLANCA
WHITE RIBBON

CINTA CREMA
CREAM RIBBON

CINTA ROJA
RED RIBBON









LUA - 1 LUZ

SUSPENSIÓN
PENDANT LAMP

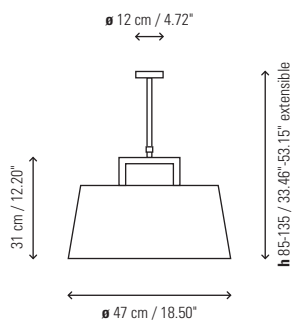

- 4122904 HIERRO NEGRO / *BLACK IRON*
- 4122905 NÍQUEL SATINADO / *SATIN NICKEL*
- 4122960 NÍQUEL PIEL OSCURA / *NICKEL DARK LEATHER*
- 4122961 NÍQUEL PIEL CUERO / *NICKEL CARAMEL LEATHER*

Pantalla 47 x 21 x 40 cm / *Lampshade 18.50" x 8.27" x 15.75"*

- P-160C COTONET / *COTTON*
- P-183C CINTA TRANSLÚCIDA CREMA / *CREAM TRANSLUCENT RIBBON*
- P-184C CINTA TRANSLÚCIDA BLANCA / *WHITE TRANSLUCENT RIBBON*

Pantalla incluye difusor superior / *The shade includes upper diffuser*

LUA - 2 LUCES

SUSPENSIÓN
PENDANT LAMP

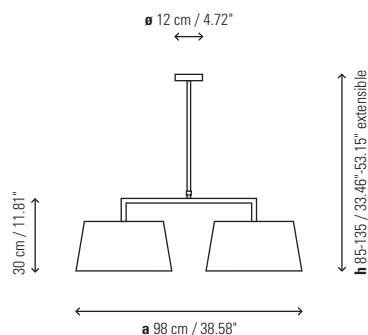

- 4222904 HIERRO NEGRO / *BLACK IRON*
- 4222905 NÍQUEL SATINADO / *SATIN NICKEL*
- 4222960 NÍQUEL PIEL OSCURA / *NICKEL DARK LEATHER*
- 4222961 NÍQUEL PIEL CUERO / *NICKEL CARAMEL LEATHER*

Pantalla 38 x 20 x 30 cm / *Lampshade 14.96" x 7.87" x 11.81"*

- P-163C COTONET / *COTTON*
- P-167C CINTA TRANSLÚCIDA CREMA / *CREAM TRANSLUCENT RIBBON*
- P-168C CINTA TRANSLÚCIDA BLANCA / *WHITE TRANSLUCENT RIBBON*

Pantalla incluye difusor superior / *The shade includes upper diffuser*

ACABADOS / FINISHING





MAR

SUSPENSIÓN
PENDANT LAMP



3 x 42 W Classic P ECO E-27

3 x 11 W E-27

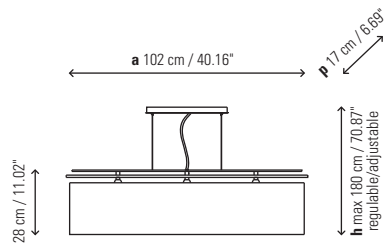

4324405 T NÍQUEL CABLE TRANSPARENTE / NICKEL TRANSPARENT WIRE

4324405 R NÍQUEL CABLE ROJO / NICKEL RED WIRE

4324460 PIEL OSCURA CABLE TRANSPARENTE
DARK LEATHER TRANSPARENT WIRE

4324461 PIEL CUERO CABLE TRANSPARENTE
CAMEL LEATHER TRANSPARENT WIRE

Pantalla rectangular plana 100 x 17 cm. Incluye difusor
Rectangular lampshade 39.37" x 6.69". Diffuser included

P-521 CINTA TRANSLÚCIDA CREMA / CREAM TRANSLUCENT RIBBON

P-522 CINTA TRANSLÚCIDA BLANCA / WHITE TRANSLUCENT RIBBON

P-523 CINTA TRANSLÚCIDA ROJA / RED TRANSLUCENT RIBBON

P-524 COTONET / COTTON

Incluye difusor PVC inferior / Diffuser PVC included



ACABADOS / FINISHING

NÍQUEL SATINADO
SATIN NICKEL

PIEL OSCURA
DARK LEATHER

PIEL CLARA
CAMEL LEATHER

COTONET
COTTON

CINTA CREMA
CREAM RIBBON

CINTA BLANCA
WHITE RIBBON

CINTA ROJA
RED RIBBON

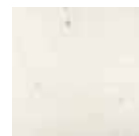
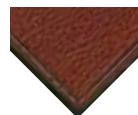
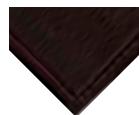



BISAZZA

MAXI - 01

SUSPENSIÓN
PENDANT LAMP



4 x 42 W Classic P ECO E-27

4 x 30 W E-27

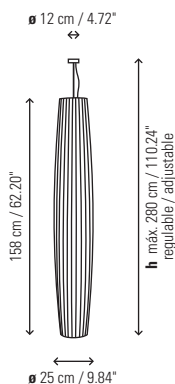

43195TOP INSTALACIÓN SUPERIOR / ELECTRICAL UPPER INSTALLATION
4319505 INSTALACIÓN INFERIOR / ELECTRICAL BOTTOM INSTALLATION

Pantalla 158 X 25 cm / Lampshade 62.20" X 9.84"

P-507T TOP CINTA CREMA / TOP CREAM RIBBON
P-508T TOP CINTA BLANCA / TOP WHITE RIBBON
P-507I INST. INF. CINTA CREMA / BOTTOM INST. CREAM RIBBON
P-508I INST. INF. CINTA BLANCA / BOTTOM INST. WHITE RIBBON

Altura regulable cable tensor con seguro / Adjustable tensor wire
Florón níquel (sólo para instalación superior)
Nickel canopy (only for upper installation)
Bombillas Eco Classic incluidas / Eco Classic bulbs included

Maxi 01 / Maxi 02 suspensión está disponible en dos versiones: con instalación superior y con instalación inferior.
Maxi 01 / Maxi 02 pendant lamp comes in two versions: with upper installation and with bottom installation.

MAXI - 02

SUSPENSIÓN
PENDANT LAMP



4 x 42 W Classic P ECO E-27

4 x 30 W E-27

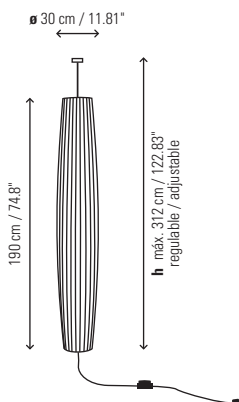

44195TOP INSTALACIÓN SUPERIOR / ELECTRICAL UPPER INSTALLATION
4419505 INSTALACIÓN INFERIOR / ELECTRICAL BOTTOM INSTALLATION

Pantalla 190 X 30 cm / Lampshade 74.8" X 11.81"

P-506T TOP CINTA CREMA / TOP CREAM RIBBON
P-509T TOP CINTA BLANCA / TOP WHITE RIBBON
P-506I INST. INF. CINTA CREMA / BOTTOM INST. CREAM RIBBON
P-509I INST. INF. CINTA BLANCA / BOTTOM INST. WHITE RIBBON

Altura regulable cable tensor con seguro / Adjustable tensor wire
Florón níquel (sólo para instalación superior)
Nickel canopy (only for upper installation)
Bombillas Eco Classic incluidas / Eco Classic bulbs included

Maxi 01 / Maxi 02 suspensión está disponible en dos versiones: con instalación superior y con instalación inferior.
Maxi 01 / Maxi 02 pendant lamp comes in two versions: with upper installation and with bottom installation.

MAXI - 03 / DIMABLE

SUSPENSIÓN
PENDANT LAMP



2 x 54 W T5

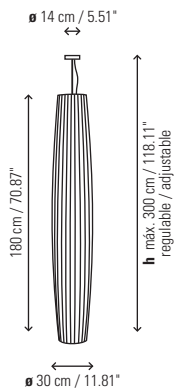

4303195TOP INSTALACIÓN SUPERIOR / ELECTRICAL UPPER INSTALLATION

Pantalla 180 X 30 cm / Lampshade 70.87" X 11.81"

P-754T TOP CINTA CREMA / TOP CREAM RIBBON
P-755T TOP CINTA BLANCA / TOP WHITE RIBBON

Altura regulable cable tensor con seguro / Adjustable tensor wire
Florón níquel / Nickel canopy
Inclusión de tubos fluorescentes ya instalados en el interior de la luminaria
Supply fluorescent tubes already installed inside the luminaire.

Reactancia dimable DALI / DALI ballast

FAMILIA / FAMILY

PAG. 32 32 32 142 142 142 274 274

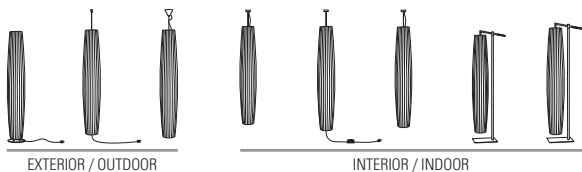

ACABADOS / FINISHING

NÍQUEL SATINADO SATIN NICKEL CINTA CREMA CREAM RIBBON CINTA BLANCA WHITE RIBBON









MEI - 38

SUSPENSIÓN
PENDANT LAMP



1 x 42 W Classic P ECO E-27

1 x 11 W E-27

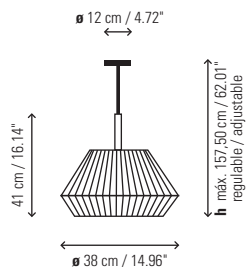

- 4219903 HIERRO MARRÓN / BROWN IRON
- 4219904 HIERRO NEGRO / BLACK IRON
- 4219905 NÍQUEL SATINADO / SATIN NICKEL

Pantalla 32 x 19 x 20 cm / Lampshade 12.60" x 7.48" x 7.87"

Incluye difusor PVC / Diffuser PVC included

Conexión transparente / Transparent connection

- P-495C CINTA TRANSLÚCIDA ROJA / RED TRANSLUCENT RIBBON
- P-504C CINTA TRANSLÚCIDA CREMA / CREAM TRANSLUCENT RIBBON
- P-505C CINTA TRANSLÚCIDA BLANCA / WHITE TRANSLUCENT RIBBON

MEI - 60

SUSPENSIÓN
PENDANT LAMP



1 x 70 W Classic A ECO E-27

1 x 18 W E-27

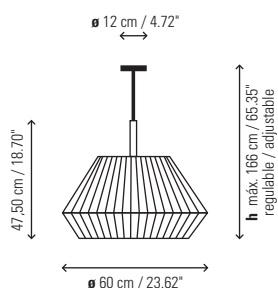

- 4119903 HIERRO MARRÓN / BROWN IRON
- 4119904 HIERRO NEGRO / BLACK IRON
- 4119905 NÍQUEL SATINADO / SATIN NICKEL

Pantalla 50 x 31 x 30 cm / Lampshade 19.69" x 12.20" x 11.81"

Incluye difusor PVC / Diffuser PVC included

Conexión transparente / Transparent connection

- P-496C CINTA TRANSLÚCIDA NEGRA / BLACK TRANSLUCENT RIBBON
- P-501C CINTA TRANSLÚCIDA ROJA / RED TRANSLUCENT RIBBON
- P-502C CINTA TRANSLÚCIDA CREMA / CREAM TRANSLUCENT RIBBON
- P-503C CINTA TRANSLÚCIDA BLANCA / WHITE TRANSLUCENT RIBBON

MEI - 90

SUSPENSIÓN
PENDANT LAMP



3 x 70 W Classic A ECO E-27

3 x 22 W E-27

BIG FORMAT

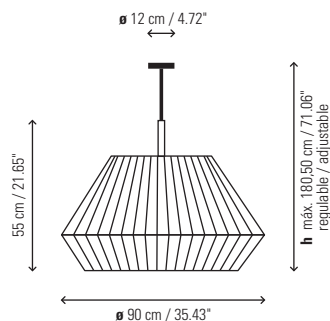

- 4419903 HIERRO MARRÓN / BROWN IRON
- 4419904 HIERRO NEGRO / BLACK IRON
- 4419905 NÍQUEL SATINADO / SATIN NICKEL

Pantalla 80 x 41,50 x 35 cm / Lampshade 31.50" x 16.34" x 13.78"

Incluye difusor PVC / Diffuser PVC included

Conexión transparente / Transparent connection

- P-490C CINTA TRANSLÚCIDA BLANCA / WHITE TRANSLUCENT RIBBON
- P-491C CINTA TRANSLÚCIDA CREMA / CREAM TRANSLUCENT RIBBON
- P-492C CINTA TRANSLÚCIDA ROJA / RED TRANSLUCENT RIBBON
- P-493C CINTA TRANSLÚCIDA NEGRA / BLACK TRANSLUCENT RIBBON

ACABADOS / FINISHING

HIERRO MARRÓN / BROWN IRON HIERRO NEGRO / BLACK IRON NÍQUEL SATINADO / SATIN NICKEL

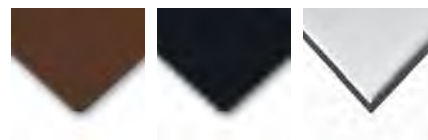

CINTA CREMA / CREAM RIBBON CINTA BLANCA / WHITE RIBBON CINTA ROJA / RED RIBBON CINTA NEGRA / BLACK RIBBON



FAMÍLIA / FAMILY

PAG. 146 146 146 150 150







Danone / Barcelona





MEI - 125

SUSPENSIÓN
PENDANT LAMP



5 x 70 W Classic A ECO E-27

5 x 22 W E-27

BIG FORMAT

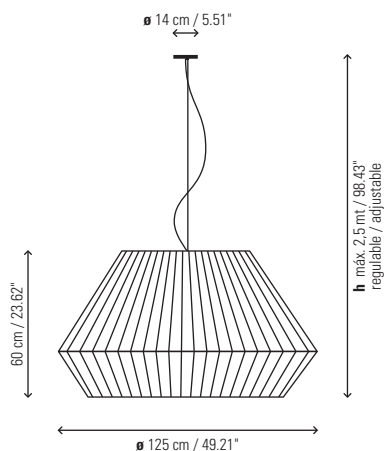

- 4719903 HIERRO MARRÓN / BROWN IRON
- 4719904 HIERRO NEGRO / BLACK IRON
- 4719905 NÍQUEL SATINADO / SATIN NICKEL

Pantalla 125 x 60 x 48 cm / Lampshade 49.21" x 23.62" x 18.90"

Incluye difusor PVC / Diffuser PVC included

Conexión transparente / Transparent connection

- P-720C CINTA TRANSLÚCIDA BLANCA / WHITE TRANSLUCENT RIBBON
- P-721C CINTA TRANSLÚCIDA CREMA / CREAM TRANSLUCENT RIBBON
- P-722C CINTA TRANSLÚCIDA ROJA / RED TRANSLUCENT RIBBON
- P-723C CINTA TRANSLÚCIDA NEGRA / BLACK TRANSLUCENT RIBBON

MEI - 150

SUSPENSIÓN
PENDANT LAMP



6 x 70 W Classic A ECO E-27

6 x 30 W E-27

BIG FORMAT

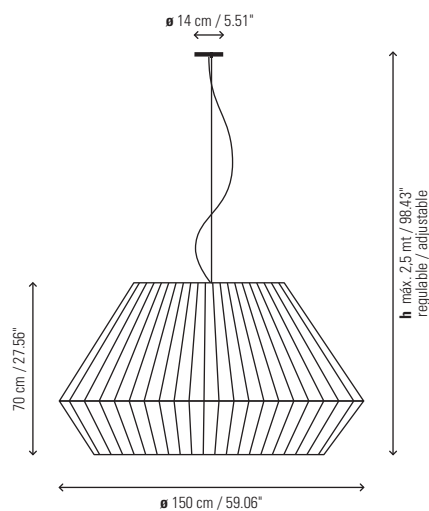

- 4619903 HIERRO MARRÓN / BROWN IRON
- 4619904 HIERRO NEGRO / BLACK IRON
- 4619905 NÍQUEL SATINADO / SATIN NICKEL

Pantalla 150 x 70 x 59 cm / Lampshade 59.06" x 27.56" x 23.23"

Incluye difusor PVC / Diffuser PVC included

Conexión transparente / Transparent connection

Portalámparas cerámicos / Porcelain lampholders

- P-590C CINTA TRANSLÚCIDA BLANCA / WHITE TRANSLUCENT RIBBON
- P-591C CINTA TRANSLÚCIDA CREMA / CREAM TRANSLUCENT RIBBON
- P-592C CINTA TRANSLÚCIDA ROJA / RED TRANSLUCENT RIBBON
- P-593C CINTA TRANSLÚCIDA NEGRA / BLACK TRANSLUCENT RIBBON

ACABADOS / FINISHING

HIERRO MARRÓN
BROWN IRON

HIERRO NEGRO
BLACK IRON

NÍQUEL SATINADO
SATIN NICKEL



FAMÍLIA / FAMILY

PAG. 146 146 146 150 150



CINTA CREMA
CREAM RIBBON

CINTA BLANCA
WHITE RIBBON

CINTA ROJA
RED RIBBON

CINTA NEGRA
BLACK RIBBON





MEI - 100

SUSPENSIÓN
PENDANT LAMP



3 x 42 W Classic P ECO E-27

3 x 11 W E-27
Duluxstar mini twist

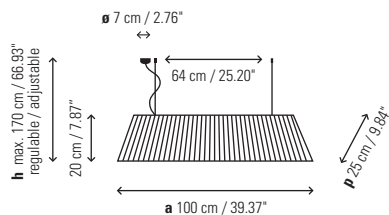

- 4319903 HIERRO MARRÓN / BROWN IRON
- 4319904 HIERRO NEGRO / BLACK IRON
- 4319905 NÍQUEL SATINADO / SATIN NICKEL

Pantalla rectangular 100 x 25 cm / Rectangular lampshade 39.37" x 9.84"
Incluye difusor PVC / Diffuser PVC included

- P-497C CINTA TRANSLÚCIDA CREMA / CREAM TRANSLUCENT RIBBON
- P-498C COTONET / COTTON
- P-499C LINO / LINEN
- P-584C CINTA TRANSLÚCIDA BLANCA / WHITE TRANSLUCENT RIBBON
- P-585C CINTA TRANSLÚCIDA ROJA / RED TRANSLUCENT RIBBON
- P-586C CINTA TRANSLÚCIDA NEGRA / BLACK TRANSLUCENT RIBBON

Altura regulable cable tensor con seguro / Adjustable tensor wire

MEI - 120

SUSPENSIÓN
PENDANT LAMP



5 x 42 W Classic P ECO E-27

5 x 11 W E-27
Duluxstar mini twist

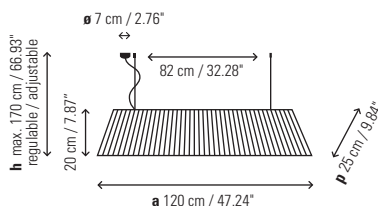

- 4519903 HIERRO MARRÓN / BROWN IRON
- 4519904 HIERRO NEGRO / BLACK IRON
- 4519905 NÍQUEL SATINADO / SATIN NICKEL

Pantalla rectangular 120 x 25 cm / Rectangular lampshade 47.24" x 9.84"
Incluye difusor PVC / Diffuser PVC included

- P-510C CINTA TRANSLÚCIDA CREMA / CREAM TRANSLUCENT RIBBON
- P-511C COTONET / COTTON
- P-512C LINO / LINEN
- P-514C CINTA TRANSLÚCIDA BLANCA / WHITE TRANSLUCENT RIBBON
- P-522C CINTA TRANSLÚCIDA ROJA / RED TRANSLUCENT RIBBON
- P-523C CINTA TRANSLÚCIDA NEGRA / BLACK TRANSLUCENT RIBBON

Altura regulable cable tensor con seguro / Adjustable tensor wire

MEI - 180

SUSPENSIÓN
PENDANT LAMP



6 x 42 W Classic P ECO E-27

6 x 11 W E-27
Duluxstar mini twist

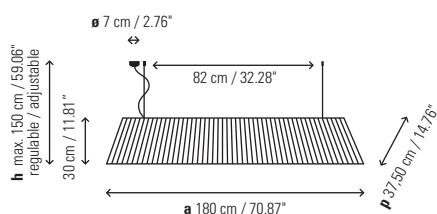

- 430319903 HIERRO MARRÓN / BROWN IRON
- 430319904 HIERRO NEGRO / BLACK IRON
- 430319905 NÍQUEL SATINADO / SATIN NICKEL

Pantalla rectangular 180 x 37,50 cm / Rectangular lampshade 70.87" x 14.76"
Incluye difusor PVC / Diffuser PVC included

- P-756C CINTA TRANSLÚCIDA CREMA / CREAM TRANSLUCENT RIBBON
- P-757C COTONET / COTTON
- P-758C LINO / LINEN
- P-759C CINTA TRANSLÚCIDA BLANCA / WHITE TRANSLUCENT RIBBON
- P-760C CINTA TRANSLÚCIDA ROJA / RED TRANSLUCENT RIBBON
- P-761C CINTA TRANSLÚCIDA NEGRA / BLACK TRANSLUCENT RIBBON

Altura regulable cable tensor con seguro / Adjustable tensor wire

BIG FORMAT

ACABADOS / FINISHING

HIERRO MARRÓN
BROWN IRON



HIERRO NEGRO
BLACK IRON



NÍQUEL SATINADO
SATIN NICKEL



LINO
LINEN

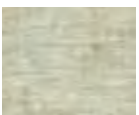

COTONET
COTTON



CINTA CREMA
CREAM RIBBON



CINTA BLANCA
WHITE RIBBON



CINTA ROJA
RED RIBBON



CINTA NEGRA
BLACK RIBBON









MEI OVAL

SUSPENSIÓN
PENDANT LAMP



3 x 42 W Classic P ECO E-27

3 x 11 W E-27
Duluxstar mini twist

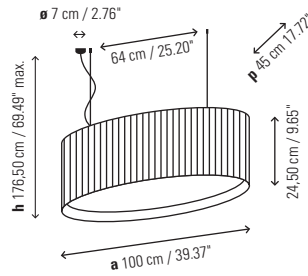

- 4319903 HIERRO MARRÓN / BROWN IRON
- 4319904 HIERRO NEGRO / BLACK IRON
- 4319905 NÍQUEL SATINADO / SATIN NICKEL

Pantalla oval 100 x 24,50 x 44 cm / Oval lampshade 39.37" x 9.65" x 17.32"

- P-545C CINTA TRANSLÚCIDA BLANCA / WHITE TRANSLUCENT RIBBON
- P-546C CINTA TRANSLÚCIDA CREMA / CREAM TRANSLUCENT RIBBON
- P-547C CINTA TRANSLÚCIDA NEGRA / BLACK TRANSLUCENT RIBBON
- P-548C COTONET BLANCO / WHITE COTTON

Incluye difusor PVC / Diffuser PVC included
Altura regulable cable tensor con seguro / Adjustable tensor wire



FAMÍLIA / FAMILY

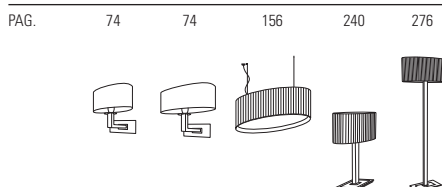

ACABADOS / FINISHING

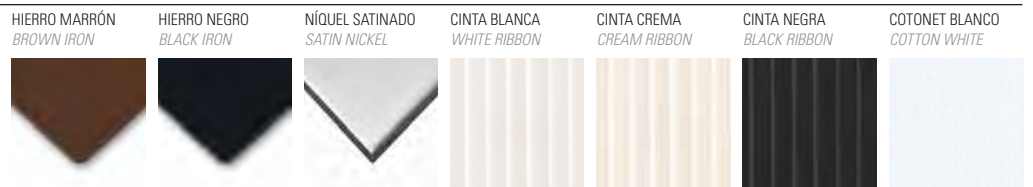



MOS - 01

SUSPENSIÓN
PENDANT LAMP



3 x 42 W Classic P ECO E-27

3 x 18 W E-27

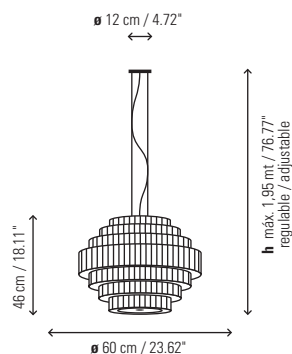

- 224P617 CINTA TRANSLÚCIDA BLANCA / WHITE TRANSLUCENT RIBBON
- 224P618 CINTA TRANSLÚCIDA CREMA / CREAM TRANSLUCENT RIBBON
- 224P619 CINTA TRANSLÚCIDA ROJA / RED TRANSLUCENT RIBBON

Incluye difusor inferior cristal opal blanco
Diffuser white opal glass included
Instalación níquel satinado / Satin nickel
Conexión transparente / Transparent connection
Altura regulable / Adjustable tensor wire
Cable tensor + seguro / Safety tensor wire

MOS - 02

SUSPENSIÓN
PENDANT LAMP



5 x 42 W Classic P ECO E-27

5 x 30 W E-27

OPCIONAL / OPTIONAL
Versión Led disponible / Consultar
Led source available / Consult

Led: 65 W
Lumens: 4.750 lm
Grados Kelvin: 2.600°
Degrees Kelvin: 2.600°

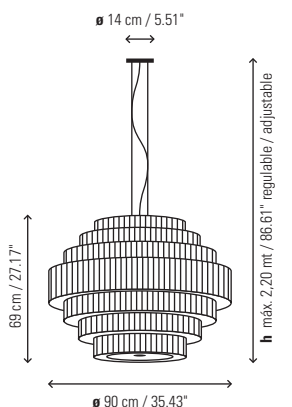

- 224P622 CINTA TRANSLÚCIDA BLANCA / WHITE TRANSLUCENT RIBBON
- 224P623 CINTA TRANSLÚCIDA CREMA / CREAM TRANSLUCENT RIBBON
- 224P624 CINTA TRANSLÚCIDA ROJA / RED TRANSLUCENT RIBBON

Incluye difusor inferior cristal opal blanco
Diffuser white opal glass included
Instalación níquel satinado / Satin nickel
Conexión transparente / Transparent connection
Altura regulable / Adjustable tensor wire
Cable tensor + seguro / Safety tensor wire

MOS - 03

SUSPENSIÓN
PENDANT LAMP



6 x 70 W Classic A ECO E-27

6 x 30 W E-27

MOS - 03 LED / DIMABLE

OPCIONAL / OPTIONAL
Versión Led disponible / Consultar
Led source available / Consult

Led: 80 W
Lumens: 5.830 lm
Grados Kelvin: 2600°
Degrees Kelvin: 2600°

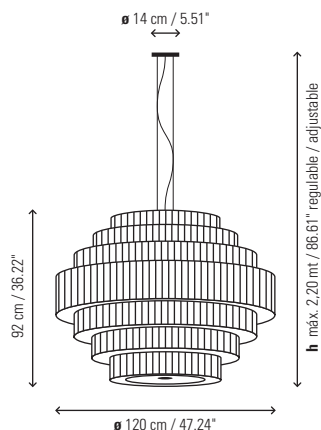

- 224P621 CINTA TRANSLÚCIDA BLANCA / WHITE TRANSLUCENT RIBBON
- 224P625 CINTA TRANSLÚCIDA CREMA / CREAM TRANSLUCENT RIBBON
- 224P626 CINTA TRANSLÚCIDA ROJA / RED TRANSLUCENT RIBBON

ACABADOS / FINISHING

CINTA CREMA
CREAM RIBBON

CINTA BLANCA
WHITE RIBBON

CINTA ROJA
RED RIBBON







BIG FORMAT

Poliform / Italy



BIG FORMAT

Hostal Empúries / L'Escala







OLIVER

SUSPENSIÓN
PENDANT LAMP



1 x 11 W Osram mini GLOBE E-27

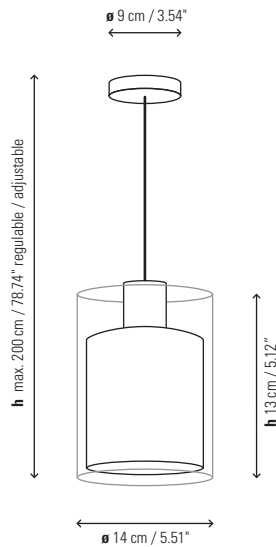

4131306 CROMO / CHROME

Pantalla 19 x 14 cm / Lampshade 7.48" x 5.51"

- P-734C CINTA TRANSLÚCIDA BLANCA / WHITE TRANSLUCENT RIBBON
- P-735C CINTA TRANSLÚCIDA CREMA / CREAM TRANSLUCENT RIBBON
- P-736C CINTA TRANSLÚCIDA ROJA / RED TRANSLUCENT RIBBON
- P-737C COTONET BLANCO / WHITE COTTON
- P-738C COTONET NEGRO / BLACK COTTON
- P-739C BLANCO INTERIOR NARANJA / WHITE-ORANGE INNER
- P-740C NEGRO INTERIOR NARANJA / BLACK-ORANGE INNER

Bombilla incluida / Bulb included

Material: Cristal borosilicato / Borosilicate glass

Conexión transparente / Transparent connection

Altura regulable / Adjustable wire



FAMÍLIA / FAMILY

PAG. 164 206

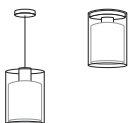

ACABADOS / FINISHING

CROMO BRILLANTE / BRILLIANT CHROME CINTA BLANCA / WHITE RIBBON CINTA CREMA / CREAM RIBBON CINTA ROJA / RED RIBBON COTONET BLANCO / COTTON WHITE COTONET NEGRO / BLACK COTTON COTONET BLANCO / COTTON WHITE COTONET NEGRO / BLACK COTTON







consell farmacèutic

ESPECIALITATS / HÒMEOPATIA / PRODUCTES NATURALS





ROLANDA - S

SUSPENSIÓN
PENDANT LAMP



1 x 150 W E-27 HALÓGENA

1 x 30 W E-27

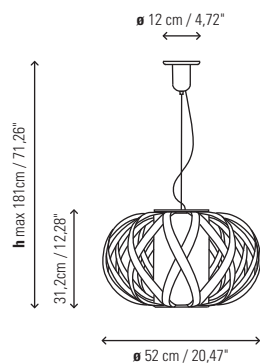

- 4122506 CROMO / CHROME
- 4122511 BLANCO-CROMO / WHITE-CHROME
- 4122505 NÍQUEL-CROMO / NICKEL-CHROME
- 4122509 ORO SATIN-ORO BRILLANTE / SATIN GOLD-BRILLIANT GOLD

Material: fleje acero inoxidable calibrado
Material: calibrated stainless steel strips

Difusor de cristal satinado / Satin glass diffuser
Altura regulable / Adjustable height

ROLANDITA - S

SUSPENSIÓN
PENDANT LAMP



1 x 150 W E-27 HALÓGENA

1 x 30 W E-27

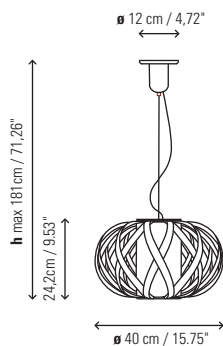

- 4022506 CROMO / CHROME
- 4022511 BLANCO-CROMO / WHITE-CHROME
- 4022505 NÍQUEL-CROMO / NICKEL-CHROME
- 4022509 ORO SATIN-ORO BRILLANTE / SATIN GOLD-BRILLIANT GOLD

Material: fleje acero inoxidable calibrado
Material: calibrated stainless steel strips

Difusor de cristal satinado / Satin glass diffuser
Altura regulable / Adjustable height



FAMÍLIA / FAMILY

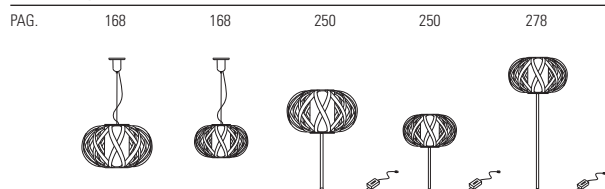

ACABADOS / FINISHING

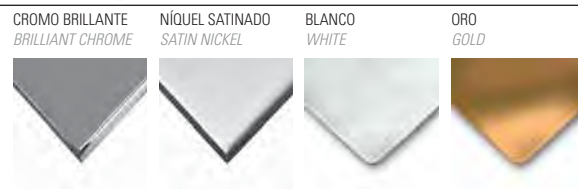







SIAM - 4 LUCES

SUSPENSIÓN
PENDANT LAMP

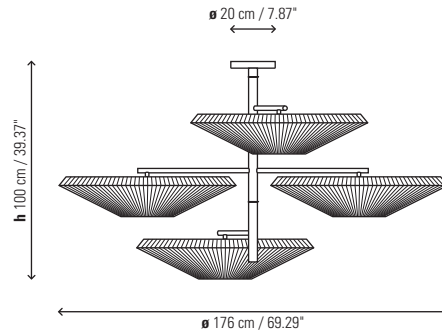

4432005 NÍQUEL SATINADO / SATIN NICKEL
4432001 BLANCO 9010 CRUDO / WHITE 9010

Pantalla / Lampshade: 80x18 cm (x4 UNIDADES / UNITS)

P-686C CINTA TRANSLÚCIDA BLANCA / WHITE TRANSLUCENT RIBBON
P-687C CINTA TRANSLÚCIDA CREMA / CREAM TRANSLUCENT RIBBON
P-688C CINTA TRANSLÚCIDA ROJA / RED TRANSLUCENT RIBBON

Difusor de metacrilato / Methacrylate diffuser

Ajustar brazos horizontales en la posición deseada y bloquear la estructura para fijar brazos por motivos de seguridad.

Place horizontal arms on the desired position and block structure to fix arms for safety reasons.

SIAM - 6 LUCES

SUSPENSIÓN
PENDANT LAMP

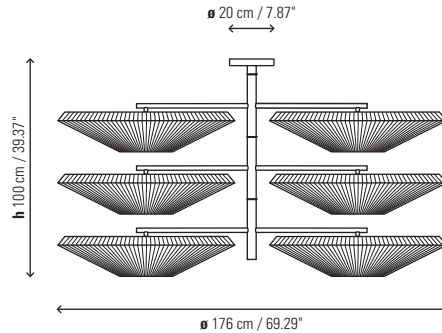

4632005 NÍQUEL SATINADO / SATIN NICKEL
4632001 BLANCO 9010 CRUDO / WHITE 9010

Pantalla / Lampshade: 80x18 cm (x6 UNIDADES / UNITS)

P-686C CINTA TRANSLÚCIDA BLANCA / WHITE TRANSLUCENT RIBBON
P-687C CINTA TRANSLÚCIDA CREMA / CREAM TRANSLUCENT RIBBON
P-688C CINTA TRANSLÚCIDA ROJA / RED TRANSLUCENT RIBBON

Difusor de metacrilato / Methacrylate diffuser

Ajustar brazos horizontales en la posición deseada y bloquear la estructura para fijar brazos por motivos de seguridad.

Place horizontal arms on the desired position and block structure to fix arms for safety reasons.

FAMÍLIA / FAMILY

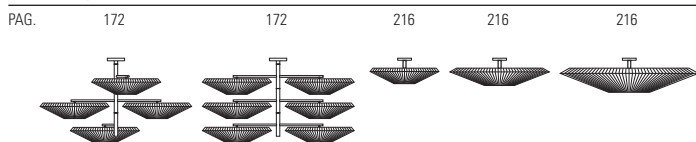

ACABADOS / FINISHING









SILANTRA - 07

SUSPENSIÓN
PENDANT LAMP



2 x 54 W T5 Fluorescente

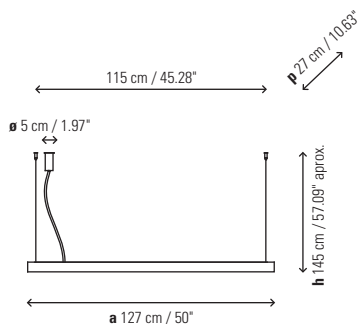

- 7245537 REACTANCIA ELECTRÓNICA / CINTA TRANSLÚCIDA CREMA
ELECTRONIC BALLAST / CREAM TRANSLUCENT RIBBON
- 7245538 REACTANCIA ELECTRÓNICA / CINTA TRANSLÚCIDA BLANCA
ELECTRONIC BALLAST / WHITE TRANSLUCENT RIBBON
- D7245537 REACTANCIA DIMABLE / CINTA TRANSLÚCIDA CREMA
DIMMING BALLAST / CREAM TRANSLUCENT RIBBON
- D7245538 REACTANCIA DIMABLE / CINTA TRANSLÚCIDA BLANCA
DIMMING BALLAST / WHITE TRANSLUCENT RIBBON

Aluminio pulido / *Polished aluminium*
Pantalla 67 x 67 cm / *Lampshade 26.38" x 26.38"*

Fotometría disponible / *Photometry available*

SISTEMA DALI / DALI SYSTEM:

Interfaz digital para el control de componentes electrónicos regulables.
Digital interface to control electronical dimming components.

SISTEMA PUSH-SISTEMA DIGITAL REGULADOR

PUSH SYSTEM-DIGITAL DIMMER SYSTEM:
Interfaz bipolar de las reactancias electrónicas para variar la intensidad luminosa de las lámparas mediante pulsadores.
Bipolar interface to electronical ballasts regulating luminous intensity through push buttons.

FAMÍLIA / FAMILY

PAG. 84 84 84 86 86 86 176

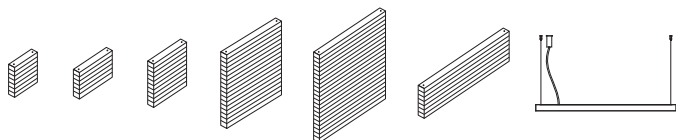

ACABADOS / FINISHING

ALUMINIO PULIDO / *POLISHED ALUMINIUM* CINTA CREMA / *CREAM RIBBON* CINTA BLANCA / *WHITE RIBBON*









TAU - 1 LUZ

SUSPENSIÓN
PENDANT LAMP



3 x 42 W Classic P ECO E-27

3 x 11 W E-27

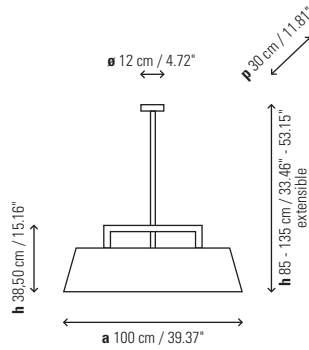

- 4323905 NÍQUEL SATINADO / SATIN NICKEL
- 4323960 NÍQUEL PIEL OSCURA / NICKEL DARK LEATHER
- 4323961 NÍQUEL PIEL CUERO / NICKEL CARAMEL LEATHER

Pantalla rectangular 100 x 30 x 80,50 cm
Rectangular lampshade 39.37" x 11.81" x 31.69"

Con difusor PVC inferior / With lower PVC diffuser

- P-482C LINO / LINEN
- P-483C COTONET / COTTON
- P-683 CINTA TRANSLÚCIDA BLANCA / WHITE TRANSLUCENT RIBBON
- P-684 CINTA TRANSLÚCIDA CREMA / CREAM TRANSLUCENT RIBBON

FAMÍLIA / FAMILY

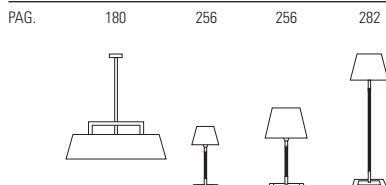

ACABADOS / FINISHING





TEKNO - LP1

SUSPENSIÓN
PENDANT LAMP



2 x 39 W T5 Fluorescente
Reactancia electrónica

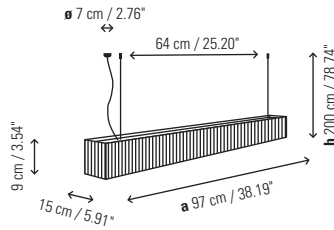

- 4218801 CINTA TRANSLÚCIDA BLANCA / WHITE TRANSLUCENT RIBBON
- 4218802 CINTA TRANSLÚCIDA CREMA / CREAM TRANSLUCENT RIBBON
- 4218803 COTONET BLANCO / WHITE COTTON
- 4218804 CINTA TRANSLÚCIDA ROJA / RED TRANSLUCENT RIBBON
- 4218805 CINTA TRANSLÚCIDA NEGRA / BLACK TRANSLUCENT RIBBON

Debido a la naturaleza de la cinta translúcida, las pantallas de cinta clara reflejan ligeramente los radios del armazón de la pantalla.
Due to translucent ribbon's nature, light colour shade may reflect the inner structure.

Difusor cristal óptico mate / *Optical glass diffuser*

Opción dimable: consultar.
Dimming optional ballast: to be consulted.

 Fotometría disponible / *Photometry available*

TEKNO - LP2

SUSPENSIÓN
PENDANT LAMP



2 x 54 W T5 Fluorescente
Reactancia electrónica

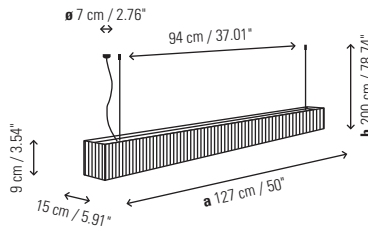

- 4318801 CINTA TRANSLÚCIDA BLANCA / WHITE TRANSLUCENT RIBBON
- 4318802 CINTA TRANSLÚCIDA CREMA / CREAM TRANSLUCENT RIBBON
- 4318803 COTONET BLANCO / WHITE COTTON
- 4318804 CINTA TRANSLÚCIDA ROJA / RED TRANSLUCENT RIBBON
- 4318805 CINTA TRANSLÚCIDA NEGRA / BLACK TRANSLUCENT RIBBON

Debido a la naturaleza de la cinta translúcida, las pantallas de cinta clara reflejan ligeramente los radios del armazón de la pantalla.
Due to translucent ribbon's nature, light colour shade may reflect the inner structure.

Difusor cristal óptico mate / *Optical glass diffuser*

Opción dimable: consultar.
Dimming optional ballast: to be consulted.

 Fotometría disponible / *Photometry available*



ACABADOS / FINISHING





TEKNO - C

SUSPENSIÓN
PENDANT LAMP



2 x 70 W Classic A ECO E-27

2 x 18 W E-27

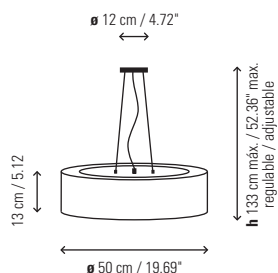

- 4118860 NÍQUEL PIEL OSCURA / *NICKEL DARK LEATHER*
- 4118861 NÍQUEL PIEL CUERO / *NICKEL CAMEL LEATHER*

Altura regulable cable tensor con seguro / *Adjustable tensor wire*
Conexión transparente / *Transparent connection*

Difusor cristal óptico mate / *Optical glass diffuser*

TEKNO - CP

SUSPENSIÓN
PENDANT LAMP



2 x 70 W Classic A ECO E-27

2 x 18 W E-27

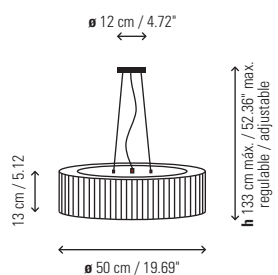

- 4118856 NÍQUEL COTONET BLANCO / *NICKEL WHITE COTTON*
- 4118857 NÍQUEL CINTA TRANSLÚCIDA BLANCA / *NICKEL WHITE TRANSLUCENT RIBBON*

- 4118858 NÍQUEL CINTA TRANSLÚCIDA CREMA / *NICKEL CREAM TRANSLUCENT RIBBON*

- 4118859 NÍQUEL CINTA TRANSLÚCIDA ROJA / *NICKEL RED TRANSLUCENT RIBBON*

Altura regulable cable tensor con seguro / *Adjustable tensor wire*
Conexión cable rojo / *Red wire connection*

 Fotometría disponible / *Photometry available*

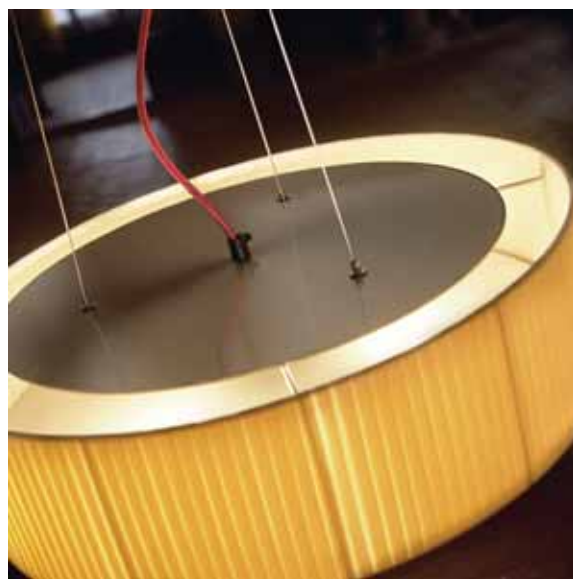

ACABADOS / FINISHING

NÍQUEL SATINADO
SATIN NICKEL

PIEL OSCURA
DARK LEATHER

PIEL CLARA
CAMEL LEATHER

COTONET BLANCO
COTTON WHITE

CINTA BLANCA
WHITE RIBBON

CINTA CREMA
CREAM RIBBON

CINTA ROJA
RED RIBBON

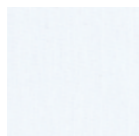
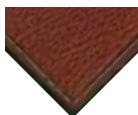
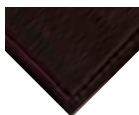



TWINS - 01

SUSPENSIÓN
PENDANT LAMP



1 x 7 W Master LEDbulb Designer E-27

BOMBILLA OPCIONAL / OPTIONAL BULB



1 x 60 W Globo ø80 E-27

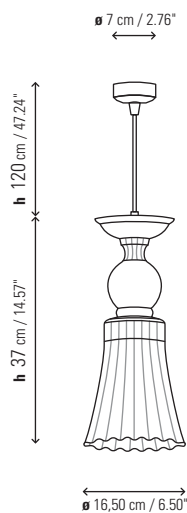

410131106 CRISTAL SOPLADO - CABLE TRANSPARENTE
BLOWN GLASS TRANSPARENT WIRE

410131122 CRISTAL SOPLADO - CABLE ROJO
BLOWN GLASS RED WIRE

Bombilla led incluida / Led bulb included

TWINS - 02

SUSPENSIÓN
PENDANT LAMP



1 x 7 W Master LEDbulb Designer E-27

BOMBILLA OPCIONAL / OPTIONAL BULB



1 x 60 W Globo ø80 E-27

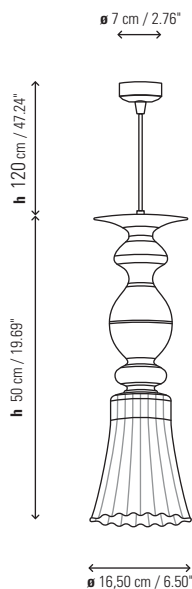

410231106 CRISTAL SOPLADO - CABLE TRANSPARENTE
BLOWN GLASS TRANSPARENT WIRE

410231122 CRISTAL SOPLADO - CABLE ROJO
BLOWN GLASS RED WIRE

Bombilla led incluida / Led bulb included

Material: Cristal soplado / Blown glass

Altura regulable / Adjustable wire

Debido a la naturaleza del cristal soplado, pueden aparecer pequeñas burbujas o variaciones que no se consideran defectos.
Due to the nature of the hand blown cristal, natural variations should be expected and will not be considered an imperfection.

ACABADOS / FINISHING

CROMO BRILLANTE
BRILLIANT CHROME

CROMO ROJO
RED CHROME

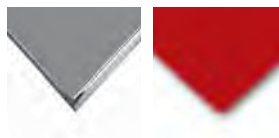







URBAN - 01

SUSPENSIÓN
PENDANT LAMP



2 x 42 W Classic P ECO E-27

2 x 22 W E-27

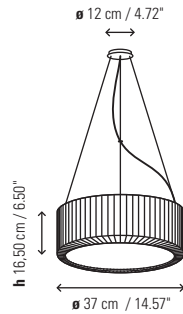

- 410132506 B CROMO-CINTA TRANSLÚCIDA BLANCA
CHROME-WHITE TRANSLUCENT RIBBON
- 410132506 C CROMO-CINTA TRANSLÚCIDA CREMA
CHROME-CREAM TRANSLUCENT RIBBON
- 410132506 R CROMO-CINTA TRANSLÚCIDA ROJA
CHROME-RED TRANSLUCENT RIBBON

Difusor superior cristal / Upper diffuser glass
Difusor inferior cristal + aro / Lower diffuser glass + ring

URBAN - 02

PLAFÓN
CEILING



4 x 42 W Classic P ECO E-27

4 x 22 W E-27

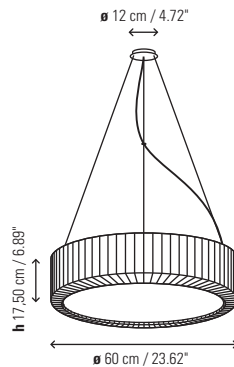

- 410232506 B CROMO-CINTA TRANSLÚCIDA BLANCA
CHROME-WHITE TRANSLUCENT RIBBON
- 410232506 C CROMO-CINTA TRANSLÚCIDA CREMA
CHROME-CREAM TRANSLUCENT RIBBON
- 410232506 R CROMO-CINTA TRANSLÚCIDA ROJA
CHROME-RED TRANSLUCENT RIBBON

URBAN - 02

PLAFÓN
CEILING



1 x 40 W T5 Circular

+
1 x 60 W T5 Circular

- D410232506 B REACTANCIA DIMABLE/CROMO-CINTA TRANSLÚCIDA BLANCA
DIMMING BALLAST/CHROME-WHITE TRANSLUCENT RIBBON
- D410232506 C REACTANCIA DIMABLE/CROMO-CINTA TRANSLÚCIDA CREMA
DIMMING BALLAST/CHROME-CREAM TRANSLUCENT RIBBON
- D410232506 R REACTANCIA DIMABLE/CROMO-CINTA TRANSLÚCIDA ROJA
DIMMING BALLAST/CHROME-RED TRANSLUCENT RIBBON

Difusor superior cristal / Upper diffuser glass
Difusor inferior cristal + aro / Lower diffuser glass + ring

Reactancia dimable DALI / DALI ballast

URBAN - 03

PLAFÓN
CEILING

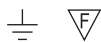

6 x 36 W 2G11

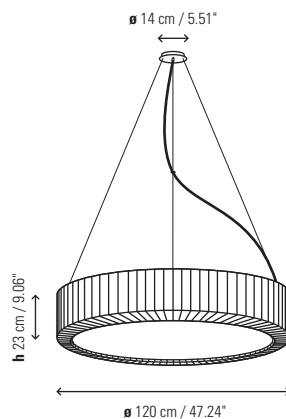

- 410332506 B CROMO-CINTA TRANSLÚCIDA BLANCA
CHROME-WHITE TRANSLUCENT RIBBON
- 410332506 C CROMO-CINTA TRANSLÚCIDA CREMA
CHROME-CREAM TRANSLUCENT RIBBON
- 410332506 R CROMO-CINTA TRANSLÚCIDA ROJA
CHROME-RED TRANSLUCENT RIBBON

- D410332506 B REACTANCIA DIMABLE/CROMO-CINTA TRANSLÚCIDA BLANCA
DIMMING BALLAST/CHROME-WHITE TRANSLUCENT RIBBON
- D410332506 C REACTANCIA DIMABLE/CROMO-CINTA TRANSLÚCIDA CREMA
DIMMING BALLAST/CHROME-CREAM TRANSLUCENT RIBBON
- D410332506 R REACTANCIA DIMABLE/CROMO-CINTA TRANSLÚCIDA ROJA
DIMMING BALLAST/CHROME-RED TRANSLUCENT RIBBON

Difusor metacrilato / Methacrylate diffuser
Difusor inferior metacrilato + aro / Lower diffuser methacrylate + ring

Reactancia dimable DALI / DALI ballast

FAMILIA / FAMILY

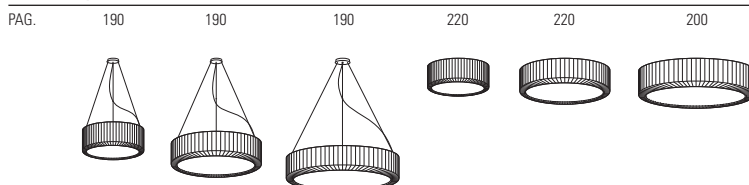

ACABADOS / FINISHING

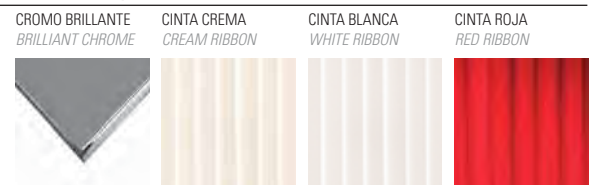







PLAFÓN *CEILING LAMP*



CALA

PLAFÓN
CEILING



4 x 22 W E-27

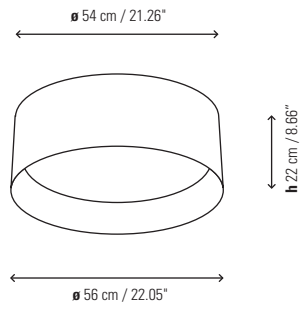

- 5132601 BLANCO LACADO BRILLANTE / *WHITE BRILLIANT LACQUER*
- 5132623 NEGRO LACADO BRILLANTE / *BLACK BRILLIANT LACQUER*
- 5132622 ROJO LACADO BRILLANTE / *RED BRILLIANT LACQUER*

Acabados: lacado brillante
Finishing: brilliant lacquer

Material: Poliuretano / *Polyurethane*

 Fotometría disponible / *Photometry available*



FAMÍLIA / FAMILY

PAG. 104 196

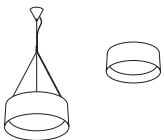

ACABADOS / FINISHING

LACADO ROJO / *RED LACQUER* LACADO BLANCO / *WHITE LACQUER* LACADO NEGRO / *BLACK LACQUER*









ELEA - 02

PLAFÓN
CEILING



4 x 22 W E-27

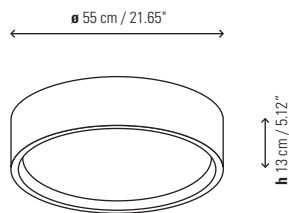

- 510232401 BLANCO LACADO BRILLANTE / *WHITE BRILLIANT LACQUER*
- 510232423 NEGRO LACADO BRILLANTE / *BLACK BRILLIANT LACQUER*
- 510232422 ROJO LACADO BRILLANTE / *RED BRILLIANT LACQUER*

Acabados: lacado brillante
Finishing: brilliant lacquer

Material: Poliuretano / *Polyurethane*

Difusor cristal óptico mate / *Optical glass diffuser*

ELEA - 03 / DIMABLE

PLAFÓN
CEILING



4 x 55 W 2G11

BIG FORMAT

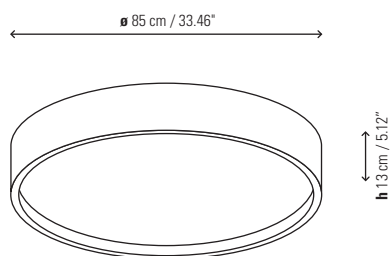

- 510332401 BLANCO LACADO BRILLANTE / *WHITE BRILLIANT LACQUER*
- 510332423 NEGRO LACADO BRILLANTE / *BLACK BRILLIANT LACQUER*
- 510332422 ROJO LACADO BRILLANTE / *RED BRILLIANT LACQUER*

D510332401 REACTANCIA DIMABLE-BLANCO LACADO BRILLANTE
DIMMING BALLAST-WHITE BRILLIANT LACQUER

D510332423 REACTANCIA DIMABLE-NEGRO LACADO BRILLANTE
DIMMING BALLAST-BLACK BRILLIANT LACQUER

D510332422 REACTANCIA DIMABLE-ROJO LACADO BRILLANTE
DIMMING BALLAST-RED BRILLIANT LACQUER

Acabados: lacado brillante
Finishing: brilliant lacquer

Material: Poliuretano / *Polyurethane*

Difusor cristal óptico mate / *Optical glass diffuser*

Reactancia dimable DALI / *DALI ballast*

ACABADOS / FINISHING

LACADO ROJO
RED LACQUER

LACADO BLANCO
WHITE LACQUER

LACADO NEGRO
BLACK LACQUER









KUADRAT - F

PLAFÓN
CEILING



1 x 40 W T5 Circular

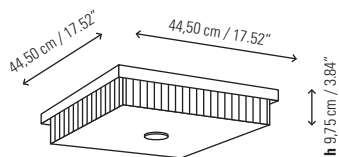

- 5015105F NÍQUEL SATINADO / SATIN NICKEL
- 5015106F CROMO BRILLANTE / BRILLIANT CHROME
- 5015108F GRIS GRAFITO / GREY GRAPHITE

Interior pantalla cotonet en poliéster / Inner cotton shade in polyester

- P-628 COTONET BLANCO / WHITE COTTON
- P-629 CINTA TRANSLÚCIDA BLANCA / WHITE TRANSLUCENT RIBBON
- P-630 CINTA TRANSLÚCIDA CREMA / CREAM TRANSLUCENT RIBBON

Difusor: cristal óptico mate / Diffuser: optical matte glass diffuser

KUADRAT - I

PLAFÓN
CEILING



4 x 42 W Classic P ECO E-14

4 x 11 W E-14

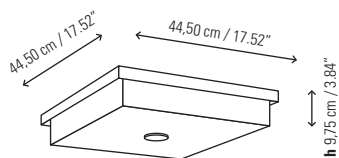

- 5015105I NÍQUEL SATINADO / SATIN NICKEL
- 5015106I CROMO BRILLANTE / BRILLIANT CHROME
- 5015108I GRIS GRAFITO / GREY GRAPHITE

Interior pantalla cotonet en poliéster / Inner cotton shade in polyester

- P-628 COTONET BLANCO / WHITE COTTON
- P-629 CINTA TRANSLÚCIDA BLANCA / WHITE TRANSLUCENT RIBBON
- P-630 CINTA TRANSLÚCIDA CREMA / CREAM TRANSLUCENT RIBBON

Difusor: cristal óptico mate / Diffuser: optical matte glass diffuser

ACABADOS / FINISHING

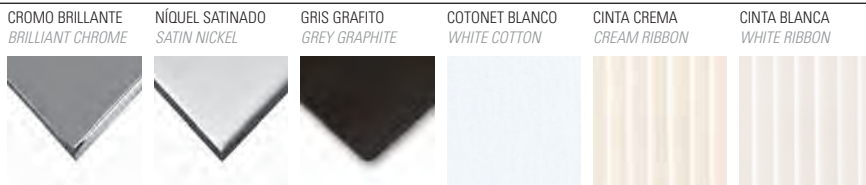

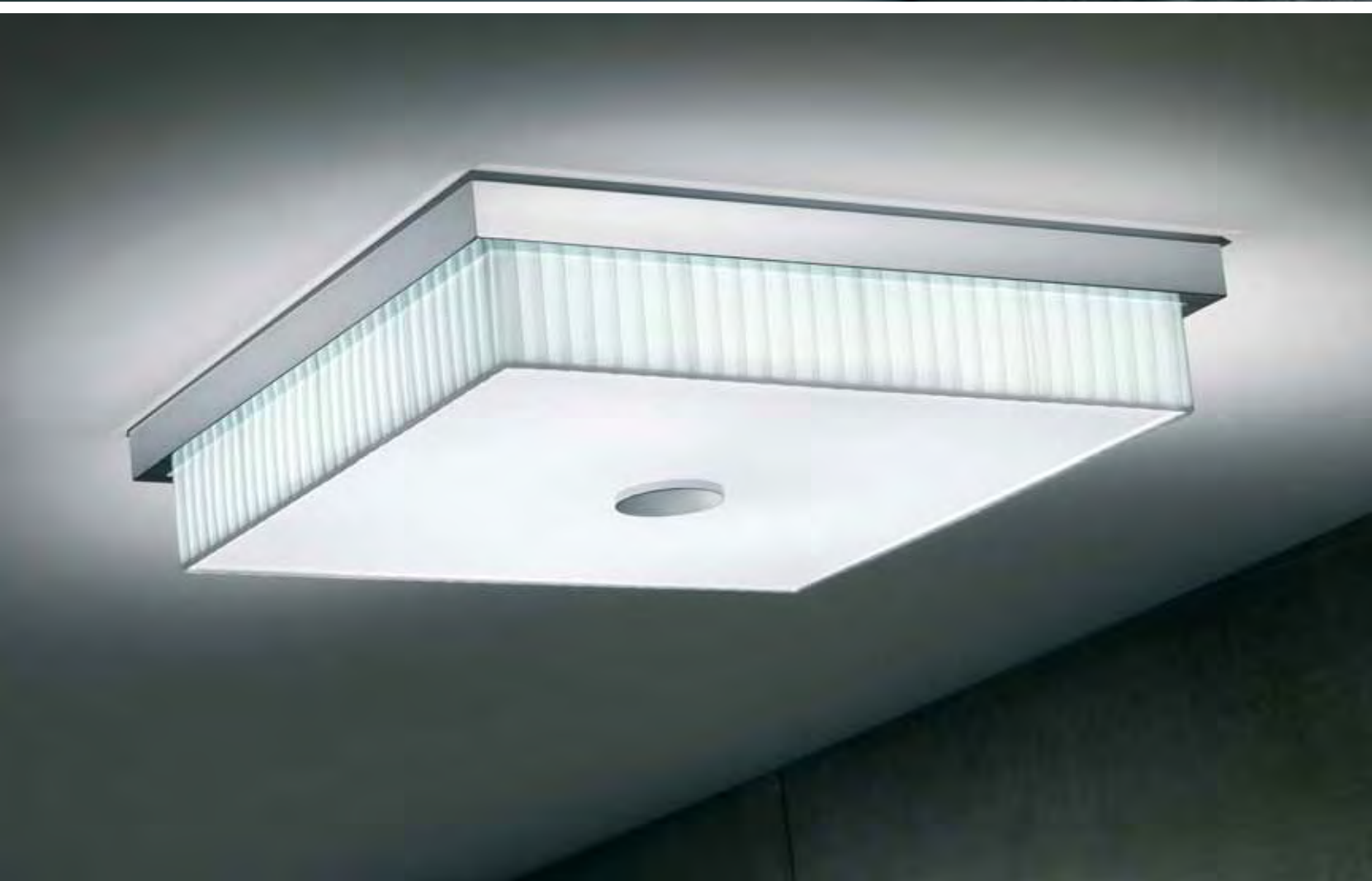

OLIVER

PLAFÓN
CEILING



1 x 11 W Osram mini GLOBE E-27

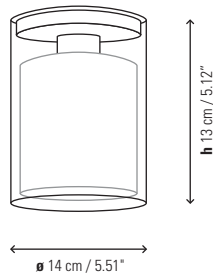

5131306 CROMO / CHROME

Pantalla 19 x 14 cm / Lampshade 7.48" x 5.51"

- P-734C CINTA TRANSLÚCIDA BLANCA / WHITE TRANSLUCENT RIBBON
- P-735C CINTA TRANSLÚCIDA CREMA / CREAM TRANSLUCENT RIBBON
- P-736C CINTA TRANSLÚCIDA ROJA / RED TRANSLUCENT RIBBON
- P-737C COTONET BLANCO / WHITE COTTON
- P-738C COTONET NEGRO / BLACK COTTON
- P-739C BLANCO INTERIOR NARANJA / WHITE-ORANGE INNER
- P-740C NEGRO INTERIOR NARANJA / BLACK-ORANGE INNER

Bombilla incluida / Bulb included

Material: Cristal borosilicato / Borosilicate glass



FAMÍLIA / FAMILY

PAG. 164 206

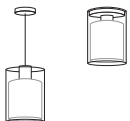

ACABADOS / FINISHING

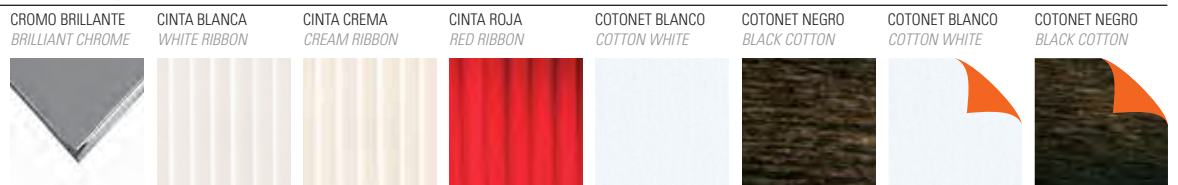





dermofarmàcia | benestar

dietètica, herboristeria
CONTROL DE PES / PLANTES MEDICINALS / VITAMINES / NUTRACÈUT





PLAFONET - 01
FONDA EUROPA

PLAFÓN
CEILING



2 x 42 W Classic P ECO E-27

2 x 14 W E-27

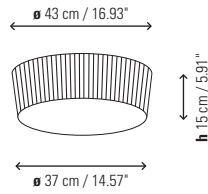

- 0124907 C LATÓN-CINTA TRANSLÚCIDA CREMA
BRASS-CREAM TRANSLUCENT RIBBON
- 0124905 C INOX-CINTA TRANSLÚCIDA CREMA
INOX-CREAM TRANSLUCENT RIBBON
- 0124907 B LATÓN-CINTA TRANSLÚCIDA BLANCA
BRASS-WHITE TRANSLUCENT RIBBON
- 0124905 B INOX-CINTA TRANSLÚCIDA BLANCA
INOX-WHITE TRANSLUCENT RIBBON
- 0124907 T LATÓN-COTONET BLANCO / *BRASS-WHITE COTTON*
- 0124905 T INOX-COTONET BLANCO / *INOX-WHITE COTTON*

Difusor cristal opal / *Diffuser opal glass*

PLAFONET - 02
FONDA EUROPA

PLAFÓN
CEILING



4 x 42 W Classic P ECO E-27

4 x 14 W E-27

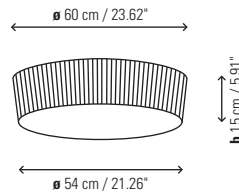

- 0224907 C LATÓN-CINTA TRANSLÚCIDA CREMA
BRASS-CREAM TRANSLUCENT RIBBON
- 0224905 C INOX-CINTA TRANSLÚCIDA CREMA
INOX-CREAM TRANSLUCENT RIBBON
- 0224907 B LATÓN-CINTA TRANSLÚCIDA BLANCA
BRASS-WHITE TRANSLUCENT RIBBON
- 0224905 B INOX-CINTA TRANSLÚCIDA BLANCA
INOX-WHITE TRANSLUCENT RIBBON
- 0224907 T LATÓN-COTONET BLANCO / *BRASS-WHITE COTTON*
- 0224905 T INOX-COTONET BLANCO / *INOX-WHITE COTTON*

Difusor cristal opal / *Diffuser opal glass*

Fotometría disponible / *Photometry available*

PLAFONET - 03
FONDA EUROPA

PLAFÓN
CEILING



6 x 22 W E-27

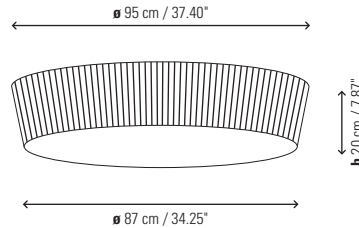

- 0324907 C LATÓN-CINTA TRANSLÚCIDA CREMA
BRASS-CREAM TRANSLUCENT RIBBON
- 0324905 C INOX-CINTA TRANSLÚCIDA CREMA
INOX-CREAM TRANSLUCENT RIBBON
- 0324907 B LATÓN-CINTA TRANSLÚCIDA BLANCA
BRASS-WHITE TRANSLUCENT RIBBON
- 0324905 B INOX-CINTA TRANSLÚCIDA BLANCA
INOX-WHITE TRANSLUCENT RIBBON
- 0324907 T LATÓN-COTONET BLANCO / *BRASS-WHITE COTTON*
- 0324905 T INOX-COTONET BLANCO / *INOX-WHITE COTTON*

Difusor metacrilato opal / *Diffuser opal methacrylate*

Fotometría disponible / *Photometry available*

ACABADOS / FINISHING

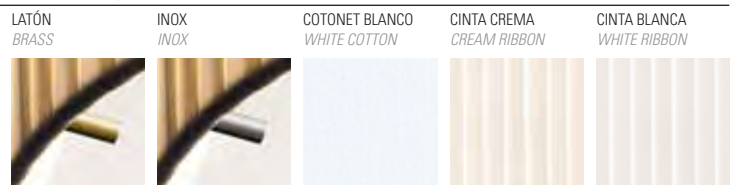







RONDO - F

PLAFÓN
CEILING



1 x 55 W T5 Circular

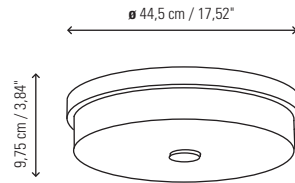

- 5015005F NÍQUEL SATINADO / SATIN NICKEL
- 5015006F CROMO BRILLANTE / BRILLIANT CHROME
- 5015008F GRIS GRAFITO / GREY GRAPHITE

Interior pantalla cotonet en poliéster / Inner cotton shade in polyester

- P-576 CINTA TRANSLÚCIDA BLANCA / WHITE TRANSLUCENT RIBBON
- P-577 CINTA TRANSLÚCIDA CREMA / CREAM TRANSLUCENT RIBBON
- P-578 COTONET BLANCO / WHITE COTTON

Difusor: cristal óptico mate / Diffuser: optical matte glass diffuser

RONDO - I

PLAFÓN
CEILING



4 x 42 W Classic P ECO E-14

4 x 11 W E-14

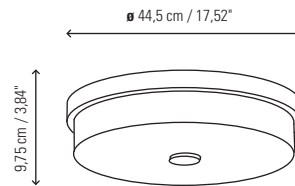

- 5015005I NÍQUEL SATINADO / SATIN NICKEL
- 5015006I CROMO BRILLANTE / BRILLIANT CHROME
- 5015008I GRIS GRAFITO / GREY GRAPHITE

Interior pantalla cotonet en poliéster / Inner cotton shade in polyester

- P-576 CINTA TRANSLÚCIDA BLANCA / WHITE TRANSLUCENT RIBBON
- P-577 CINTA TRANSLÚCIDA CREMA / CREAM TRANSLUCENT RIBBON
- P-578 COTONET BLANCO / WHITE COTTON

Difusor: cristal óptico mate / Diffuser: optical matte glass diffuser



ACABADOS / FINISHING





SIAM - 01

PLAFÓN
CEILING



3 x 22 W E-27

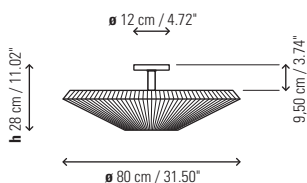

SIAM - 02

PLAFÓN
CEILING



6 x 42 W Classic P ECO E-27

6 x 30 W E-27

BIG FORMAT

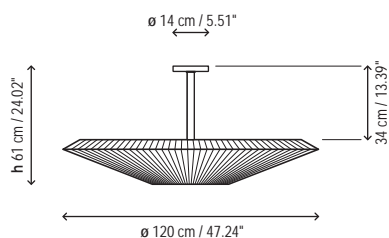
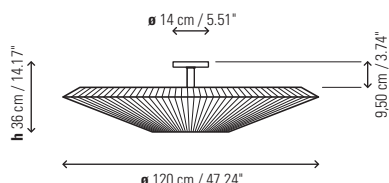

SIAM - 03

PLAFÓN
CEILING



8 x 42 W Classic P ECO E-27

8 x 30 W E-27

SIAM - 03 LED DIMABLE

OPCIONAL / OPTIONAL

 Led: 135 W
 Lumens: 10.100 lm
 Grados Kelvin: 2.600°
 Degrees Kelvin: 2.600°

BIG FORMAT

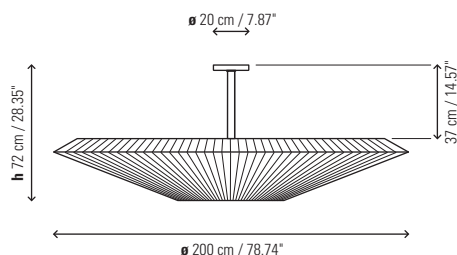
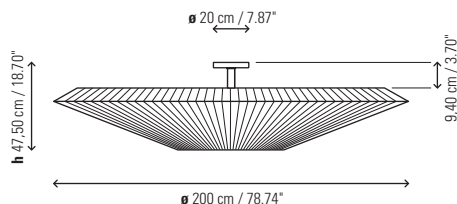

- 0132005 ESTRUCTURA NÍQUEL SATINADO / SATIN NICKEL
- 0132001 ESTRUCTURA BLANCO 9010 CRUDO / WHITE 9010

Pantalla / Lampshade:

- P-686C CINTA TRANSLÚCIDA BLANCA / WHITE TRANSLUCENT RIBBON
- P-687C CINTA TRANSLÚCIDA CREMA / CREAM TRANSLUCENT RIBBON
- P-688C CINTA TRANSLÚCIDA ROJA / RED TRANSLUCENT RIBBON

- 0232005P ESTRUCTURA NÍQUEL SATINADO / SATIN NICKEL
- 0232001P ESTRUCTURA BLANCO 9010 CRUDO / WHITE 9010
- 0232005G ESTRUCTURA GRANDE NÍQUEL SATINADO / SATIN NICKEL
- 0232001G ESTRUCTURA GRANDE BLANCO 9010 CRUDO / WHITE 9010

Pantalla / Lampshade:

- P-698C CINTA TRANSLÚCIDA BLANCA / WHITE TRANSLUCENT RIBBON
- P-699C CINTA TRANSLÚCIDA CREMA / CREAM TRANSLUCENT RIBBON
- P-700C CINTA TRANSLÚCIDA ROJA / RED TRANSLUCENT RIBBON

 Fotometría disponible / Photometry available

Este plafón permite realizar distintas composiciones individuales o en grupos. Existen dos medidas: Estructura 185 cm y Estructura 430 cm. Sobreponiendo las pantallas parcialmente, unas sobre las otras, conseguiremos crear un mural adecuado a cada espacio y necesidad.

This ceiling lamp allows several individual or group compositions. Available in two sizes: 185 cm and 430 cm structure. Superimposing shades partially, one on another, we will obtain a mural suitable for each space and need.

- 0332005P ESTRUCTURA 185 NÍQUEL SATINADO / SATIN NICKEL
- 0332001P ESTRUCTURA 185 BLANCO 9010 CRUDO / WHITE 9010
- 0332005G ESTRUCTURA 430 NÍQUEL SATINADO / SATIN NICKEL
- 0332001G ESTRUCTURA 430 BLANCO 9010 CRUDO / WHITE 9010

- D0332005LP ESTRUCTURA 185 NÍQUEL SATINADO / SATIN NICKEL
- D0332001LP ESTRUCTURA 185 BLANCO 9010 CRUDO / WHITE 9010
- D0332005LG ESTRUCTURA 430 NÍQUEL SATINADO / SATIN NICKEL
- D0332001LG ESTRUCTURA 430 BLANCO 9010 CRUDO / WHITE 9010

Pantalla / Lampshade:

- P-690C CINTA TRANSLÚCIDA BLANCA / WHITE TRANSLUCENT RIBBON
- P-691C CINTA TRANSLÚCIDA CREMA / CREAM TRANSLUCENT RIBBON
- P-692C CINTA TRANSLÚCIDA ROJA / RED TRANSLUCENT RIBBON

 Fotometría disponible / Photometry available
ECO Classic / ECO Classic

Este plafón permite realizar distintas composiciones individuales o en grupos. Existen dos medidas: Estructura 185 cm y Estructura 430 cm. Sobreponiendo las pantallas parcialmente, unas sobre las otras, conseguiremos crear un mural adecuado a cada espacio y necesidad.

This ceiling lamp allows several individual or group compositions. Available in two sizes: 185 cm and 430 cm structure. Superimposing shades partially, one on another, we will obtain a mural suitable for each space and need.

FAMÍLIA / FAMILY

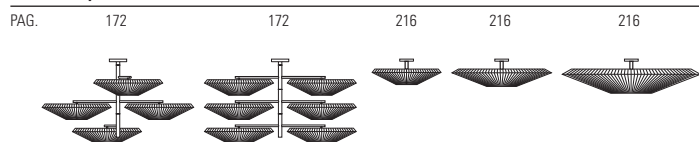

ACABADOS / FINISHING









URBAN - 01

PLAFÓN
CEILING



2 x 42 W Classic P ECO E-27

2 x 22 W E-27

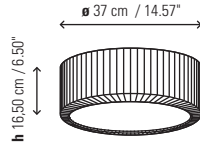

URBAN - 02

PLAFÓN
CEILING



4 x 42 W Classic P ECO E-27

4 x 22 W E-27

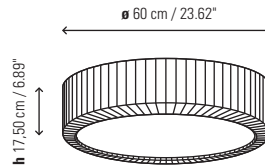

URBAN - 02

PLAFÓN
CEILING



1 x 40 W T5 Circular
+
1 x 60 W T5 Circular

URBAN - 03

PLAFÓN
CEILING



6 x 36 W 2G11

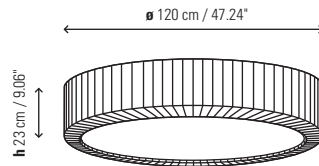

- 0132506 B CROMO-CINTA TRANSLÚCIDA BLANCA
CHROME-WHITE TRANSLUCENT RIBBON
- 0132506 C CROMO-CINTA TRANSLÚCIDA CREMA
CHROME-CREAM TRANSLUCENT RIBBON
- 0132506 R CROMO-CINTA TRANSLÚCIDA ROJA
CHROME-RED TRANSLUCENT RIBBON

R01325DIF Difusor de cristal + aro / *Glass diffuser + ring*

Fotometría disponible / *Photometry available*

- 0232506 B CROMO-CINTA TRANSLÚCIDA BLANCA
CHROME-WHITE TRANSLUCENT RIBBON
- 0232506 C CROMO-CINTA TRANSLÚCIDA CREMA
CHROME-CREAM TRANSLUCENT RIBBON
- 0232506 R CROMO-CINTA TRANSLÚCIDA ROJA
CHROME-RED TRANSLUCENT RIBBON

R02325DIF Difusor de cristal + aro / *Glass diffuser + ring*

- D0232506 B REACTANCIA DIMABLE/CROMO-CINTA TRANSLÚCIDA BLANCA
DIMMING BALLAST/CHROME-WHITE TRANSLUCENT RIBBON
- D0232506 C REACTANCIA DIMABLE/CROMO-CINTA TRANSLÚCIDA CREMA
DIMMING BALLAST/CHROME-CREAM TRANSLUCENT RIBBON
- D0232506 R REACTANCIA DIMABLE/CROMO-CINTA TRANSLÚCIDA ROJA
DIMMING BALLAST/CHROME-RED TRANSLUCENT RIBBON

R02325DIF Difusor de cristal + aro / *Glass diffuser + ring*

Fotometría disponible / *Photometry available*

- 0332506 B CROMO-CINTA TRANSLÚCIDA BLANCA
CHROME-WHITE TRANSLUCENT RIBBON
- 0332506 C CROMO-CINTA TRANSLÚCIDA CREMA
CHROME-CREAM TRANSLUCENT RIBBON
- 0332506 R CROMO-CINTA TRANSLÚCIDA ROJA
CHROME-RED TRANSLUCENT RIBBON

- D0332506 B REACTANCIA DIMABLE/CROMO-CINTA TRANSLÚCIDA BLANCA
DIMMING BALLAST/CHROME-WHITE TRANSLUCENT RIBBON
- D0332506 C REACTANCIA DIMABLE/CROMO-CINTA TRANSLÚCIDA CREMA
DIMMING BALLAST/CHROME-CREAM TRANSLUCENT RIBBON
- D0332506 R REACTANCIA DIMABLE/CROMO-CINTA TRANSLÚCIDA ROJA
DIMMING BALLAST/CHROME-RED TRANSLUCENT RIBBON

R03325DIF Difusor metacrilato / *Methacrylate diffuser*

Fotometría disponible / *Photometry available*

FAMILIA / FAMILY

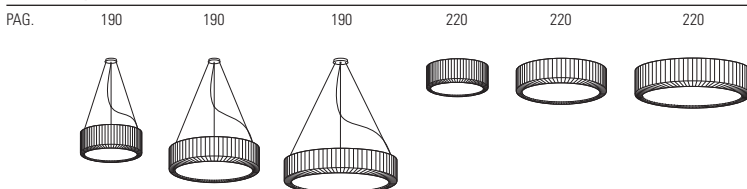

ACABADOS / FINISHING

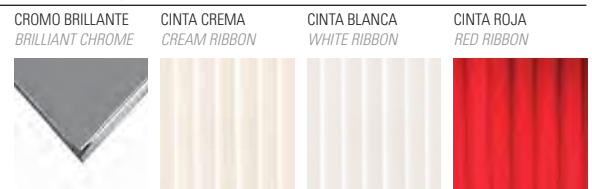



BIG FORMAT





MESA *TABLE LAMP*



CARLOTA

ESCRITORIO
DESK LAMP



1 x 42 W Classic P ECO E-27

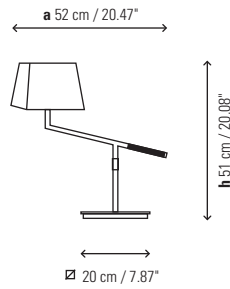

- 1924005 NÍQUEL SATINADO / SATIN NICKEL
- 1924006 CROMO BRILLANTE / BRILLIANT CHROME
- 1924060 NÍQUEL PIEL OSCURA / NICKEL DARK LEATHER
- 1924061 NÍQUEL PIEL CUERO / NICKEL CARAMEL LEATHER

Pantalla cuadrada 20 x 15 x 10 cm
Square lampshade 7.87" x 5.91" x 3.94"

- P-107 COTONET / COTTON
- P-202 CINTA TRANSLÚCIDA BLANCA / WHITE TRANSLUCENT RIBBON
- P-203 CINTA TRANSLÚCIDA CREMA / CREAM TRANSLUCENT RIBBON

Brazo móvil / Swivel arm

ACABADOS / FINISHING

COTONET
COTTON

CINTA CREMA
CREAM RIBBON

CINTA BLANCA
WHITE RIBBON



FAMÍLIA / FAMILY

PAG. 48 48 48 50 50 226 264

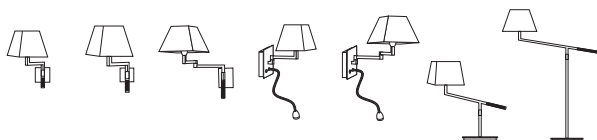

CROMO BRILLANTE
BRILLIANT CHROME

NÍQUEL SATINADO
SATIN NICKEL

PIEL OSCURA
DARK LEATHER

PIEL CLARA
CARAMEL LEATHER

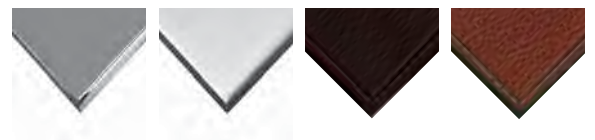



CLUB - T

MESA
TABLE



1 x 42 W Classic P ECO E-27

1 x 11 W E-27

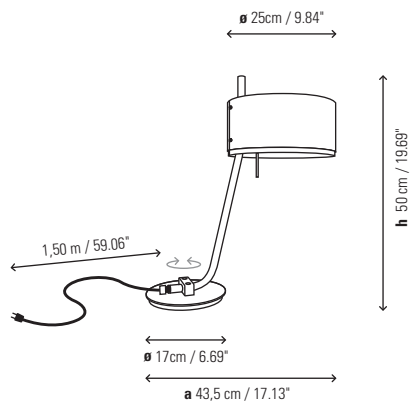

1932812 NEGRO MATE-NÍQUEL / MATTE BLACK-NICKEL

PANTALLA / LAMPSHADE

Pantalla aluminio negro / Black aluminum shade
Interior PVC blanco B1 Flame Resistant
White PVC interior B1 Flame Resistant
Incluye difusor superior de aluminio
Included aluminum top diffuser

Base giratoria / Swivel base

Interruptor en portalamparas / Lampholder switch



FAMÍLIA / FAMILY

PAG. 52 52 108 228 266

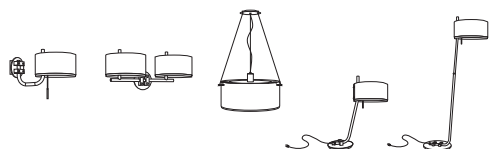

ACABADOS / FINISHING

NÍQUEL SATINADO
SATIN NICKEL

NEGRO MATE
MATTE BLACK

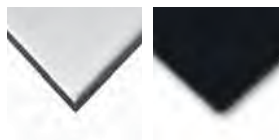



DANONA - MINI

MESITA
BEDSIDE



1 x 42 W Classic P ECO E-27

∅ 23 cm / 9.06"

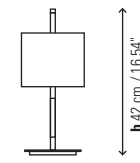

∅ 16 cm / 6.30"

h 42 cm / 16.54"

- 2023105 NÍQUEL SATINADO / SATIN NICKEL
- 2023160 NÍQUEL PIEL OSCURA / NICKEL DARK LEATHER
- 2023161 NÍQUEL PIEL CUERO / NICKEL CARAMEL LEATHER

Pantalla 23 x 17 x 23 cm / Lampshade 9.06" x 6.69" x 9.06"

Incluye difusor metacrilato + componentes pantalla

Lampshade components and methacrylate diffuser included

- P-230 COTONET / COTTON
- P-003 CINTA TRANSLÚCIDA CREMA / CREAM TRANSLUCENT RIBBON
- P-004 CINTA TRANSLÚCIDA BLANCA / WHITE TRANSLUCENT RIBBON

DANONA - MESA

MESA
TABLE



1 x 42 W Classic P ECO E-27

1 x 11 W E-27

∅ 27 cm / 10.63"

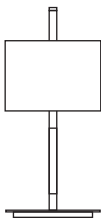

∅ 23 cm / 9.06"

h 51 cm / 20.08"

- 2123105 NÍQUEL SATINADO / SATIN NICKEL
- 2123160 NÍQUEL PIEL OSCURA / NICKEL DARK LEATHER
- 2123161 NÍQUEL PIEL CUERO / NICKEL CUIR LEATHER

Pantalla 27 x 18 x 27 cm / Lampshade 10.63" x 7.09" x 10.63"

Incluye difusor metacrilato + componentes pantalla

Lampshade components and methacrylate diffuser included

- P-227 COTONET / COTTON
- P-005 CINTA TRANSLÚCIDA CREMA / CREAM TRANSLUCENT RIBBON
- P-006 CINTA TRANSLÚCIDA BLANCA / WHITE TRANSLUCENT RIBBON

FAMÍLIA / FAMILY

PAG. 110 110 230 230 268

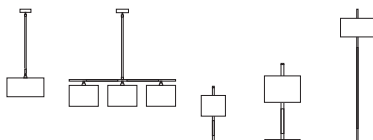

ACABADOS / FINISHING





EMA

MESA
TABLE



1 x 42 W Classic P ECO E-27

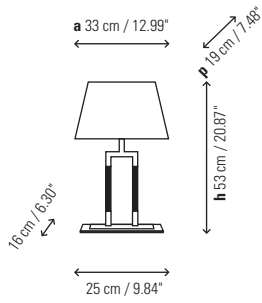

- 2119405 NÍQUEL SATINADO / SATIN NICKEL
- 2119460 NÍQUEL PIEL OSCURA / NICKEL DARK LEATHER
- 2119461 NÍQUEL PIEL CUERO / NICKEL CAMEL LEATHER

BASE INOX / INOX BASE

Acabado: Níquel satinado – Cromo brillante
Finish: Satin nickel – Brilliant chrome

Pantalla rectangular 33 x 19 x 21 cm
Rectangular lampshade 12.99" x 7.48" x 8.27"

- P-478 LINO / LINEN
- P-479 COTONET / COTTON

FAMÍLIA / FAMILY

PAG. 232 270



ACABADOS / FINISHING

CROMO BRILLANTE / BRILLIANT CHROME NÍQUEL SATINADO / SATIN NICKEL PIEL OSCURA / DARK LEATHER PIEL CLARA / CAMEL LEATHER COTONET / COTTON LINO / LINEN

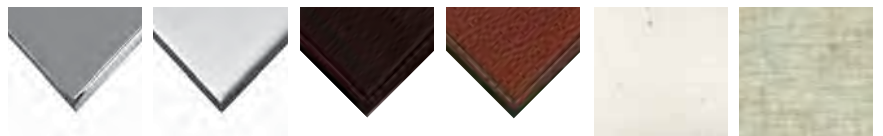



GIBSI - 01

MESA
TABLE



1 x 33 W G-9 (HALOPIN ECO)

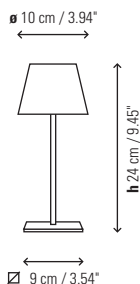

2018204 HIERRO NEGRO / BLACK IRON
2018205 NÍQUEL SATINADO / SATIN NICKEL

Pantalla cuadrada 10 x 9 x 7 cm / Square lampshade 3.94" x 3.54" x 2.76"

P-459 CINTA TRANSLÚCIDA BLANCA / WHITE TRANSLUCENT RIBBON
P-460 COTONET NEGRO / BLACK COTTON
P-463 CINTA TRANSLÚCIDA CREMA / CREAM TRANSLUCENT RIBBON
P-464 COTONET / COTTON
P-465 CINTA TRANSLÚCIDA ROJA / RED TRANSLUCENT RIBBON

GIBSI - 02

MESA
TABLE



1 x 33 W G-9 (HALOPIN ECO)

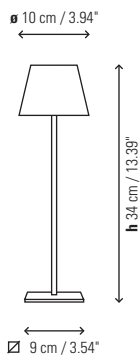

2118204 HIERRO NEGRO / BLACK IRON
2118205 NÍQUEL SATINADO / SATIN NICKEL

Pantalla cuadrada 10 x 9 x 7 cm / Square lampshade 3.94" x 3.54" x 2.76"

P-459 CINTA TRANSLÚCIDA BLANCA / WHITE TRANSLUCENT RIBBON
P-460 COTONET NEGRO / BLACK COTTON
P-463 CINTA TRANSLÚCIDA CREMA / CREAM TRANSLUCENT RIBBON
P-464 COTONET / COTTON
P-465 CINTA TRANSLÚCIDA ROJA / RED TRANSLUCENT RIBBON

GIBSI - 03

MESA
TABLE



1 x 33 W G-9 (HALOPIN ECO)

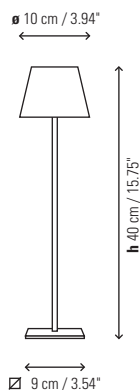

2218204 HIERRO NEGRO / BLACK IRON
2218205 NÍQUEL SATINADO / SATIN NICKEL

Pantalla cuadrada 10 x 9 x 7 cm / Square lampshade 3.94" x 3.54" x 2.76"

P-459 CINTA TRANSLÚCIDA BLANCA / WHITE TRANSLUCENT RIBBON
P-460 COTONET NEGRO / BLACK COTTON
P-463 CINTA TRANSLÚCIDA CREMA / CREAM TRANSLUCENT RIBBON
P-464 COTONET / COTTON
P-465 CINTA TRANSLÚCIDA ROJA / RED TRANSLUCENT RIBBON



Aconsejamos un uso máximo ininterrumpido de 4/5 horas debido al tamaño de la pantalla.

It is not recommended longer non-stop use of 4/5 hours due to the shade's measures.

ACABADOS / FINISHING

NÍQUEL SATINADO
SATIN NICKEL

HIERRO NEGRO
BLACK IRON

CINTA BLANCA
WHITE RIBBON

CINTA CREMA
CREAM RIBBON

COTONET
COTTON

COTONET NEGRO
BLACK COTTON

CINTA ROJA
RED RIBBON

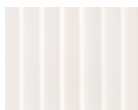



INARI

MESA
TABLE



3 x 42 W Classic P ECO E-27

3 x 18 W E-27 Osram Dulux INTELLIGENT DIMMABLE

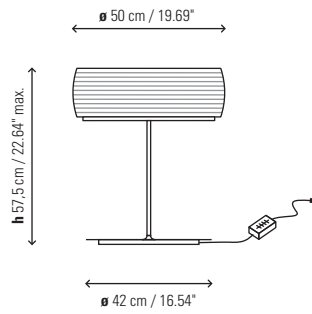

2220205 NÍQUEL-CRISTAL OPAL GRABADO
NICKEL-OPAL GLASS

2220206 CROMO-CRISTAL OPAL GRABADO
CHROME-OPAL GLASS

Lámpara con dimmer incorporado
Lamp with incorporated dimmer

Debido a la naturaleza del cristal soplado, pueden aparecer pequeñas burbujas o variaciones que no se consideran defectos.
Due to the nature of the hand blown cristal, natural variations should be expected and will not be considered an imperfection.

FAMÍLIA / FAMILY

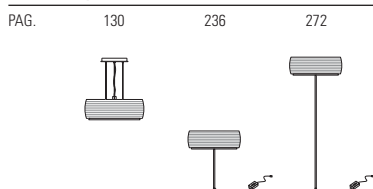

ACABADOS / FINISHING





MANI - MINI

MESITA
BEDSIDE



1 x 42 W Classic P ECO E-27

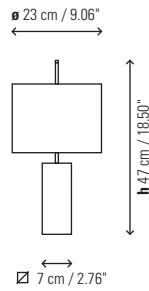

- 2028512 NÍQUEL HAYA NATURAL / NICKEL NATURAL WOOD
- 2028513 NÍQUEL HAYA CEREZO / NICKEL CHERRY WOOD
- 2028514 NÍQUEL HAYA WENGUE / NICKEL WALNUT WOOD

Pantalla 23 x 17 x 23 cm / Lampshade 9.06" x 6.69" x 9.06"
Incluye difusor metacrilato + componentes pantalla
Lampshade components and methacrylate diffuser included

- P-003 CINTA TRANSLÚCIDA CREMA / CREAM TRANSLUCENT RIBBON
- P-004 CINTA TRANSLÚCIDA BLANCA / WHITE TRANSLUCENT RIBBON
- P-230 COTONET / COTTON

MANI - MESA

MESA
TABLE



2 x 42 W Classic P ECO E-27

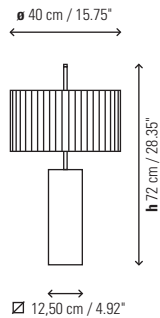

- 2128512 NÍQUEL HAYA NATURAL / NICKEL NATURAL WOOD
- 2128513 NÍQUEL HAYA CEREZO / NICKEL CHERRY WOOD
- 2128514 NÍQUEL HAYA WENGUE / NICKEL WALNUT WOOD

Pantalla 40 x 22 x 40 cm / Lampshade 15.75" x 8.66" x 15.75"
Incluye difusor metacrilato + componentes pantalla
Lampshade components and methacrylate diffuser included

- P-133 COTONET / COTTON
- P-137 CINTA TRANSLÚCIDA BLANCA / WHITE TRANSLUCENT RIBBON
- P-138 CINTA TRANSLÚCIDA CREMA / CREAM TRANSLUCENT RIBBON



ACABADOS / FINISHING

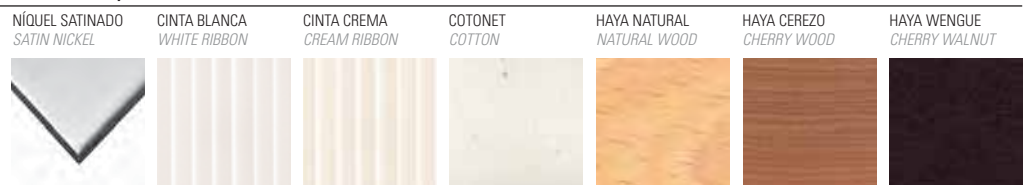



MEI OVAL - T

MESA
TABLE



1 x 42 W Classic P ECO E-27

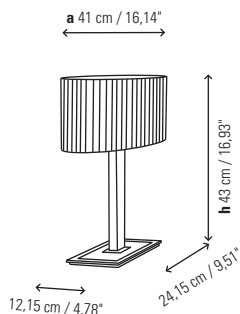

2125023 CROMO CRISTAL NEGRO / CHROME BLACK GLASS
2125017 NÍQUEL CRISTAL NEGRO / NICKEL BLACK GLASS

Pantalla oval 41 x 17,5 x 15 cm / Oval lampshade 16.14" x 6.89" x 5.91"

P-551D CINTA TRANSLÚCIDA BLANCA / WHITE TRANSLUCENT RIBBON
P-552D CINTA TRANSLÚCIDA CREMA / CREAM TRANSLUCENT RIBBON
P-553D CINTA TRANSLÚCIDA NEGRA / BLACK TRANSLUCENT RIBBON
P-554D COTONET BLANCO / WHITE COTTON

Difusor superior cristal negro / Upper diffuser black glass

MEI OVAL - T/USB

MESA
TABLE



1 x 42 W Classic P ECO E-27

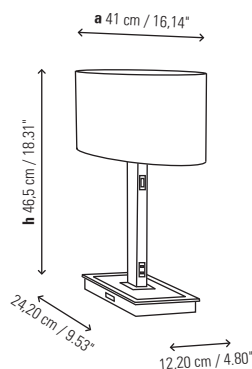

2125017USB NÍQUEL CRISTAL NEGRO / NICKEL BLACK GLASS
2125023USB CROMO CRISTAL NEGRO / CHROME BLACK GLASS

Pantalla oval 41 x 17,5 x 15 cm / Oval lampshade 16.14" x 6.30" x 5.91"

P-551D CINTA TRANSLÚCIDA BLANCA / WHITE TRANSLUCENT RIBBON
P-552D CINTA TRANSLÚCIDA CREMA / CREAM TRANSLUCENT RIBBON
P-553D CINTA TRANSLÚCIDA NEGRA / BLACK TRANSLUCENT RIBBON
P-554D COTONET BLANCO / WHITE COTTON

Difusor superior cristal negro / Upper diffuser black glass

Interruptor encendido situado en el mástil / On/off switch located on the stem

Enchufe situado en el mástil / Switch located on the stem

Entrada conector USB en la base / USB port located on the base

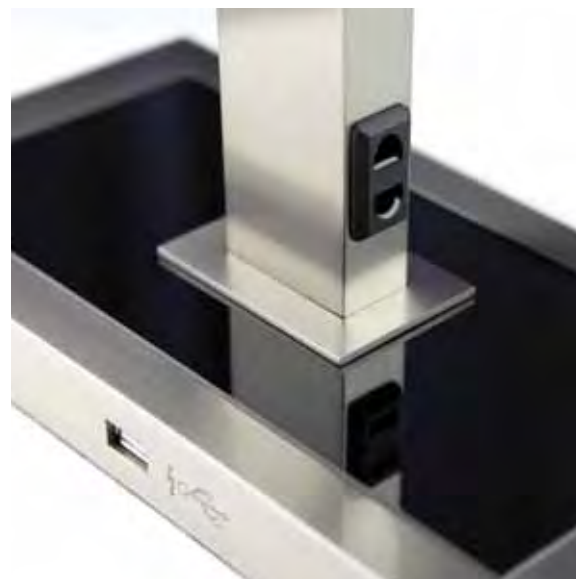

FAMÍLIA / FAMILY

PAG. 74 74 156 240 276

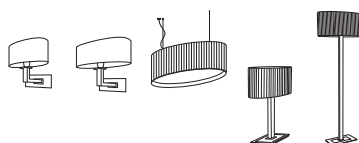

ACABADOS / FINISHING

CROMO BRILLANTE / BRILLIANT CHROME NÍQUEL SATINADO / SATIN NICKEL CRISTAL NEGRO / BLACK GLASS CINTA BLANCA / WHITE RIBBON CINTA CREMA / CREAM RIBBON CINTA NEGRA / BLACK RIBBON COTONET / COTTON





MUF - 01

MESA
TABLE



-  1 x 70 W Classic A ECO E-27
- +
-  1 x 18 W Classic P ECO E-14

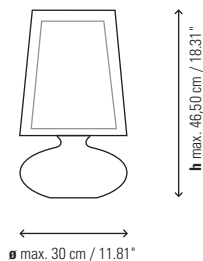

2215521 CRISTAL SOPLADO OPAL-CROMO
BLOWN OPAL GLASS-CHROME

Pantalla exterior: 27 x 27 x 20 cm
Outer lampshade: 10.63" x 10.63" x 7.87"

- P-561 CINTA TRANSLÚCIDA BLANCA / *WHITE TRANSLUCENT RIBBON*
- P-564E NEGRO / *BLACK MESH*
- P-565E ROJO / *RED MESH*

Pantalla Interior: 20 x 26 x 14 cm / *Inner lampshade: 7.87" x 10.24" x 5.51"*

- P-564 I NEGRO / *BLACK MESH*
- P-565 I ROJO / *RED MESH*

Lámpara con 3 posiciones de encendido
With 3 lighting/mood switch on/off positions

Interior pantalla de film poliéster rígido resistente al calor
Inner shade made of a fire-resistant polyester rigid film

MUF - 02

MESA
TABLE



-  1 x 70 W Classic A ECO E-27
- +
-  2 x 18 W Classic P ECO E-14

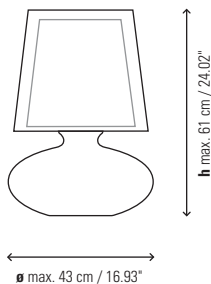

2215522 CRISTAL SOPLADO OPAL-CROMO
BLOWN OPAL GLASS-CHROME

Pantalla Exterior: 40 x 36 x 31 cm
Outer lampshade: 15.75" x 14.17" x 12.20"

- P-580 CINTA TRANSLÚCIDA BLANCA / *WHITE TRANSLUCENT RIBBON*
- P-570E NEGRO / *BLACK MESH*
- P-571E ROJO / *RED MESH*

Pantalla Interior: 30 x 30 x 23 / *Inner lampshade: 11.81" x 11.81" x 9.06"*

- P-570 I NEGRO / *BLACK MESH*
- P-571 I ROJO / *RED MESH*

Lámpara con 3 posiciones de encendido
With 3 lighting/mood switch on/off positions

Interior pantalla de film poliéster rígido resistente al calor
Inner shade made of a fire-resistant polyester rigid film



Debido a la naturaleza del cristal soplado, pueden aparecer pequeñas burbujas o variaciones que no se consideran defectos.
Due to the nature of the hand blown cristal, natural variations should be expected and will not be considered an imperfection.

ACABADOS / FINISHING

CINTA BLANCA <i>WHITE RIBBON</i>	MALLA NEGRA <i>BLACK MESH</i>	MALLA ROJA <i>RED MESH</i>
-------------------------------------	----------------------------------	-------------------------------









ONNE

MESA
TABLE



1 x 70 W Classic A ECO E-27

1 x 11 W E-27

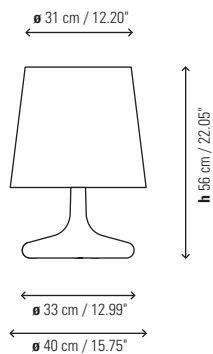

- 2210621 BLANCO LACADO BRILLANTE / *WHITE BRILLIANT LACQUER*
- 2210617 NEGRO LACADO BRILLANTE / *BLACK BRILLIANT LACQUER*
- 2210622 ROJO LACADO BRILLANTE / *RED BRILLIANT LACQUER*

Pantalla 40 x 35,5 x 31 cm / *Lampshade 15.75" x 13.98" x 12.20"*
 Incluye difusor metacrilato espejo para pantallas blancas y difusor metacrilato espejo negro para pantallas negras
Diffuser included: silver-mirror methacrylate with white shade and black-mirror methacrylate with black shade

- P-660 CINTA BLANCA
WHITE RIBBON
- P-658 NEGRO - INTERIOR NARANJA
BLACK FABRIC - ORANGE INSIDE
- P-659 BLANCO - INTERIOR NARANJA
WHITE FABRIC - ORANGE INSIDE
- P-761 CINTA ROJA
RED RIBBON

Material: Poliuretano / *Polyurethane*
 Acabado: Lacado brillante / *Brilliant lacquer*



ACABADOS / FINISHING









ROLANDITA - T

MESA
TABLE



1 x 100 W E-27 HALÓGENA

1 x 18 W E-27 Osram Dulux
INTELLIGENT DIMMABLE

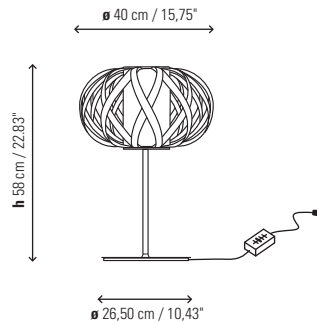

- 2122506 CROMO / CHROME
- 2122511 BLANCO-CROMO / WHITE CHROME
- 2122505 NÍQUEL-CROMO / NICKEL-CHROME
- 2122509 ORO SATIN-ORO BRILLANTE / SATIN GOLD-BRILLIANT GOLD

Material: fleje acero inoxidable calibrado
 Material: calibrated stainless steel strips
 Base acero inoxidable / Stainless steel base
 Difusor de cristal satinado / Satin glass diffuser
 Lámpara con dimmer incorporado / Lamp with incorporated dimmer
 Intensidad lumínica ajustable (sólo usando bombillas regulables)
 Adjustable light intensity by using dimming bulbs

ROLANDA - T

MESA
TABLE



1 x 100 W E-27 HALÓGENA

1 x 18 W E-27 Osram Dulux
INTELLIGENT DIMMABLE

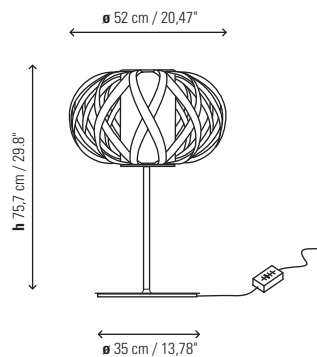

- 2222506 CROMO / CHROME
- 2222511 BLANCO-CROMO / WHITE CHROME
- 2222505 NÍQUEL-CROMO / NICKEL-CHROME
- 2222509 ORO SATIN-ORO BRILLANTE / SATIN GOLD-BRILLIANT GOLD

Material: fleje acero inoxidable calibrado
 Material: calibrated stainless steel strips
 Base acero inoxidable / Stainless steel base
 Difusor de cristal satinado / Satin glass diffuser
 Lámpara con dimmer incorporado / Lamp with incorporated dimmer
 Intensidad lumínica ajustable (sólo usando bombillas regulables)
 Adjustable light intensity by using dimming bulbs



FAMÍLIA / FAMILY

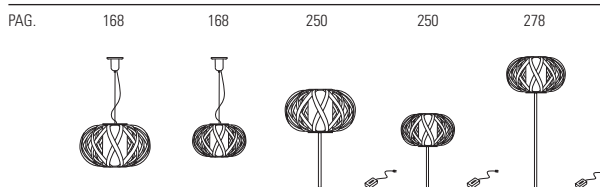

ACABADOS / FINISHING





SPOCK - MINI

MESA
TABLE



4 x 1.2 W LED
 Led: 4 x 1.2 W = 4.8 W Phillips
 Lumens: 85 x 4 = 340 lm
 Grados Kelvin 2.900º
 Degrees Kelvin: 2.900º
 Valor cromático / CRI: 85

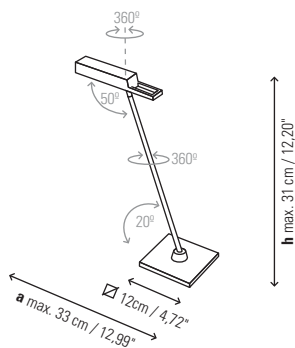

- 2010511L LED CROMO BLANCO / LED CHROME-WHITE
- 2010512L LED CROMO / LED CHROME
- 2010510L LED CROMO-GRAFITO / LED CHROME-GRAPHITE

Pantalla de inyección de zamac orientable
Zamac injected orientable hood
 Base de acero inoxidable / *Stainless steel base*

DIFUSOR / *DIFFUSER*:
 Rotación circular 360º / *Circular rotation 360º*
 Rotación vertical 50º / *Vertical rotation 50º*

MASTIL / *MAST*:
 Rotación circular 360º / *Circular rotation 360º*
 Inclinación mástil 20º / *Mast inclination 20º*

SPOCK - T

MESA
TABLE



4 x 1.2 W LED
 Led: 4 x 1.2 W = 4.8 W Phillips
 Lumens: 85 x 4 = 340 lm
 Grados Kelvin 2.900º
 Degrees Kelvin: 2.900º
 Valor cromático / CRI: 85

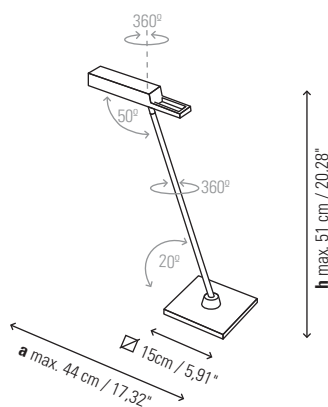

- 1910511L LED CROMO BLANCO / LED CHROME-WHITE
- 1910512L LED CROMO / LED CHROME
- 1910510L LED CROMO-GRAFITO / LED CHROME-GRAPHITE

Pantalla de inyección de zamac orientable
Zamac injected orientable hood
 Base de acero inoxidable / *Stainless steel base*

DIFUSOR / *DIFFUSER*:
 Rotación circular 360º / *Circular rotation 360º*
 Rotación vertical 50º / *Vertical rotation 50º*

MASTIL / *MAST*:
 Rotación circular 360º / *Circular rotation 360º*
 Inclinación mástil 20º / *Mast inclination 20º*



FAMÍLIA / FAMILY

PAG. 90 252 252 280

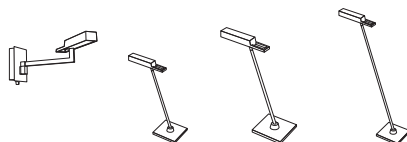

ACABADOS / FINISHING

CROMO BRILLANTE
BRIGHT CHROME BLANCO
WHITE GRAFITO
GRAPHITE









TAU - MINI

MESITA
BEDSIDE



1 x 42 W Classic P ECO E-27

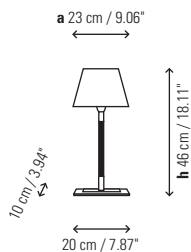

- 2023960 NÍQUEL PIEL OSCURA / NICKEL DARK LEATHER
- 2023961 NÍQUEL PIEL CUERO / NICKEL CARAMEL LEATHER
- 2023905 NÍQUEL SATINADO CROMO / SATIN NICKEL-CHROME

BASE INOX / INOX BASE

Acabado: Níquel satinado—Cromo brillante

Finish: Satin nickel—Brilliant chrome

Pantalla rectangular 23 x 13 x 15 cm

Rectangular lampshade 9.06" x 5.12" x 5.91"

- P-474 LINO / LINEN
- P-475 COTONET / COTTON
- P-671 CINTA TRANSLÚCIDA BLANCA / WHITE TRANSLUCENT RIBBON
- P-672 CINTA TRANSLÚCIDA CREMA / CREAM TRANSLUCENT RIBBON

TAU - MESA

MESA
TABLE



1 x 42 W Classic P ECO E-27

1 x 11 W E-27

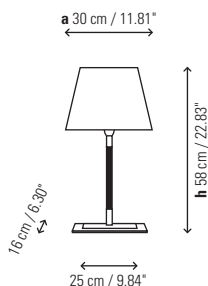

- 2223960 NÍQUEL PIEL OSCURA / NICKEL DARK LEATHER
- 2223961 NÍQUEL PIEL CUERO / NICKEL CARAMEL LEATHER
- 2223905 NÍQUEL SATINADO CROMO / SATIN NICKEL-CHROME

BASE INOX / INOX BASE

Acabado: Níquel satinado—Cromo brillante

Finish: Satin nickel—Brilliant chrome

Pantalla rectangular 33 x 22 x 21 cm

Rectangular lampshade 12.99" x 8.66" x 8.27"

- P-478 LINO / LINEN
- P-479 COTONET / COTTON
- P-674 CINTA TRANSLÚCIDA BLANCA / WHITE TRANSLUCENT RIBBON
- P-675 CINTA TRANSLÚCIDA CREMA / CREAM TRANSLUCENT RIBBON

FAMÍLIA / FAMILY

PAG. 180 256 256 282



ACABADOS / FINISHING

CROMO BRILLANTE
BRILLIANT CHROME

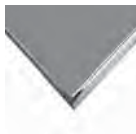

NÍQUEL SATINADO
SATIN NICKEL

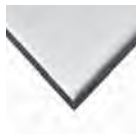

PIEL OSCURA
DARK LEATHER

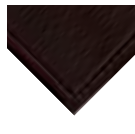

PIEL CLARA
CARAMEL LEATHER

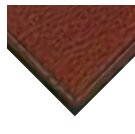

COTONET
COTTON

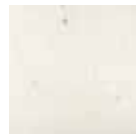

CINTA CREMA
CREAM RIBBON



CINTA BLANCA
WHITE RIBBON



LINO
LINEN

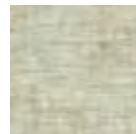



TAU - MADERA

MESA
TABLE



1 x 42 W Classic P ECO E-27

1 x 11 W E-27

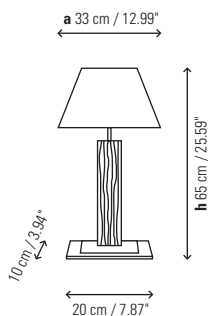

- 2123931 NÍQUEL CEREZO / NICKEL CHERRY
- 2123932 NÍQUEL WENGUÉ / NICKEL WENGUE
- 2123934 NÍQUEL CEBRANO / NICKEL CEBRANO
- 2123901 NÍQUEL BLANCO LACADO / NICKEL WHITE LACQUER

BASE INOX / INOX BASE

Acabado: Níquel satinado–Cromo brillante

Finish: Satin nickel–Brilliant chrome

Pantalla rectangular 33 x 22 x 21 cm

Rectangular lampshade 12.99" x 8.66" x 8.27"

- P-478 LINO / LINEN
- P-479 COTONET / COTTON
- P-541 COTONET BLANCO / WHITE COTTON
- P-674 CINTA TRANSLÚCIDA BLANCA / WHITE TRANSLUCENT RIBBON
- P-675 CINTA TRANSLÚCIDA CREMA / CREAM TRANSLUCENT RIBBON

La madera de cebrano puede sufrir variaciones propias de su naturaleza, no considerándose imperfecciones sus betas o su color. Cada pieza es única por sus propiedades.

Cebrano wood may undergo characteristic variations that are not considered to be imperfections in its grain or colour. Each piece is unique because of its properties.

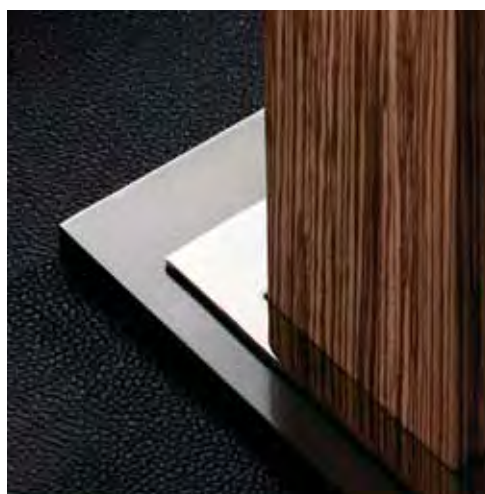

FAMÍLIA / FAMILY

PAG. 258 284



ACABADOS / FINISHING

CROMO BRILLANTE BRILLIANT CHROME	NÍQUEL SATINADO SATIN NICKEL	WENGUÉ WENGUE	CEBRANO CEBRANO	LACADO BLANCO WHITE LACQUER	CEREZO CHERRY	LINO LINEN	COTONET COTTON	COTONET BLANCO COTTON WHITE	CINTA CREMA CREAM RIBBON	CINTA BLANCA WHITE RIBBON
-------------------------------------	---------------------------------	------------------	--------------------	--------------------------------	------------------	---------------	-------------------	--------------------------------	-----------------------------	------------------------------





ULMA - MESA

MESA
TABLE



1 x 70 W Classic A ECO E-27

1 x 18 W E-27

a 35 cm / 13.78"



H 64 cm / 25.20"

18 cm / 7.09"

- 2122860 NÍQUEL PIEL OSCURA / *NICKEL DARK LEATHER*
- 2122861 NÍQUEL PIEL CUERO / *NICKEL CARAMEL LEATHER*

Pantalla cuadrada 35 x 24 x 18 cm
Square lampshade 13.78" x 9.45" x 7.09"

- P-195 COTONET / *COTTON*
- P-117 CINTA TRANSLÚCIDA CREMA / *CREAM TRANSLUCENT RIBBON*
- P-118 CINTA TRANSLÚCIDA BLANCA / *WHITE TRANSLUCENT RIBBON*



FAMÍLIA / FAMILY

PAG. 260 288

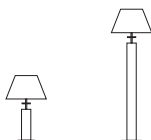

ACABADOS / FINISHING

NÍQUEL SATINADO / *SATIN NICKEL* PIEL OSCURA / *DARK LEATHER* PIEL CLARA / *CARAMEL LEATHER* COTONET / *COTTON* CINTA CREMA / *CREAM RIBBON* CINTA BLANCA / *WHITE RIBBON*

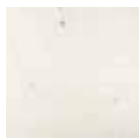
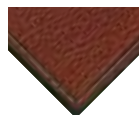
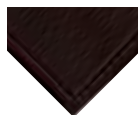
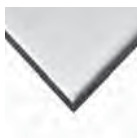



PIE
FLOOR LAMP



CARLOTA - PIE

PIE
FLOOR



1 x 42 W Classic P ECO E-27

1 x 11 W E-27

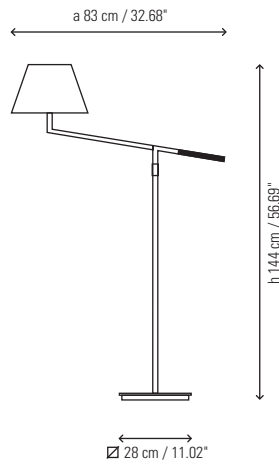

- 3124005 NÍQUEL SATINADO / SATIN NICKEL
- 3124006 CROMO BRILLANTE / BRILLIANT CHROME
- 3124060 NÍQUEL PIEL OSCURA / NICKEL DARK LEATHER
- 3124061 NÍQUEL PIEL CUERO / NICKEL CARAMEL LEATHER

Pantalla cuadrada 27 x 21 x 15 cm
Square lampshade 10.63" x 8.27" x 5.91"

- P-453 COTONET / COTTON
- P-455 CINTA TRANSLÚCIDA BLANCA / WHITE TRANSLUCENT RIBBON
- P-456 CINTA TRANSLÚCIDA CREMA / CREAM TRANSLUCENT RIBBON

Brazo móvil / Swivel arm

ACABADOS / FINISHING

COTONET COTTON	CINTA CREMA CREAM RIBBON	CINTA BLANCA WHITE RIBBON
-------------------	-----------------------------	------------------------------



FAMÍLIA / FAMILY

PAG. 48 48 48 50 50 226 264

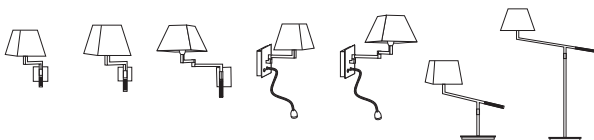

CROMO BRILLANTE BRILLIANT CHROME	NÍQUEL SATINADO SATIN NICKEL	PIEL OSCURA DARK LEATHER	PIEL CLARA CARAMEL LEATHER
-------------------------------------	---------------------------------	-----------------------------	-------------------------------

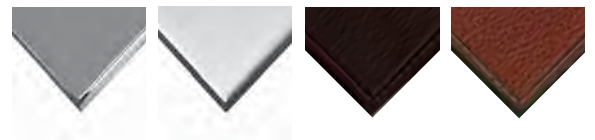



CLUB - P

PIE
FLOOR



1 x 52 W Classic P ECO E-27

1 x 22 W E-27

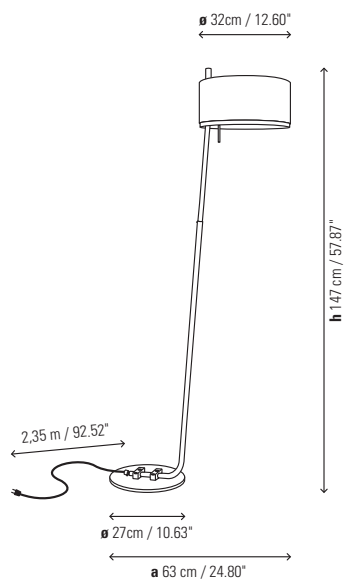

3132812 NEGRO MATE-NÍQUEL / MATTE BLACK-NICKEL

Pantalla aluminio negro
Black aluminum shade
Interior PVC blanco B1 Flame Resistant
White PVC interior B1 Flame Resistant
Incluye difusor superior de aluminio
Included aluminum top diffuser

Interruptor en portalamparas
Lampholder swicht



FAMÍLIA / FAMILY

PAG. 52 52 108 228 266

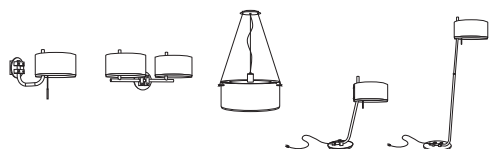

ACABADOS / FINISHING

NÍQUEL SATINADO SATIN NICKEL

NEGRO MATE MATTE BLACK

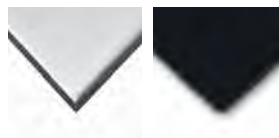



DANONA - PIE

PIE
FLOOR



2 x 42 W Classic P ECO E-27

2 x 11 W E-27

∅ 40 cm / 15.75"

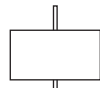

h 165 cm / 64.96"



∅ 30 cm / 11.81"

- 3023105 NÍQUEL SATINADO / SATIN NICKEL
- 3023160 NÍQUEL PIEL OSCURA / NICKEL DARK LEATHER
- 3023161 NÍQUEL PIEL CUERO / NICKEL CAMEL LEATHER

Pantalla 40 x 22 x 40 cm / Lampshade 15.75" x 8.66" x 15.75"

Incluye difusor metacrilato + componentes pantalla

Lampshade components and methacrylate diffuser included

- P-133 COTONET / COTTON
- P-137 CINTA TRANSLÚCIDA BLANCA / WHITE TRANSLUCENT RIBBON
- P-138 CINTA TRANSLÚCIDA CREMA / CREAM TRANSLUCENT RIBBON

FAMÍLIA / FAMILY

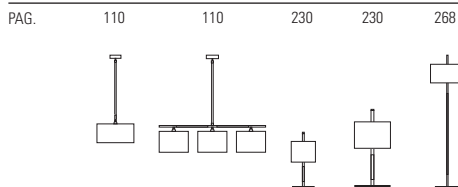

ACABADOS / FINISHING

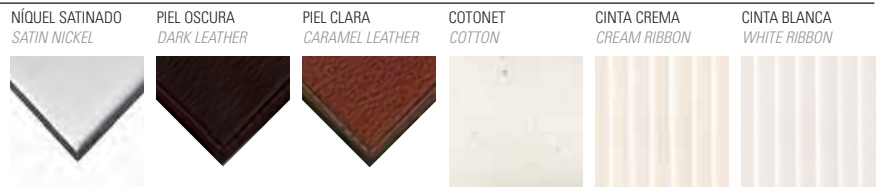



EMA - PIE

PIE
FLOOR



1 x 42 W Classic P ECO E-27

1 x 11 W E-27

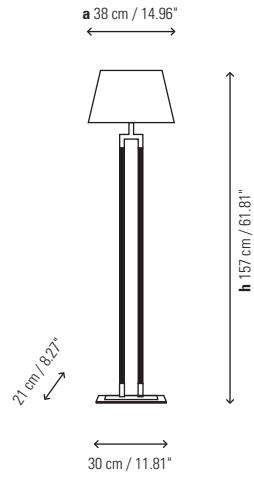

- 3019405 NÍQUEL SATINADO / SATIN NICKEL
- 3019460 NÍQUEL PIEL OSCURA / NICKEL DARK LEATHER
- 3019461 NÍQUEL PIEL CUERO / NICKEL CAMEL LEATHER

Material: BASE INOX / INOX BASE
Acabado: Níquel satinado – Cromo brillante
Finish: Satin nickel – Brilliant chrome

Pantalla rectangular 38 x 22 x 25 cm
Rectangular lampshade 14.96" x 8.66" x 9.84"

- P-480 LINO / LINEN
- P-481 COTONET / COTTON

FAMÍLIA / FAMILY

PAG. 232 270



ACABADOS / FINISHING





INARI - PIE

PIE
FLOOR



3 x 52 W Classic A ECO E-27

3 x 18 W E-27 Osram Dulux INTELLIGENT DIMMABLE

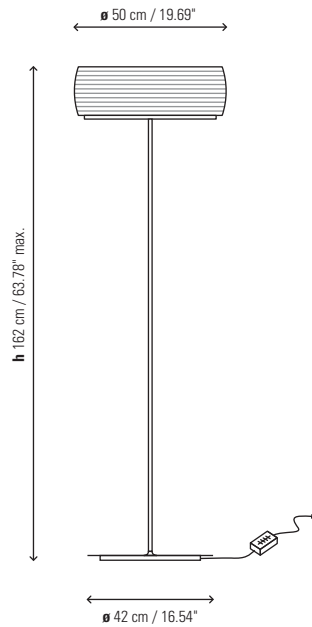

3020205 NÍQUEL-CRISTAL OPAL GRABADO
NICKEL-OPAL GLASS

3020206 CROMO-CRISTAL OPAL GRABADO
CHROME-OPAL GLASS

Lámpara con dimmer incorporado
Lamp with incorporated dimmer

Intensidad lumínica ajustable, sólo usando bombillas regulables.
Adjustable light intensity by using dimming bulbs.

Debido a la naturaleza del cristal soplado, pueden aparecer pequeñas burbujas o variaciones que no se consideran defectos.
Due to the nature of the hand blown cristal, natural variations should be expected and will not be considered an imperfection.

FAMÍLIA / FAMILY

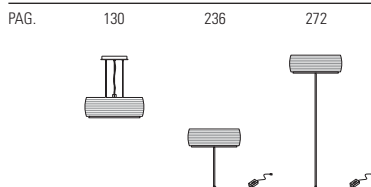

ACABADOS / FINISHING

CROMO BRILLANTE
BRILLIANT CHROME

NÍQUEL SATINADO
SATIN NICKEL

CRISTAL OPAL GRABADO
OPAL GLASS





MAXI - 01

PIE
FLOOR



4 x 42 W Classic P ECO E-27

4 x 30 W E-27

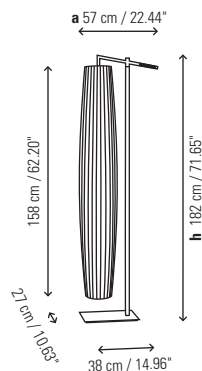

- 3019505 NÍQUEL SATINADO / SATIN NICKEL
- 3019560 NÍQUEL PIEL OSCURA / NICKEL DARK LEATHER
- 3019561 NÍQUEL PIEL CUERO / NICKEL CARAMEL LEATHER

Pantalla 158 x 25 cm / Lampshade 62.20" x 9.84"

- P-507T TOP CINTA CREMA / TOP CREAM RIBBON
- P-508T TOP CINTA BLANCA / TOP WHITE RIBBON

Bombillas Eco Classic incluidas / Eco Classic bulbs included

MAXI - 02

PIE
FLOOR



4 x 42 W Classic P ECO E-27

4 x 30 W E-27

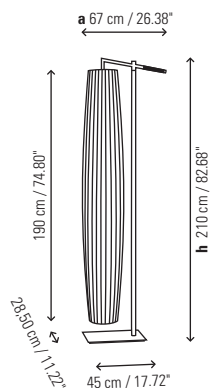

- 3219505 NÍQUEL SATINADO / SATIN NICKEL
- 3219560 NÍQUEL PIEL OSCURA / NICKEL DARK LEATHER
- 3219561 NÍQUEL PIEL CUERO / NICKEL CARAMEL LEATHER

Pantalla 190 x 30 cm / Lampshade 74.80" x 11.81"

- P-506T TOP CINTA CREMA / TOP CREAM RIBBON
- P-509T TOP CINTA BLANCA / TOP WHITE RIBBON

Bombillas Eco Classic incluidas / Eco Classic bulbs included



FAMÍLIA / FAMILY

PAG. 32 32 32 142 142 142 274 274

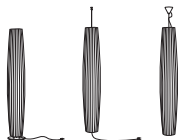

EXTERIOR / OUTDOOR



INTERIOR / INDOOR

ACABADOS / FINISHING

NÍQUEL SATINADO SATIN NICKEL PIEL OSCURA DARK LEATHER PIEL CLARA CARAMEL LEATHER CINTA CREMA CREAM RIBBON CINTA BLANCA WHITE RIBBON

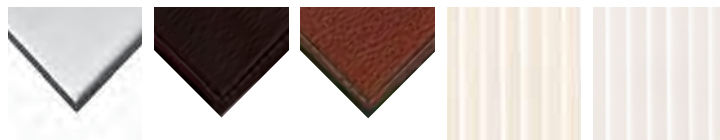



MEI OVAL - P

PIE
FLOOR



1 x 70 W Classic A ECO E-27

1 x 18 W E-27

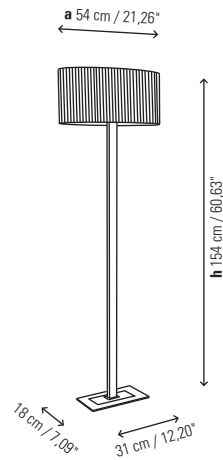

3025023 CROMO CRISTAL NEGRO / CHROME BLACK GLASS
3025017 NÍQUEL CRISTAL NEGRO / NICKEL BLACK GLASS

Pantalla oval 54 x 24 x 23 cm / Oval lampshade 21.26" x 9.45" x 9.06"

P-557 CINTA TRANSLÚCIDA BLANCA / WHITE TRANSLUCENT RIBBON
P-558 CINTA TRANSLÚCIDA CREMA / CREAM TRANSLUCENT RIBBON
P-559 CINTA TRANSLÚCIDA NEGRA / BLACK TRANSLUCENT RIBBON
P-560 COTONET BLANCO / WHITE COTTON

FAMÍLIA / FAMILY

PAG. 74 74 156 240 276

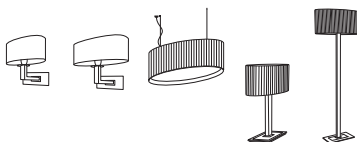

ACABADOS / FINISHING





ROLANDA - P

PIE
FLOOR



1 x 100 W E-27 HALÓGENA

1 x 18 W E-27 Osram Dulux
INTELLIGENT DIMMABLE

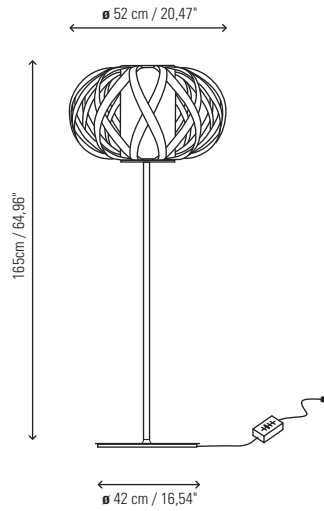

- 3022506 CROMO / CHROME
- 3022511 BLANCO-CROMO / WHITE-CHROME
- 3022505 NÍQUEL-CROMO / NICKEL-CHROME
- 3022509 ORO SATIN-ORO BRILLANTE / SATIN GOLD-BRILLIANT GOLD

Material: fleje acero inoxidable calibrado
Material: calibrated stainless steel strips
 Base acero inoxidable / *Stainless steel base*
 Difusor de cristal satinado / *Satin glass diffuser*
 Lámpara con dimmer incorporado / *Lamp with incorporated dimmer*
 Intensidad lumínica ajustable (sólo usando bombillas regulables)
Adjustable light intensity by using dimming bulbs

FAMÍLIA / FAMILY

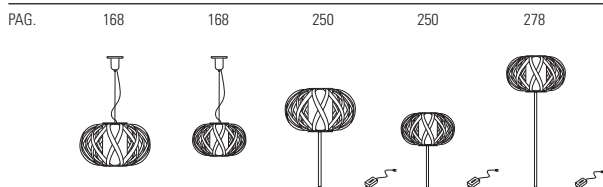

ACABADOS / FINISHING





SPOCK - P

PIE
FLOOR



4 x 1.2 W LED
 Led: 4 x 1.2 W = 4.8 W Phillips
 Lumens: 85 x 4 = 340 lm
 Grados Kelvin: 2.900°
Degrees Kelvin: 2.900°
 Valor cromático / CRI: 85

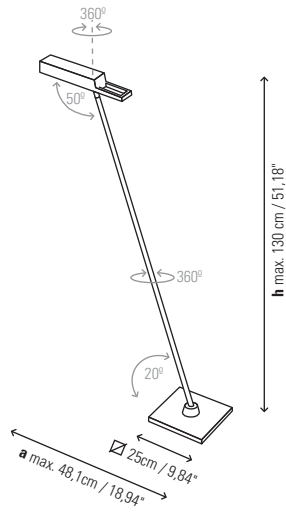

- 3110511L LED CROMO BLANCO / LED CHROME-WHITE
- 3110512L LED CROMO / LED CHROME
- 3110510L LED CROMO-GRAFITO / LED CHROME-GRAPHITE

Pantalla de inyección de zamac orientable
Zamac injected orientable hood
 Base de acero inoxidable / *Stainless steel base*

DIFUSOR / *DIFFUSER*:
 Rotación circular 360° / *Circular rotation 360°*
 Rotación vertical 50° / *Vertical rotation 50°*

MASTIL / *MAST*:
 Rotación circular 360° / *Circular rotation 360°*
 Inclinación mástil 20° / *Mast inclination 20°*

Fotometría disponible / *Photometry available*



FAMÍLIA / FAMILY

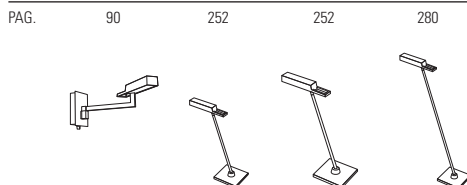

ACABADOS / FINISHING





TAU - PIE

PIE
FLOOR



1 x 42 W Classic P ECO E-27

1 x 11 W E-27

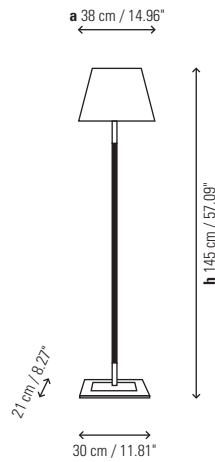

- 3023960 NÍQUEL PIEL OSCURA / NICKEL DARK LEATHER
- 3023961 NÍQUEL PIEL CUERO / NICKEL CAMEL LEATHER
- 3023905 NÍQUEL SATINADO CROMO / SATIN NICKEL-CHROME

BASE INOX / INOX BASE

Acabado: Níquel satinado-Cromo brillante

Finish: Satin nickel-Brilliant chrome

Pantalla rectangular 38 x 25 x 26 cm

Rectangular lampshade 14.96" x 9.84" x 10.24"

- P-480 LINO / LINEN
- P-481 COTONET / COTTON
- P-677 CINTA TRANSLÚCIDA BLANCA / WHITE TRANSLUCENT RIBBON
- P-678 CINTA TRANSLÚCIDA CREMA / CREAM TRANSLUCENT RIBBON

FAMÍLIA / FAMILY

PAG. 180 256 256 282



ACABADOS / FINISHING

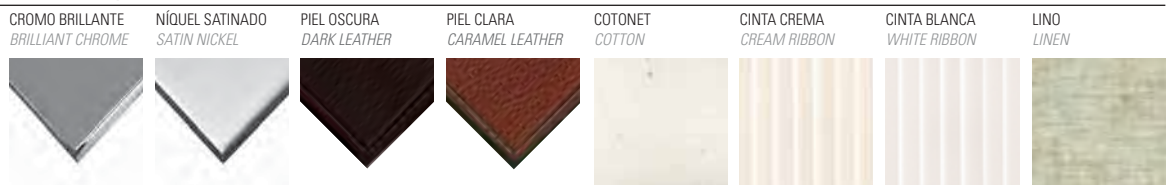



TAU - PIE MADERA

PIE
FLOOR



1 x 42 W Classic P ECO E-27

1 x 11 W E-27

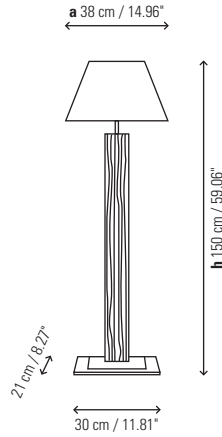

- 3023931 NÍQUEL CEREZO / NICKEL CHERRY
- 3023932 NÍQUEL WENGUÉ / NICKEL WENGUE
- 3023934 NÍQUEL CEBRANO / NICKEL CEBRANO
- 3023901 NÍQUEL BLANCO LACADO / NICKEL WHITE LACQUER

BASE INOX / INOX BASE
Acabado: Níquel satinado–Cromo brillante
Finish: Satin nickel–Brilliant chrome

Pantalla rectangular 38 x 25 x 26 cm
Rectangular lampshade 14.96" x 9.84" x 10.24"

- P-480 LINO / LINEN
- P-481 COTONET / COTTON
- P-542 COTONET BLANCO / WHITE COTTON
- P-677 CINTA TRANSLÚCIDA BLANCA / WHITE TRANSLUCENT RIBBON
- P-678 CINTA TRANSLÚCIDA CREMA / CREAM TRANSLUCENT RIBBON



La madera de cebrano puede sufrir variaciones propias de su naturaleza, no considerándose imperfecciones sus betas o su color. Cada pieza es única por sus propiedades.
Cebrano wood may undergo characteristic variations that are not considered to be imperfections in its grain or colour. Each piece is unique because of its properties.

FAMÍLIA / FAMILY

PAG. 24 24

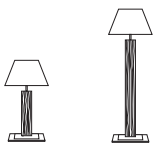

ACABADOS / FINISHING

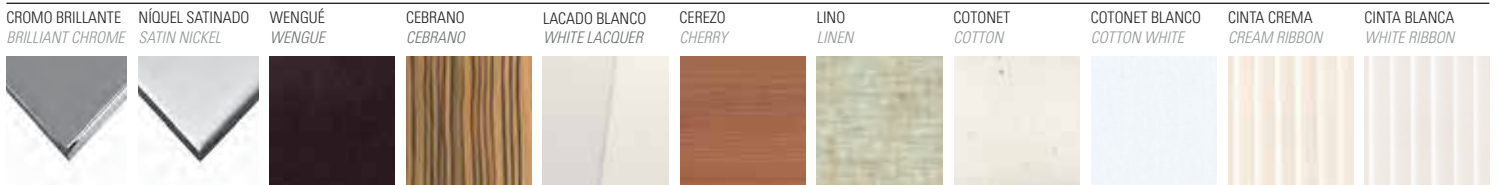



TIMEA - PIE

PIE
FLOOR



1 x 120 W R7S 118 mm

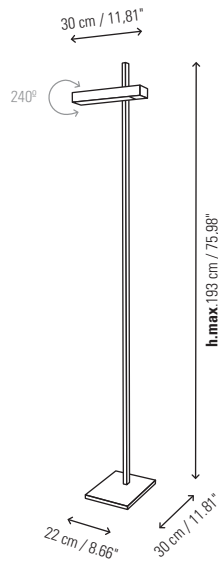

- 3125505 NÍQUEL SATINADO / SATIN NICKEL
- 3125560 NÍQUEL PIEL OSCURA / NICKEL DARK LEATHER
- 3125561 NÍQUEL PIEL CLARA / NICKEL CAMEL LEATHER
- 3125506 CROMO BRILLANTE / BRILLIANT CHROME
- 3125519 CROMO-NEGRO / BLACK-CHROME

- 312550535 NÍQUEL-MADERA / WOOD NICKEL
- 312550635 CROMO-MADERA / WOOD CHROME
- 312551935 CROMO-NEGRO MADERA / WOOD BLACK-CHROME

Lámpara con dimmer incorporado / Lamp with incorporated dimmer
Pantalla inyección de Zamac orientable.

Rotación de giro 240º / 240º orientable Zamac injected hood

Incluye difusor interior cristal / Interior opal glass included

Madera de fresno - color nogal / Ash tree - walnut coloured

Madera wengue para el acabado níquel piel oscura.

Wengue wood for the nickel dark leather finish.

El embellecedor de madera ejerce al mismo tiempo la función de tirador, puesto que al ser de madera nos protege del calor de la bombilla halógena.

The wood decorating detail functions as well as a handle protecting from the halogen lamp temperature.

Versión led disponible próximamente

Led source available. Please consult.



FAMÍLIA / FAMILY

PAG. 92 286

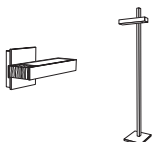

ACABADOS / FINISHING





ARKITEKTURA

20CA
L'INNOVAZIONE
MODERNA
MIA SOSTENIBILE
RINNOVABILI
LA CARA SOSTINE DEL PA

ULMA - PIE

PIE
FLOOR



1 x 70 W Classic A ECO E-27

1 x 18 W E-27

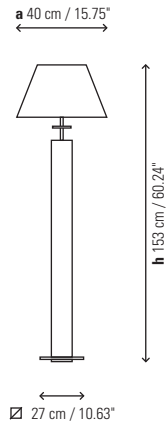

- 3022860 NÍQUEL PIEL OSCURA / *NICKEL DARK LEATHER*
- 3022861 NÍQUEL PIEL CUERO / *NICKEL CARAMEL LEATHER*

Pantalla cuadrada 40 x 28 x 20 cm
Square lampshade 15.75" x 11.02" x 7.87"

- P-110 COTONET / *COTTON*
- P-115 CINTA TRANSLÚCIDA CREMA / *CREAM TRANSLUCENT RIBBON*
- P-116 CINTA TRANSLÚCIDA BLANCA / *WHITE TRANSLUCENT RIBBON*

FAMÍLIA / FAMILY

PAG. 260 288

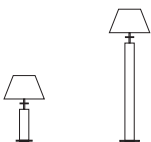

ACABADOS / FINISHING

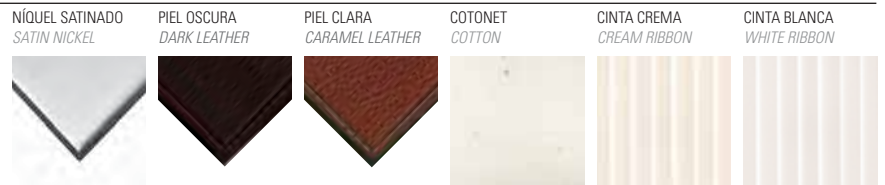





ARTESANAL *HAND-CRAFTING*



AVANI - MINI

APLIQUE
WALL LAMP

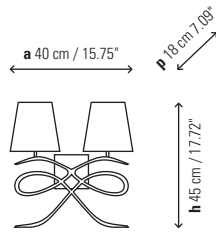
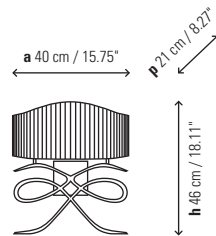

AVANI - GRANDE

APLIQUE
WALL LAMP

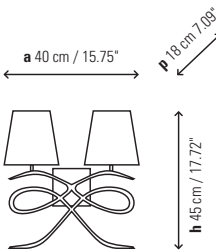
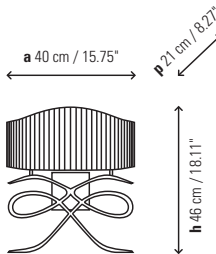

1222003 HIERRO MARRÓN GRAFITO / GRAPHITE BROWN IRON
1222004 HIERRO NEGRO / BLACK IRON

Pantalla 38 x 20 cm
Lampshade 14,96" x 7,87"

P-350 PERGAMINO / PARCHMENT
P-352 COTONET / COTTON
P-354 PLISADA / PLEATED

Pantalla 18 x 15 x 12 cm Precio unitario
Lampshade 7.09" x 5.91" x 4.72" Unitary price

P-100 PERGAMINO / PARCHMENT
P-103 COTONET / COTTON

Fotometría disponible / Photometry available

1222103 HIERRO MARRÓN GRAFITO / GRAPHITE BROWN IRON
1222104 HIERRO NEGRO / BLACK IRON

Pantalla 44,5 x 23 cm
Lampshade CAPELLA 17.52" x 9.06"

P-360 PERGAMINO / PARCHMENT
P-362 COTONET / COTTON
P-364 PLISADA / PLEATED

Pantalla 18 x 18 x 12 cm Precio unitario
Lampshade 7.09" x 7.09" x 4.72" Unitary price

P-370 PERGAMINO / PARCHMENT
P-373 COTONET / COTTON

Fotometría disponible / Photometry available



ACABADOS / FINISHING





FERRARA - 1 LUZ

APLIQUE
WALL LAMP



1 x 42 W Classic P ECO E-27

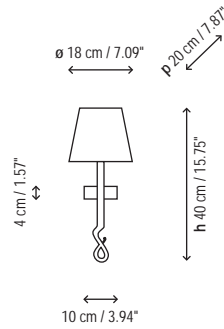

1124204 HIERRO NEGRO / *BLACK IRON*
 1124203 HIERRO MARRÓN GRAFITO / *GRAPHITE BROWN IRON*

Pantalla 18 x 15 x 12 cm / *Lampshade 7.09" x 5.91" x 4.72"*

P-103 COTONET / *COTTON*
 P-098 CINTA TRANSLÚCIDA BLANCA / *WHITE TRANSLUCENT RIBBON*
 P-099 CINTA TRANSLÚCIDA CREMA / *CREAM TRANSLUCENT RIBBON*

FERRARA - 2 LUCES

APLIQUE
WALL LAMP



2 x 42 W Classic P ECO E-27

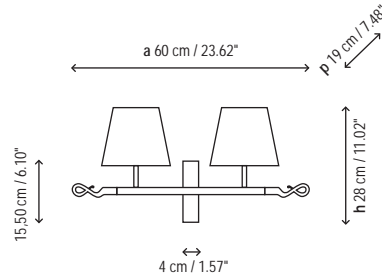

1224204 HIERRO NEGRO / *BLACK IRON*
 1224203 HIERRO MARRÓN GRAFITO / *GRAPHITE BROWN IRON*

Pantalla 18 x 15 x 12 cm / *Lampshade 7.09" x 5.91" x 4.72"*

P-103 COTONET / *COTTON*
 P-098 CINTA TRANSLÚCIDA BLANCA / *WHITE TRANSLUCENT RIBBON*
 P-099 CINTA TRANSLÚCIDA CREMA / *CREAM TRANSLUCENT RIBBON*

FERRARA - 2 LUCES

SUSPENSIÓN
PENDANT LAMP



2 x 70 W Classic A ECO E-27

2 x 18 W E-27

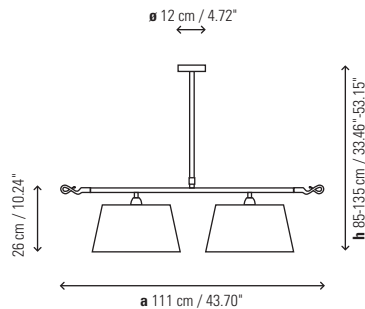

4224204 HIERRO NEGRO / *BLACK IRON*
 4224203 HIERRO MARRÓN GRAFITO / *GRAPHITE BROWN IRON*

Pantalla 38 x 20 x 30 cm / *Lampshade 14.96" x 7.87" x 11.81"*

P-163C COTONET / *COTTON*
 P-167C CINTA TRANSLÚCIDA CREMA / *CREAM TRANSLUCENT RIBBON*
 P-168C CINTA TRANSLÚCIDA BLANCA / *WHITE TRANSLUCENT RIBBON*

Pantalla con difusor superior / *The shade includes upper diffuser*

FAMILIA / FAMILY

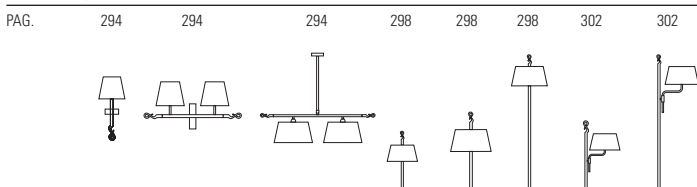

ACABADOS / FINISHING

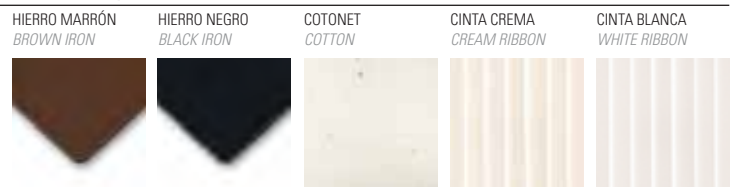

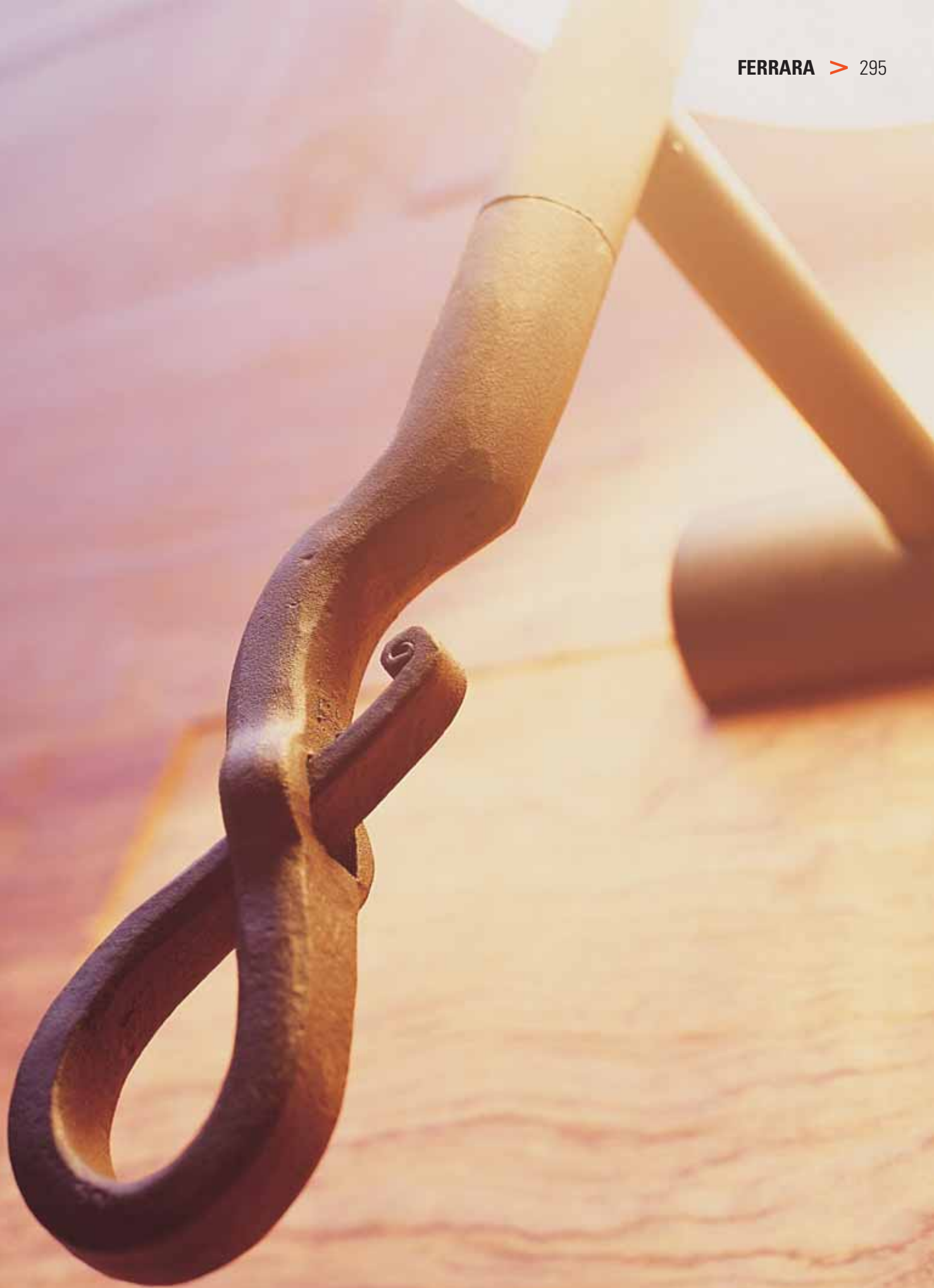





FERRARA - MINI

MESITA
BEDSIDE



2 x 42 W Classic P ECO E-27



- 2124204 HIERRO NEGRO / *BLACK IRON*
- 2124203 HIERRO MARRÓN GRAFITO / *GRAPHITE BROWN IRON*

Pantalla 32 x 17 x 25 cm / *Lampshade 12.60" x 6.69" x 9.84"*

- P-445 CINTA TRANSLÚCIDA CREMA / *CREAM TRANSLUCENT RIBBON*
- P-446 CINTA TRANSLÚCIDA BLANCA / *WHITE TRANSLUCENT RIBBON*
- P-447 COTONET / *COTTON*

Pantalla con difusor superior metacrilato
Shade includes methacrylate upper diffuser

FERRARA - MESA

MESA
TABLE



2 x 42 W Classic P ECO E-27

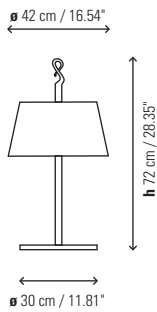

- 2224204 HIERRO NEGRO / *BLACK IRON*
- 2224203 HIERRO MARRÓN GRAFITO / *GRAPHITE BROWN IRON*

Pantalla 42 x 23 x 33 cm / *Lampshade 16.54" x 9.06" x 12.99"*

- P-435 COTONET / *COTTON*
- P-442 CINTA TRANSLÚCIDA BLANCA / *WHITE TRANSLUCENT RIBBON*
- P-443 CINTA TRANSLÚCIDA CREMA / *CREAM TRANSLUCENT RIBBON*

Pantalla con difusor superior metacrilato
Shade includes methacrylate upper diffuser

FERRARA - PIE

PIE
FLOOR



2 x 42 W Classic P ECO E-27



- 3024204 HIERRO NEGRO / *BLACK IRON*
- 3024203 HIERRO MARRÓN GRAFITO / *GRAPHITE BROWN IRON*

Pantalla 42 x 23 x 33 cm / *Lampshade 16.54" x 9.06" x 12.99"*

- P-435 COTONET / *COTTON*
- P-442 CINTA TRANSLÚCIDA BLANCA / *WHITE TRANSLUCENT RIBBON*
- P-443 CINTA TRANSLÚCIDA CREMA / *CREAM TRANSLUCENT RIBBON*

Pantalla con difusor superior metacrilato
Shade includes methacrylate upper diffuser

FAMÍLIA / FAMILY

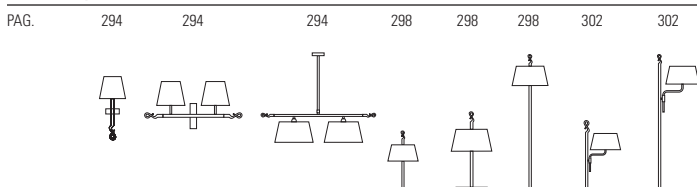

ACABADOS / FINISHING

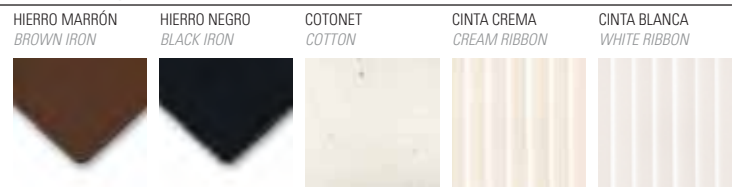







FERRARA - MESA MÓVIL

ESCRITORIO
DESK LAMP



1 x 42 W Classic P ECO E-27

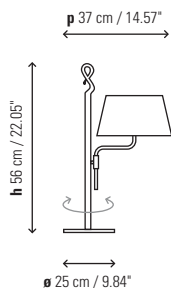

1924204 HIERRO NEGRO / *BLACK IRON*
1924203 HIERRO MARRÓN GRAFITO / *GRAPHITE BROWN IRON*

Pantalla 22 x 13 x 16 cm / *Lampshade 8.66" x 5.12" x 6.30"*

P-409 COTONET / *COTTON*
P-407 CINTA TRANSLÚCIDA BLANCA / *WHITE TRANSLUCENT RIBBON*
P-408 CINTA TRANSLÚCIDA CREMA / *CREAM TRANSLUCENT RIBBON*

Brazo móvil / *Swivel arm*

FERRARA - PIE MÓVIL

PIE
FLOOR



1 x 42 W Classic P ECO E-27

1 x 11 W E-27

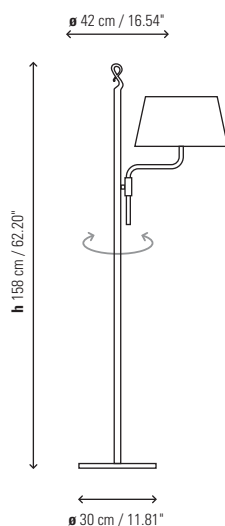

3124204 HIERRO NEGRO / *BLACK IRON*
3124203 HIERRO MARRÓN GRAFITO / *GRAPHITE BROWN IRON*

Pantalla 33 x 18 x 25 cm / *Lampshade 12.99" x 7.09" x 9.84"*

P-148 CINTA TRANSLÚCIDA BLANCA / *WHITE TRANSLUCENT RIBBON*
P-157 CINTA TRANSLÚCIDA CREMA / *CREAM TRANSLUCENT RIBBON*
P-159 COTONET / *COTTON*

Brazo móvil / *Swivel arm*

FAMÍLIA / FAMILY

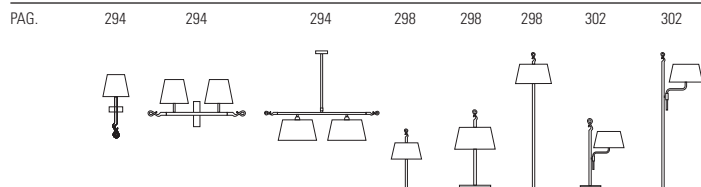

ACABADOS / FINISHING

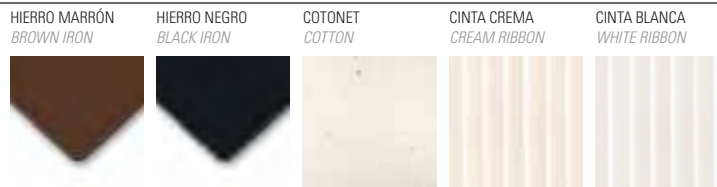







TOUS - 3 LUCES

SUSPENSIÓN
PENDANT LAMP



3 x 42 W Classic P ECO E-27

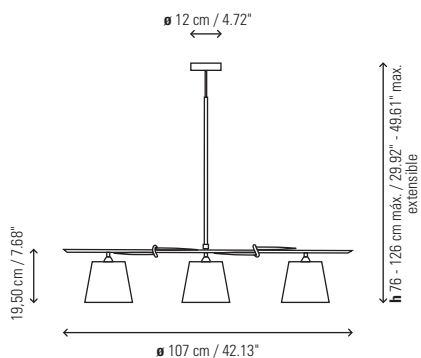

4323404 HIERRO NEGRO / BLACK IRON
4323403 HIERRO MARRÓN GRAFITO / GRAPHITE BROWN IRON

Pantalla 18 x 15 x 12 cm / Lampshade 7.09" x 5.91" x 4.72"

P-100C PERGAMINO / PARCHMENT
P-103C COTONET / COTTON

TOUS - MESA

MESA
TABLE



1 x 42 W Classic P ECO E-27

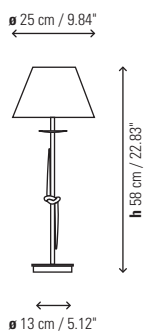

2123404 HIERRO NEGRO / BLACK IRON
2123403 HIERRO MARRÓN GRAFITO / GRAPHITE BROWN IRON

Pantalla 25 x 16 x 12 cm / Lampshade 9.84" x 6.30" x 4.72"

P-380 PERGAMINO / PARCHMENT
P-383 COTONET / COTTON

TOUS - PIE

PIE
FLOOR



1 x 70 W Classic A ECO E-27

1 x 18 W E-27

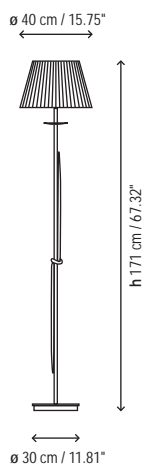

3023404 HIERRO NEGRO / BLACK IRON
3023403 HIERRO MARRÓN GRAFITO / GRAPHITE BROWN IRON

Pantalla 40 x 26 x 25 cm / Lampshade 15.75" x 10.24" x 9.84"

P-270 PERGAMINO / PARCHMENT
P-273 COTONET / COTTON

ACABADOS / FINISHING







MESAS AUXILIARES

TABLES



PEANA - 01 FONDA EUROPA

PEANA LUMINOSA
TABLE LIGHT



1 x 70 W Classic A ECO E-27

1 x 30 W E-27

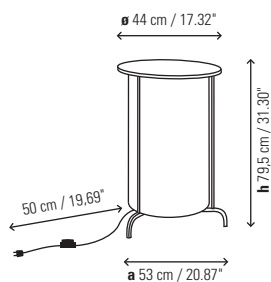

- 0124702 LATÓN - LACADO BLANCO / BRASS - WHITE LACQUER
- 0124707 LATÓN PULIDO - MADERA NATURAL
POLISHED BRASS - NATURAL WOOD
- 0124706 LATÓN PULIDO - MADERA WENGUÉ
POLISHED BRASS - WENGUE WOOD
- 0124701 CROMO - LACADO BLANCO / CHROME - WHITE LACQUER
- 0124705 CROMO - MADERA NATURAL / CHROME - NATURAL WOOD
- 0124704 CROMO - MADERA WENGUÉ / CHROME - WENGUE WOOD

Pantalla 30 x 66 cm / Lampshade 11.81" x 25.98"

P-519 COTONET BLANCO / WHITE COTTON

PEANA - 02 FONDA EUROPA

PEANA LUMINOSA
TABLE LIGHT



1 x 70 W Classic A ECO E-27

1 x 30 W E-27

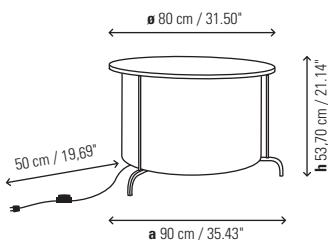

- 0224702 LATÓN - LACADO BLANCO / BRASS - WHITE LACQUER
- 0224707 LATÓN PULIDO - MADERA NATURAL
POLISHED BRASS - NATURAL WOOD
- 0224706 LATÓN PULIDO - MADERA WENGUÉ
POLISHED BRASS - WENGUE WOOD
- 0224701 CROMO - LACADO BLANCO / CHROME - WHITE LACQUER
- 0224705 CROMO - MADERA NATURAL / CHROME - NATURAL WOOD
- 0224704 CROMO - MADERA WENGUÉ / CHROME - WENGUE WOOD

Pantalla 44 x 68 cm / Lampshade 17.32" x 26.77"

P-540 COTONET BLANCO / WHITE COTTON

PEANA - 03 FONDA EUROPA

PEANA LUMINOSA
TABLE LIGHT



1 x 70 W Classic A ECO E-27

1 x 30 W E-27

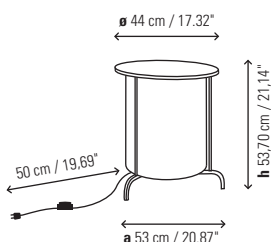

- 0324702 LATÓN - LACADO BLANCO / BRASS - WHITE LACQUER
- 0324707 LATÓN PULIDO - MADERA NATURAL
POLISHED BRASS - NATURAL WOOD
- 0324706 LATÓN PULIDO - MADERA WENGUÉ
POLISHED BRASS - WENGUE WOOD
- 0324701 CROMO - LACADO BLANCO / CHROME - WHITE LACQUER
- 0324705 CROMO - MADERA NATURAL / CHROME - NATURAL WOOD
- 0324704 CROMO - MADERA WENGUÉ / CHROME - WENGUE WOOD

Pantalla 30 x 40 cm / Lampshade 11.81" x 15.75"

P-543 COTONET BLANCO / WHITE COTTON

ACABADOS / FINISHING

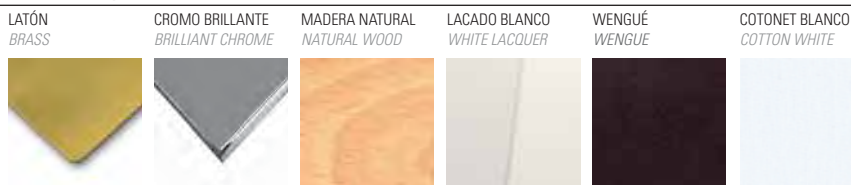







"Peana Lluminosa"

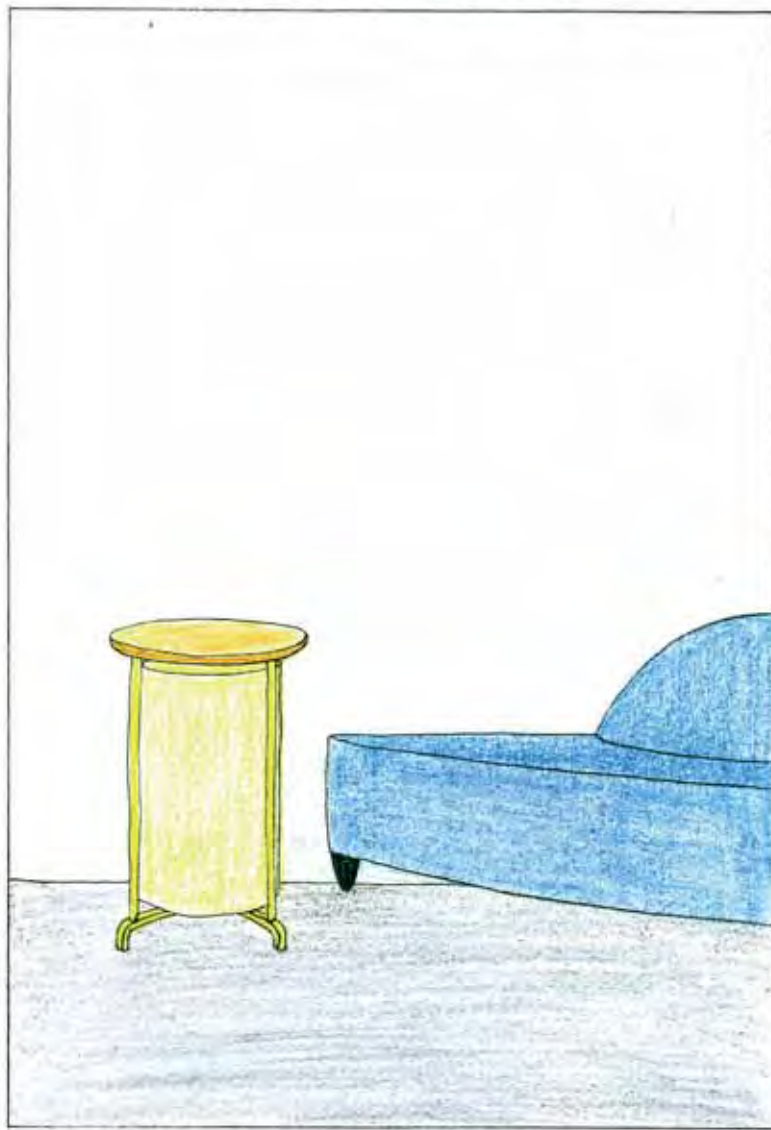

C. Riart
Març - 2005



BANE - 30

MESA AUXILIAR
OCCASIONAL TABLE

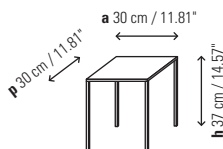

- MB03030 BANE 30 MESA ROBLE NATURAL / NATURAL OAK
- MB03031 BANE 30 MESA CEREZO / CHERRY
- MB03032 BANE 30 MESA WENGUÉ / WENGUE
- MB03034 BANE 30 MESA CEBRANO / CEBRANO
- MB03060 BANE 30 MESA PIEL OSCURA / DARK LEATHER
- MB03061 BANE 30 MESA PIEL CUERO / CAMEL LEATHER
- MB03062 BANE 30 MESA BLANCA / WHITE LACQUER

BANE - 40

MESA AUXILIAR
OCCASIONAL TABLE

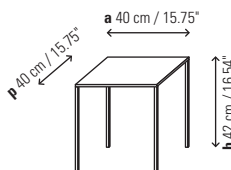

- MB04030 BANE 40 MESA ROBLE NATURAL / NATURAL OAK
- MB04031 BANE 40 MESA CEREZO / CHERRY
- MB04032 BANE 40 MESA WENGUÉ / WENGUE
- MB04034 BANE 40 MESA CEBRANO / CEBRANO
- MB04060 BANE 40 MESA PIEL OSCURA / DARK LEATHER
- MB04061 BANE 40 MESA PIEL CUERO / CAMEL LEATHER
- MB04062 BANE 40 MESA BLANCA / WHITE LACQUER

BANE - 50

MESA AUXILIAR
OCCASIONAL TABLE

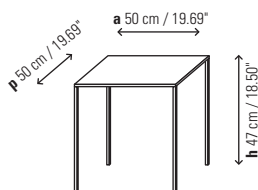

- MB05030 BANE 50 MESA ROBLE NATURAL / NATURAL OAK
- MB05031 BANE 50 MESA CEREZO / CHERRY
- MB05032 BANE 50 MESA WENGUÉ / WENGUE
- MB05034 BANE 50 MESA CEBRANO / CEBRANO
- MB05060 BANE 50 MESA PIEL OSCURA / DARK LEATHER
- MB05061 BANE 50 MESA PIEL CUERO / CAMEL LEATHER
- MB05062 BANE 50 MESA BLANCA / WHITE LACQUER

**BANE - 60
CON TRAVESERO**

MESA AUXILIAR
OCCASIONAL TABLE

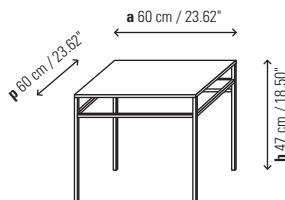

- TR06030 BANE 60 MESA ROBLE NATURAL / NATURAL OAK
- TR06031 BANE 60 MESA CEREZO / CHERRY
- TR06032 BANE 60 MESA WENGUÉ / WENGUE
- TR06034 BANE 60 MESA CEBRANO / CEBRANO
- TR06060 BANE 60 MESA PIEL OSCURA / DARK LEATHER
- TR06061 BANE 60 MESA PIEL CUERO / CAMEL LEATHER
- TR06062 BANE 60 MESA BLANCA / WHITE LACQUER

**BANE - 60
SIN TRAVESERO**

MESA AUXILIAR
OCCASIONAL TABLE

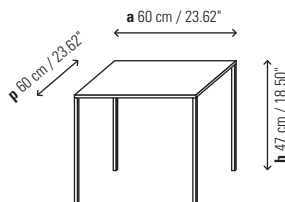

- ST06030 BANE 60 MESA ROBLE NATURAL / NATURAL OAK
- ST06031 BANE 60 MESA CEREZO / CHERRY
- ST06032 BANE 60 MESA WENGUÉ / WENGUE
- ST06034 BANE 60 MESA CEBRANO / CEBRANO
- ST06060 BANE 60 MESA PIEL OSCURA / DARK LEATHER
- ST06061 BANE 60 MESA PIEL CUERO / CAMEL LEATHER
- ST06062 BANE 60 MESA BLANCA / WHITE LACQUER

Estructura níquel satinado-Sobre de piel
Satin nickel structure-Leather
Estructura cromo-Sobre lacado blanco
Chrome structure-White lacquer

ACABADOS / FINISHING

