

# AMEZ ZEUS

 HFS GROUP  
www.hfs-group.com

KYLIA

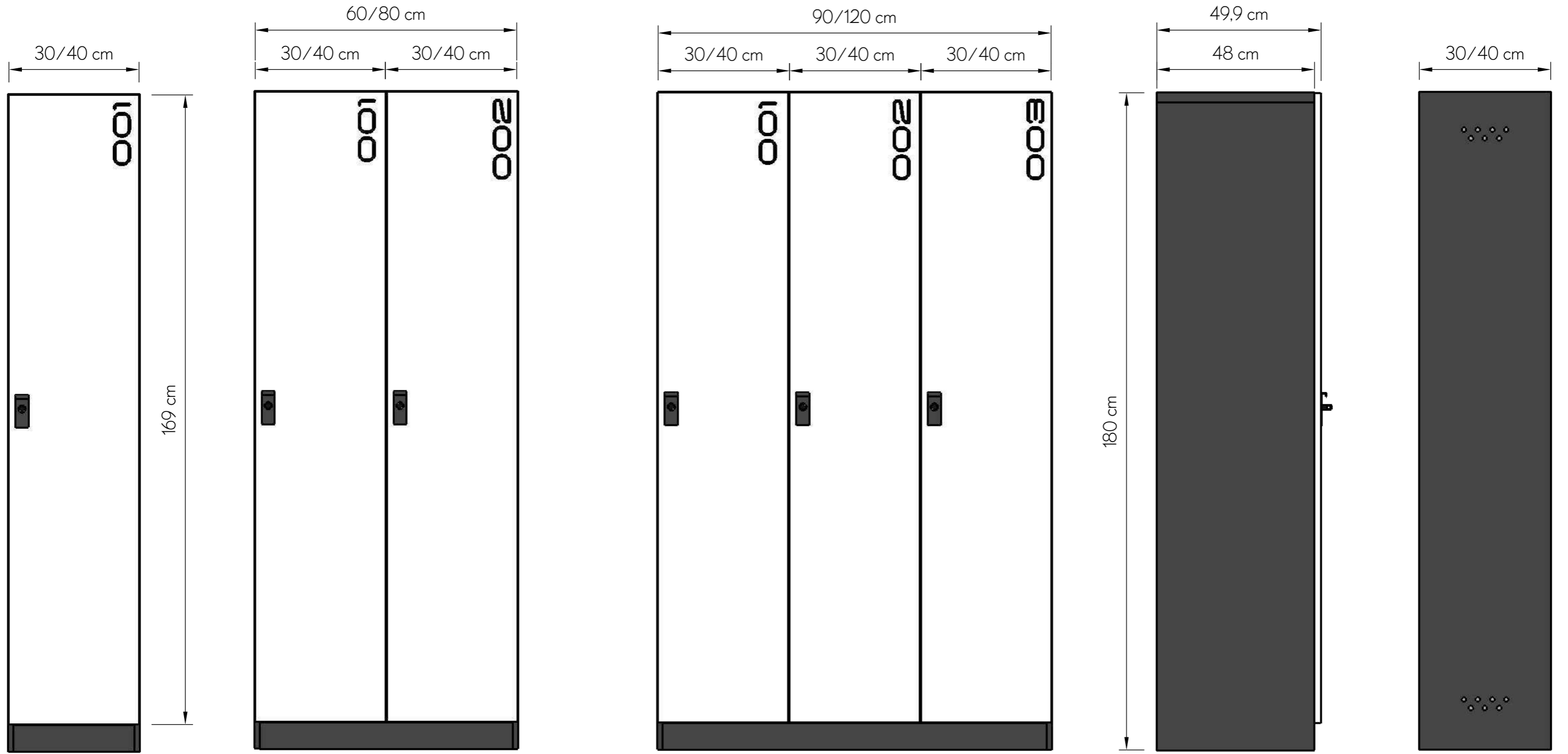



A1

A2

A3

SIDE VIEW

BACK VIEW  
VENTILATION



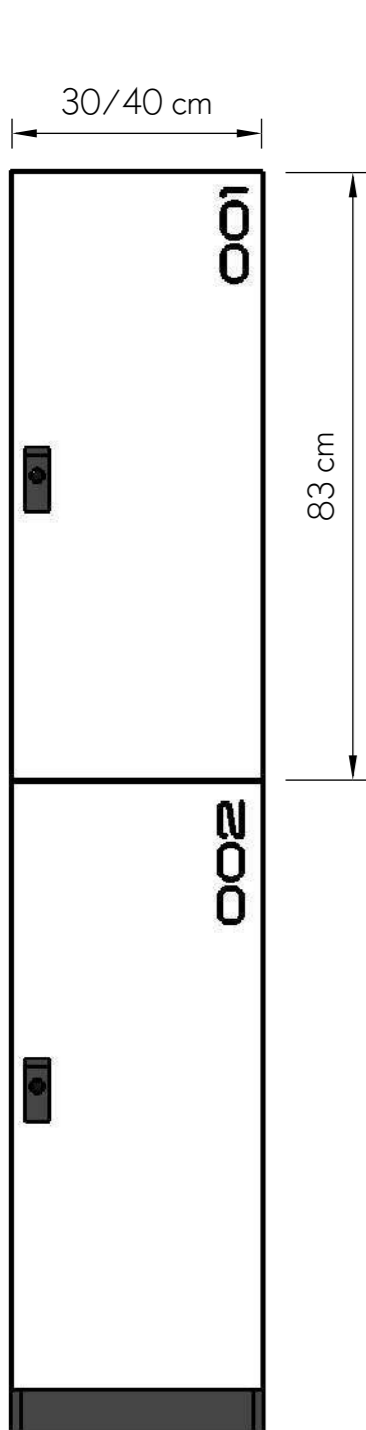

B2

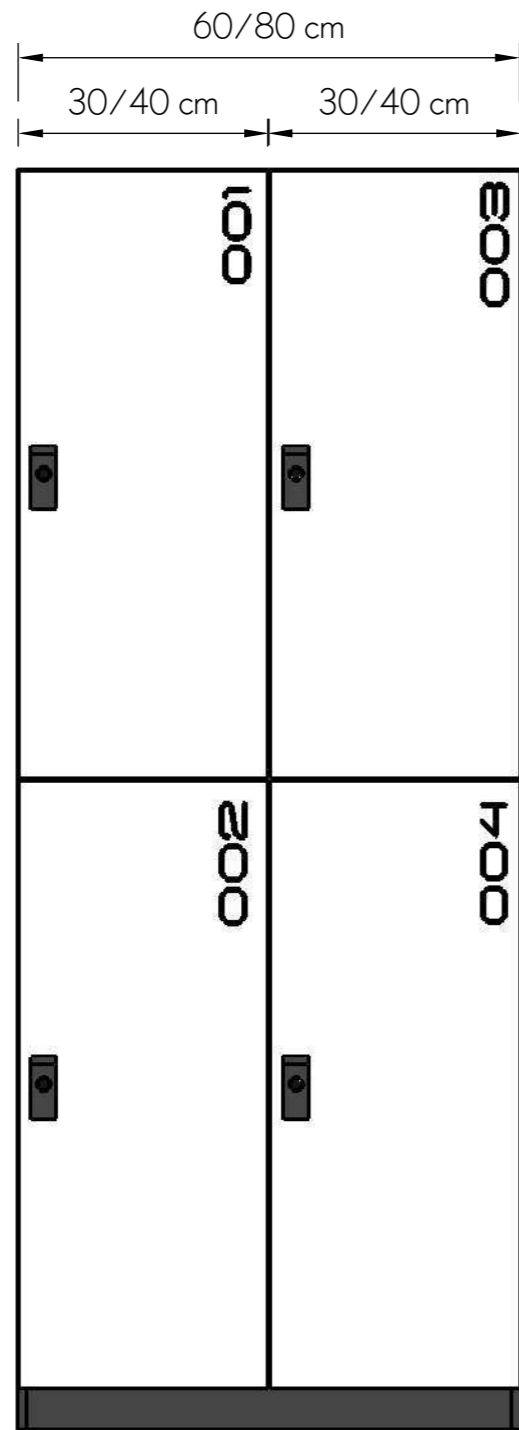

B4

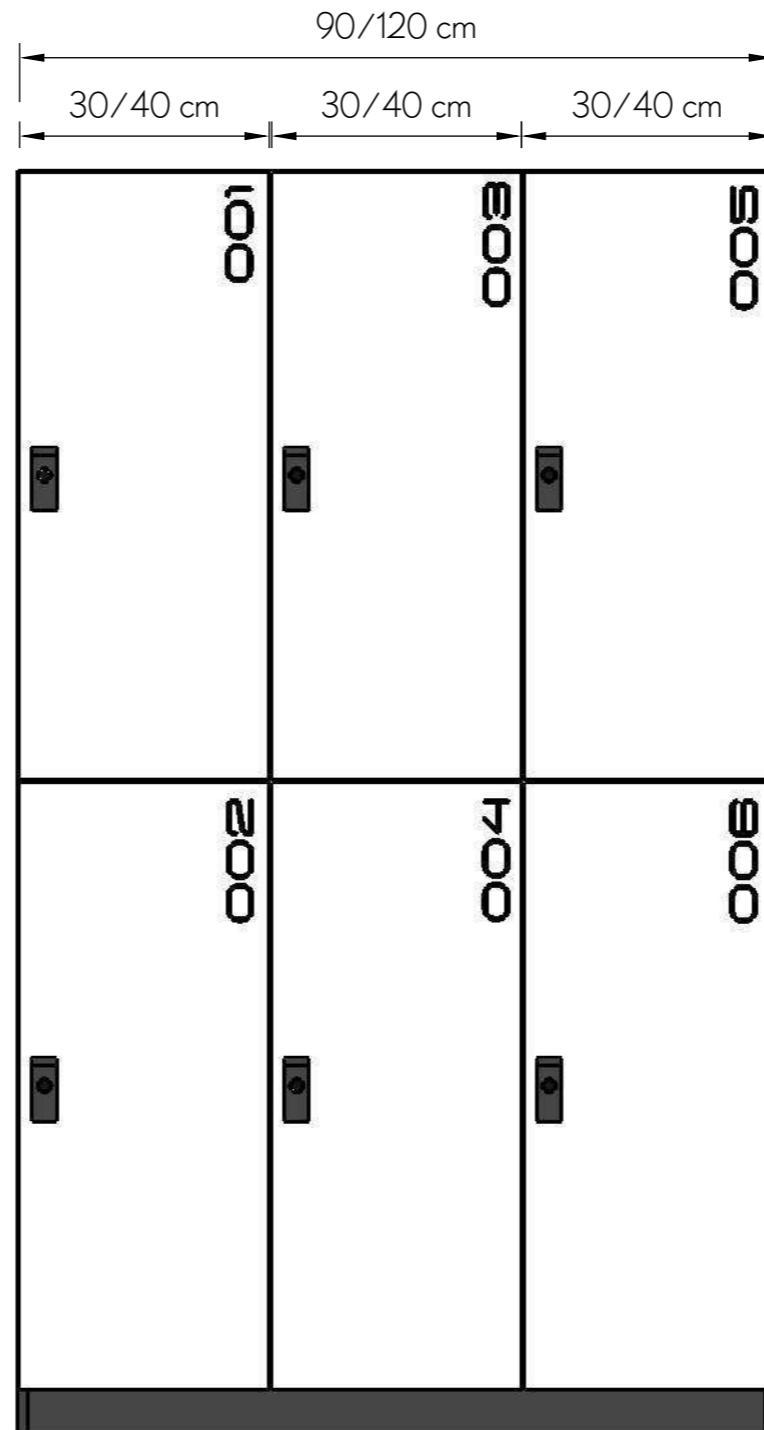

B6

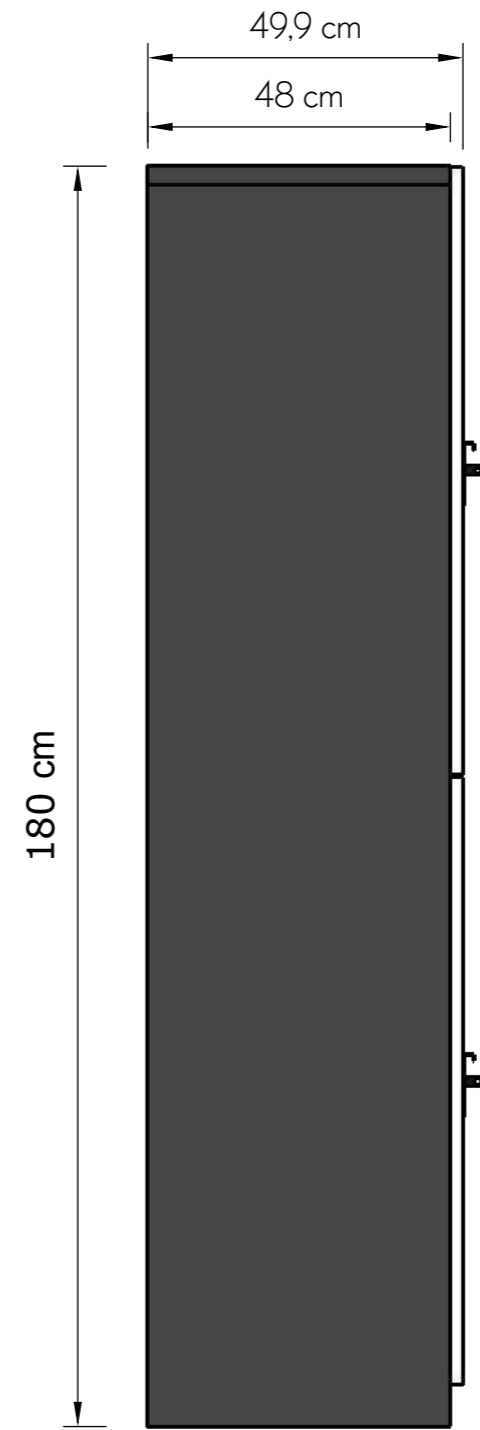

SIDE VIEW

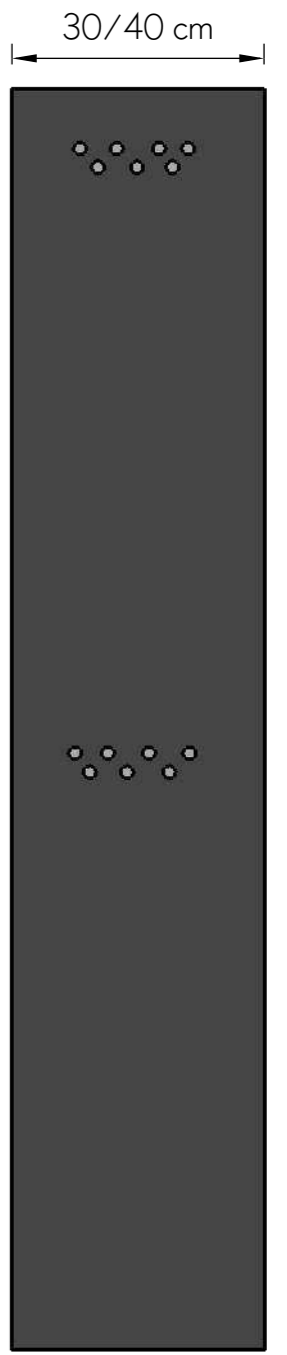

BACK VIEW  
VENTILATION

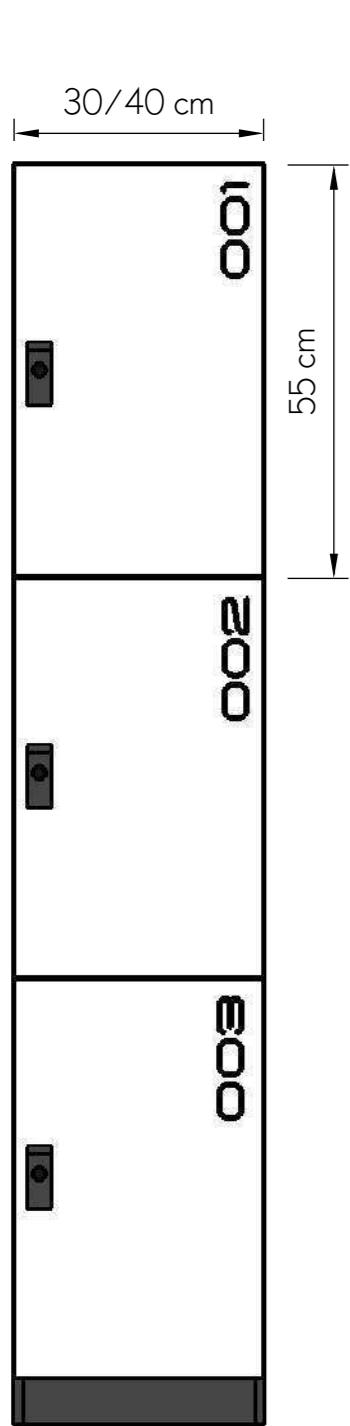

C3

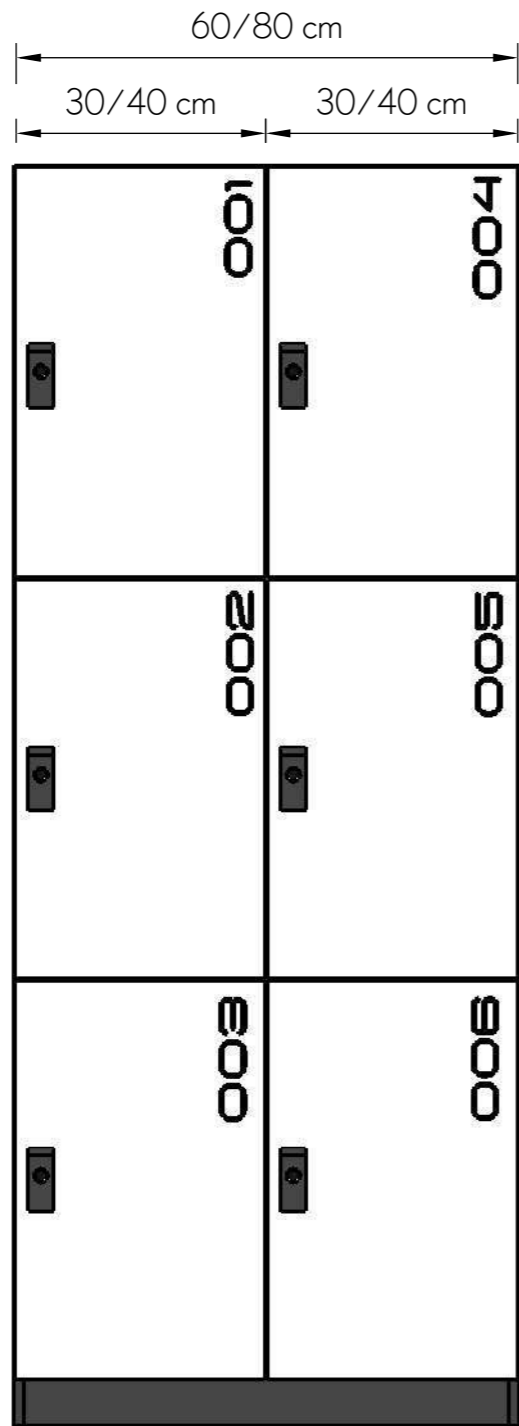

C6

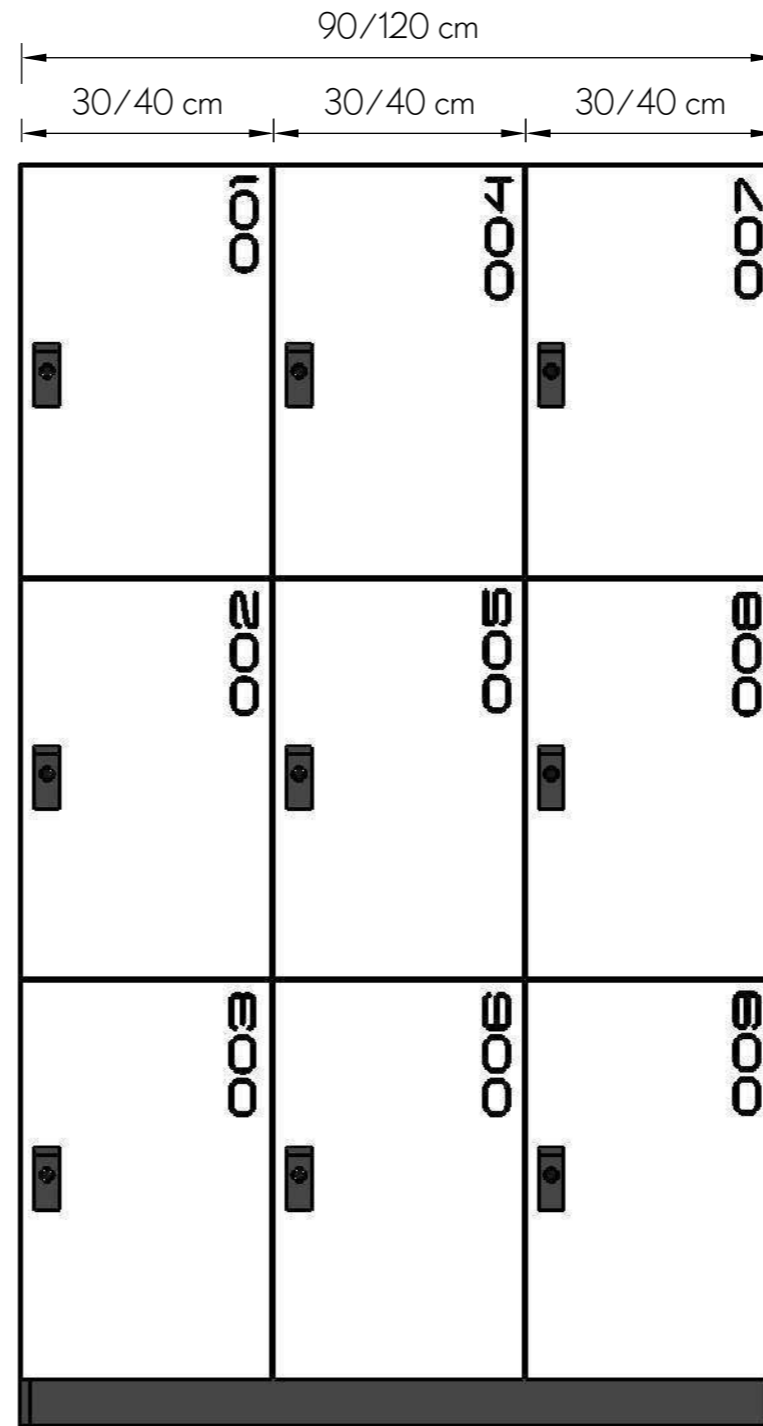

C9

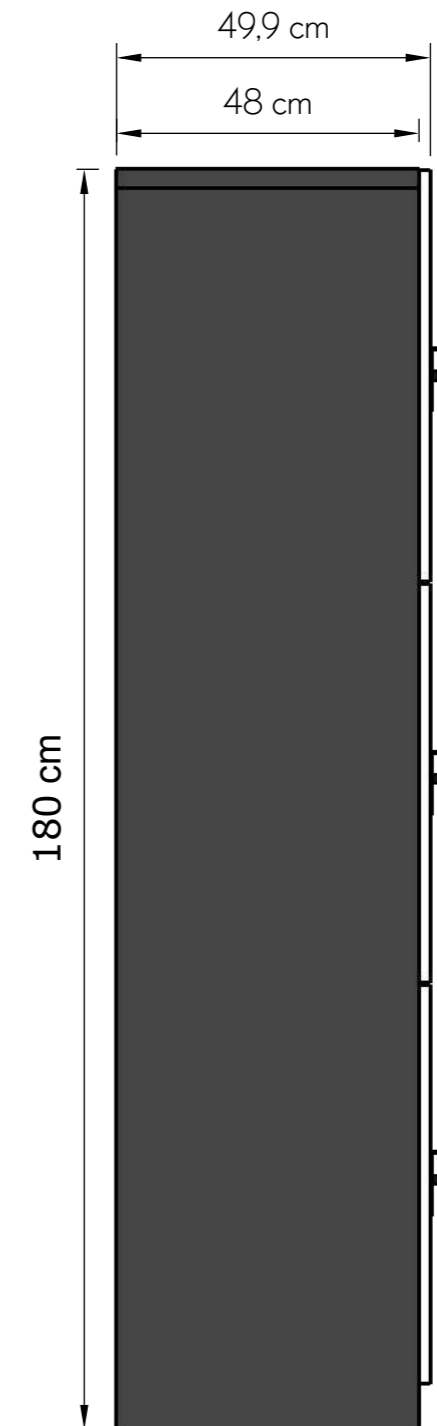

SIDE VIEW

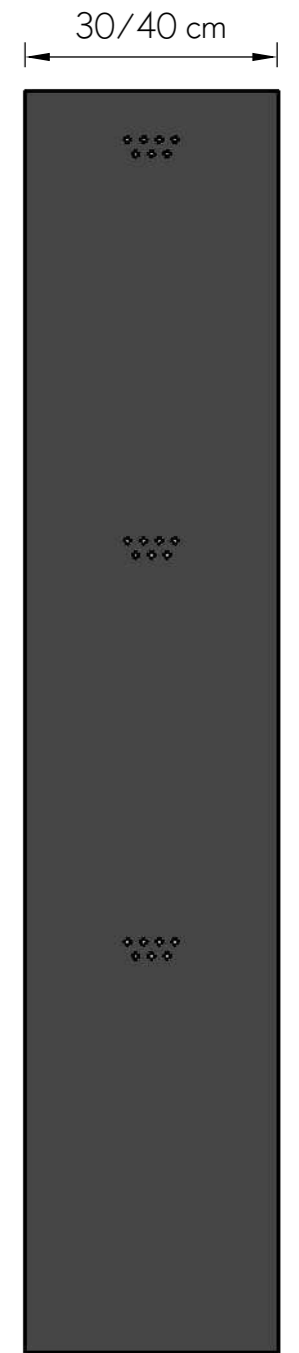

BACK VIEW  
VENTILATION

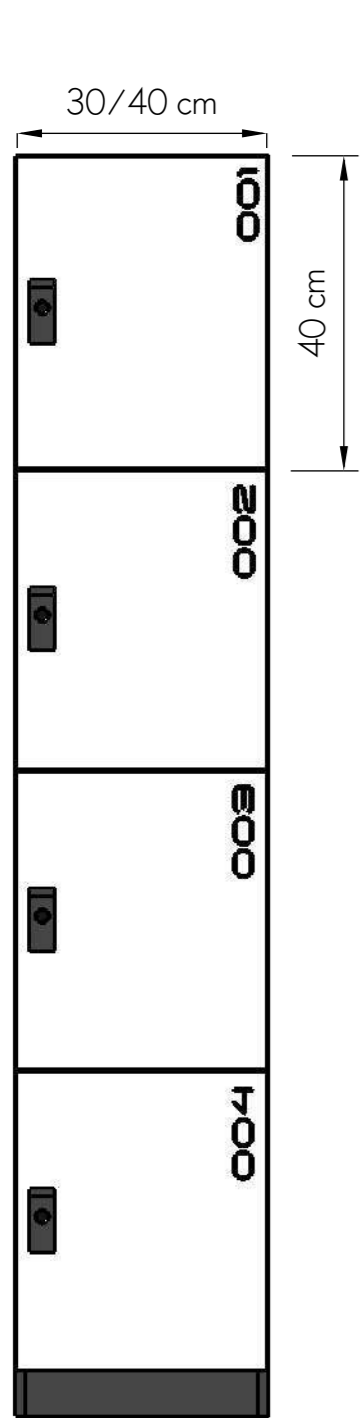

D4

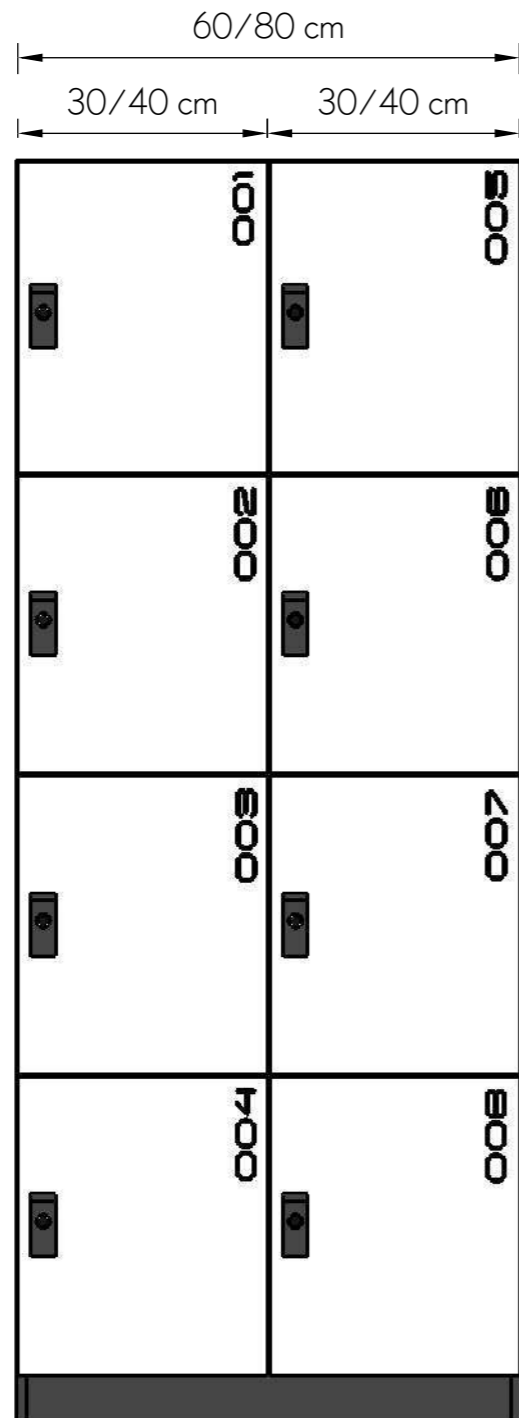

D8

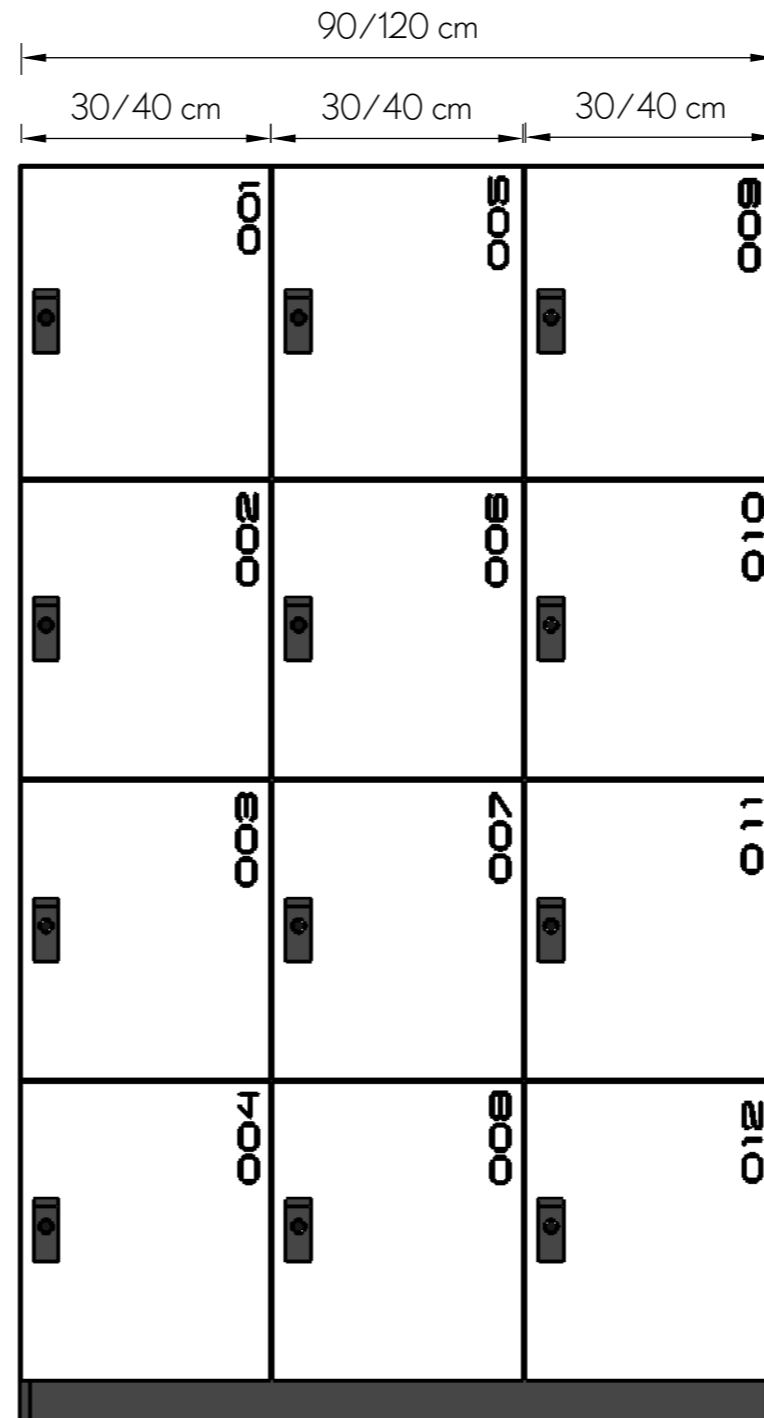

D12

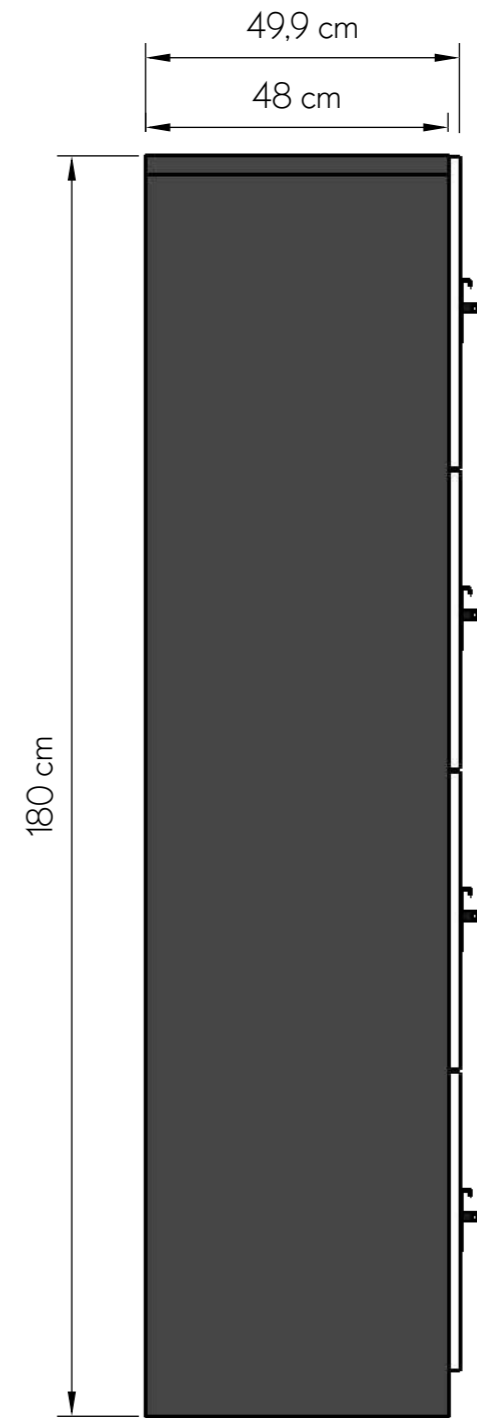

SIDE VIEW

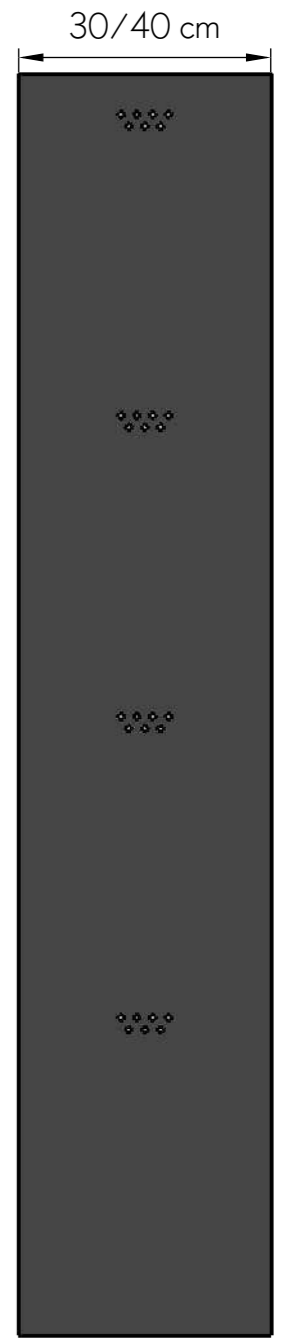

BACK VIEW  
VENTILATION

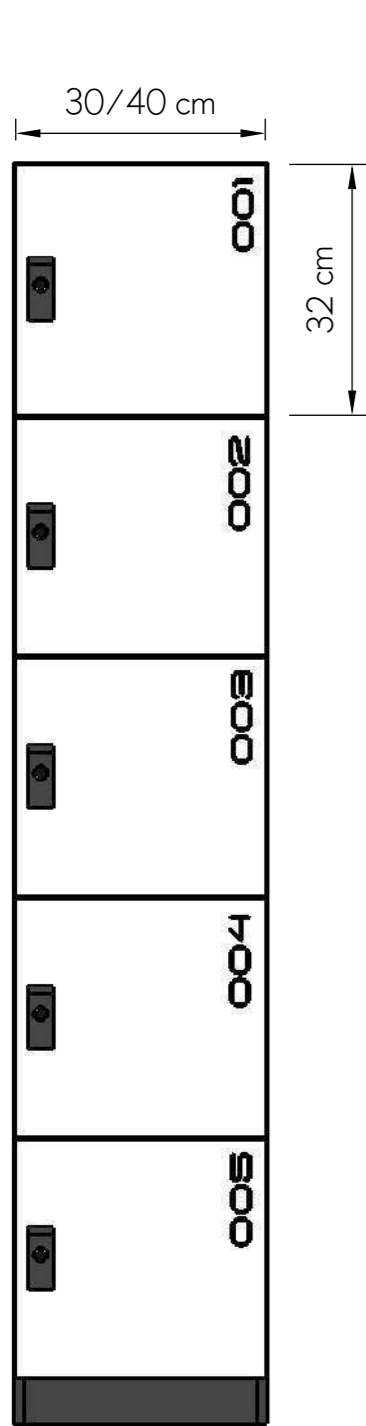

E5

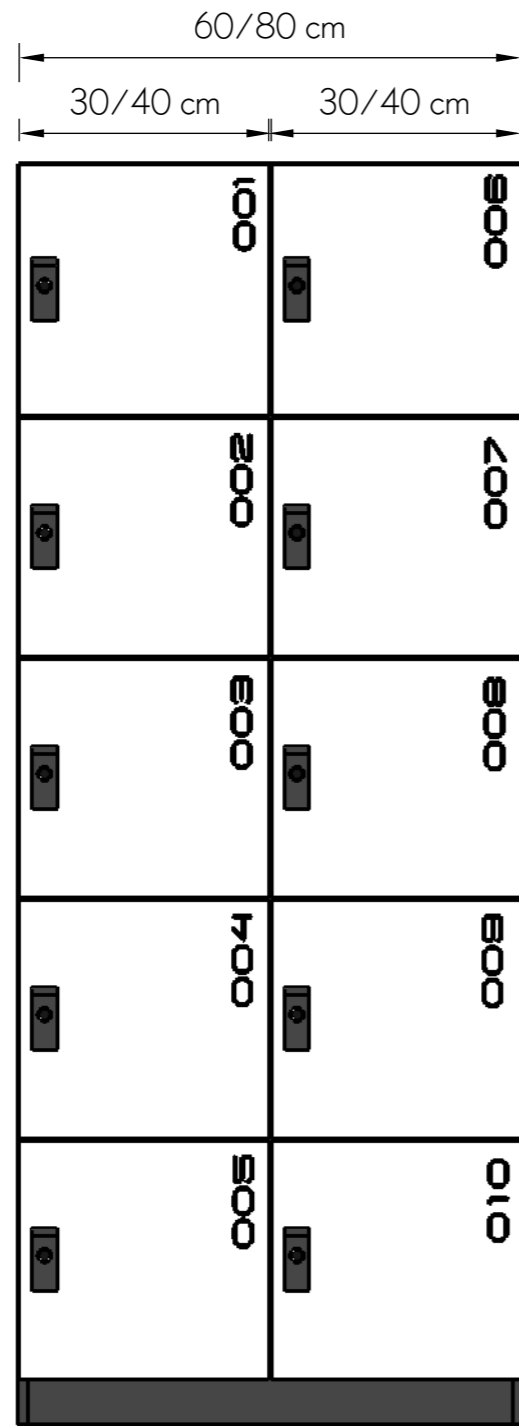

E10

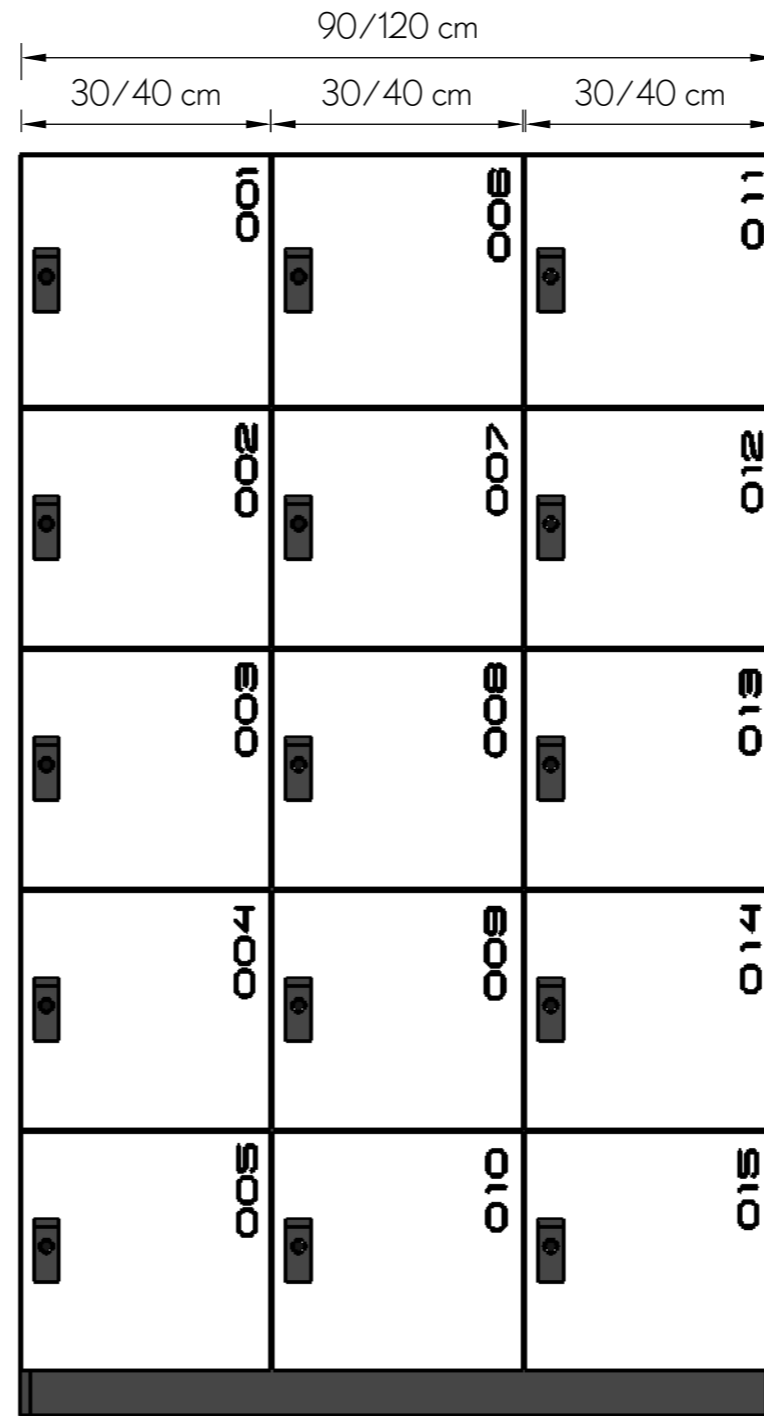

E15

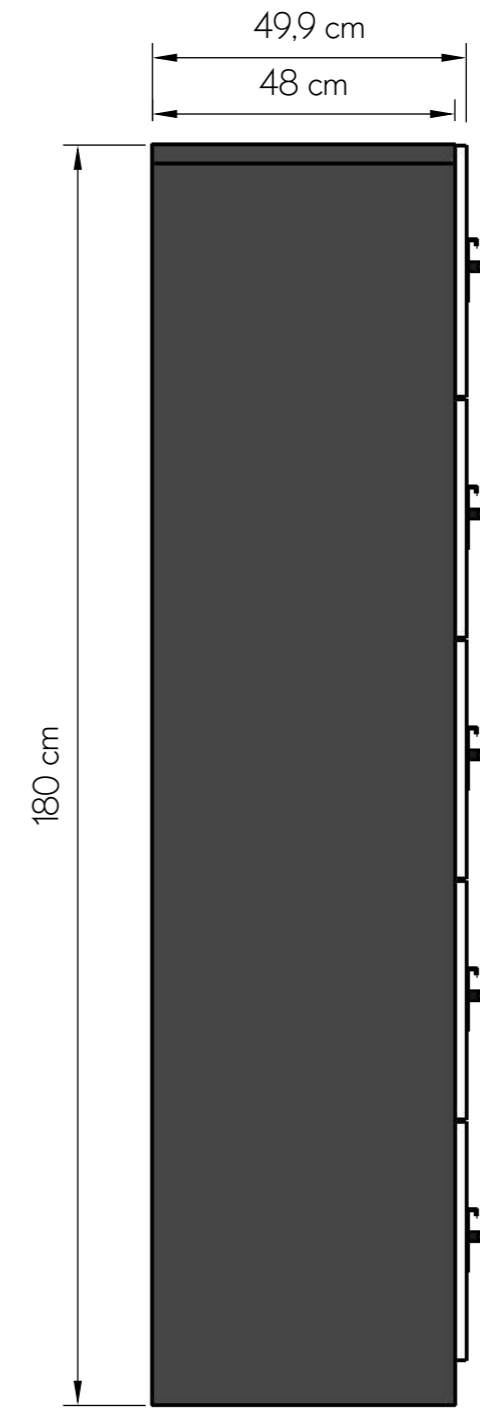

SIDE VIEW

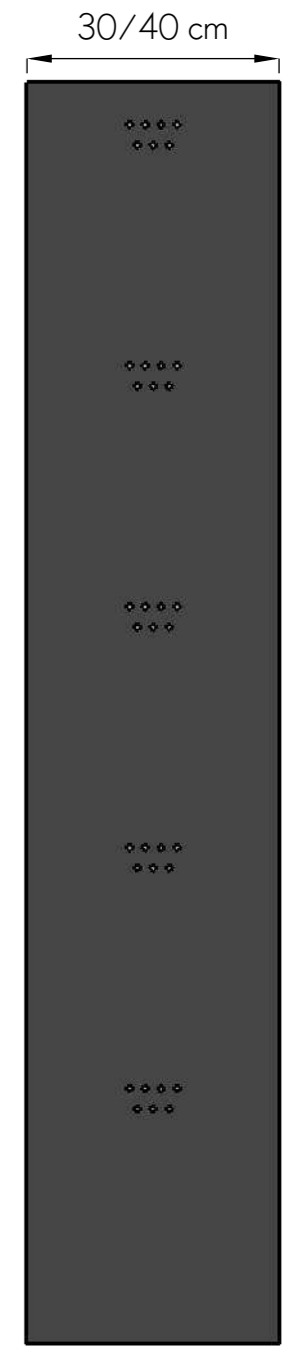

BACK VIEW  
VENTILATION



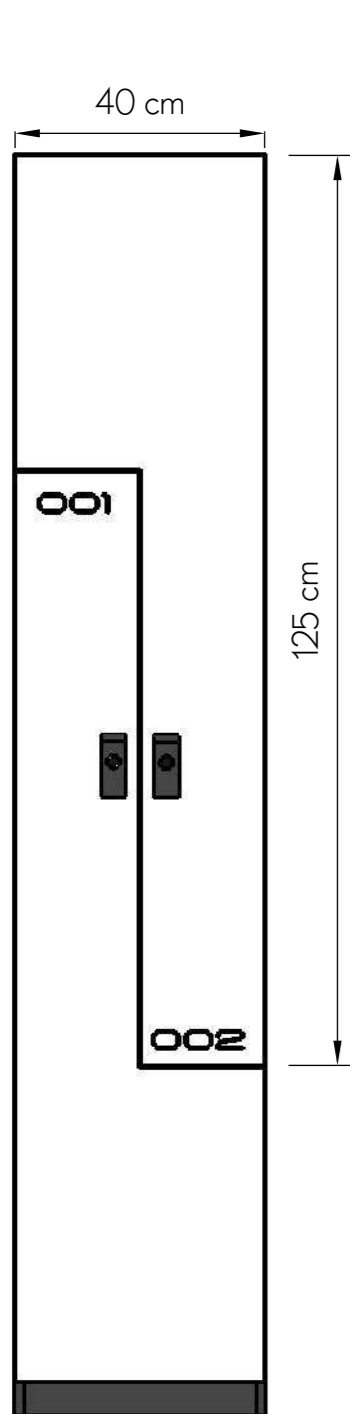

L2

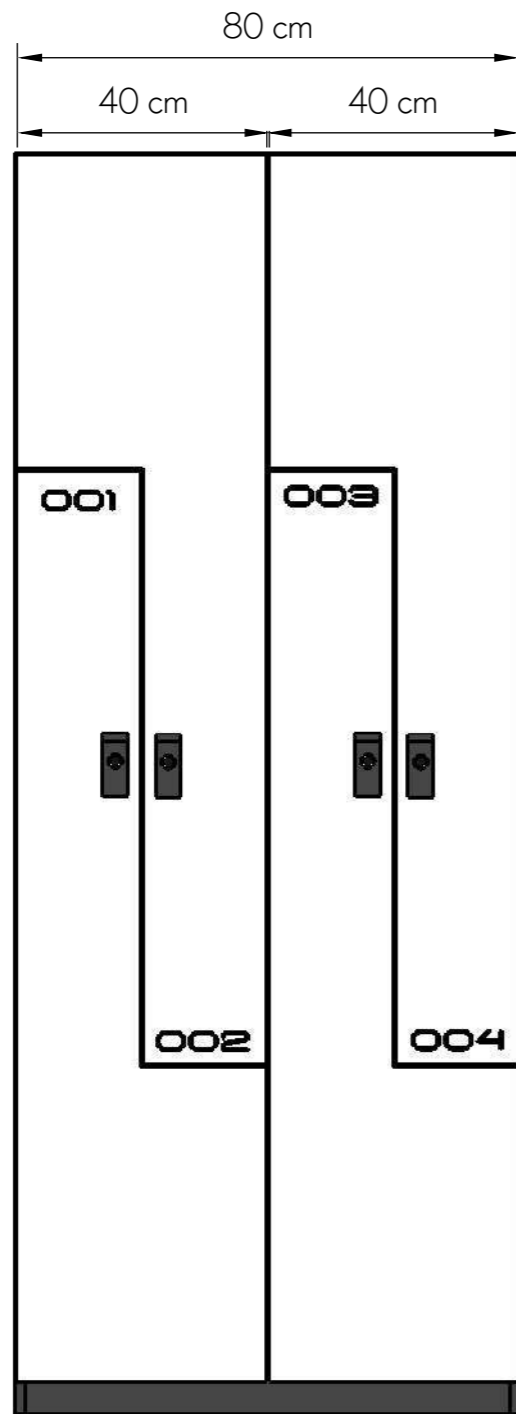

L4

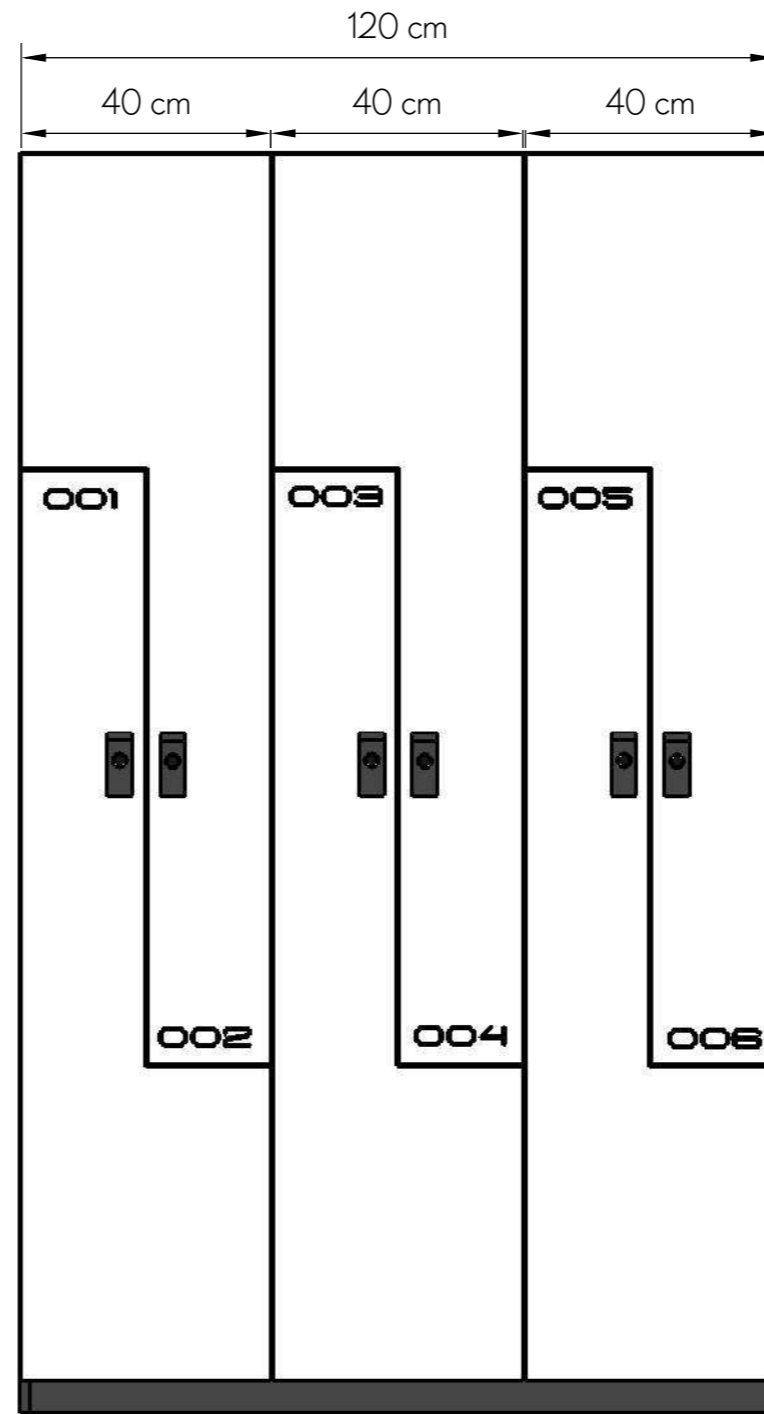

L6

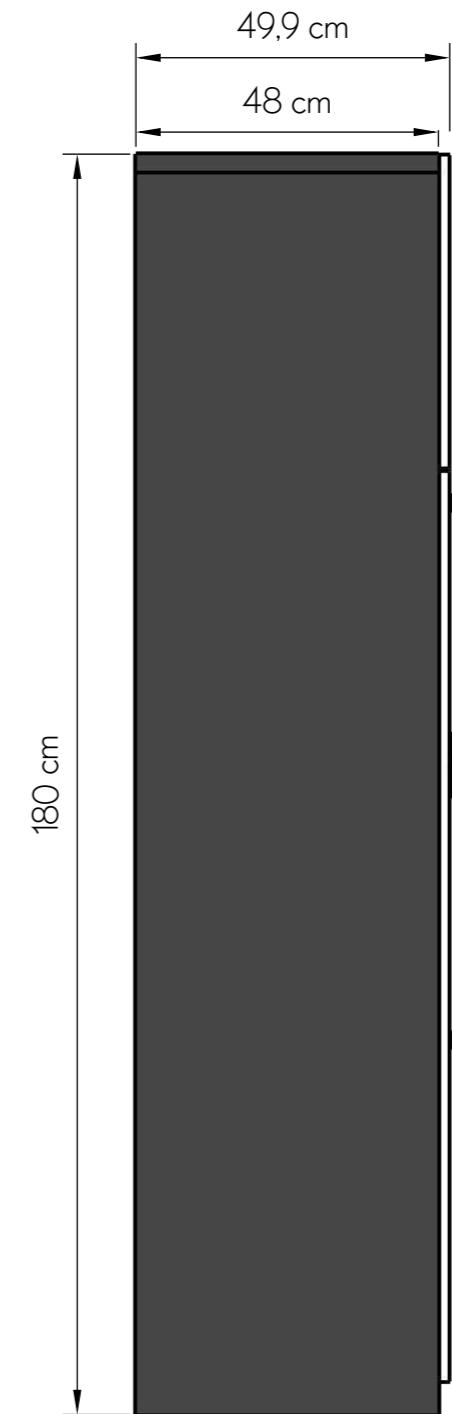

SIDE VIEW

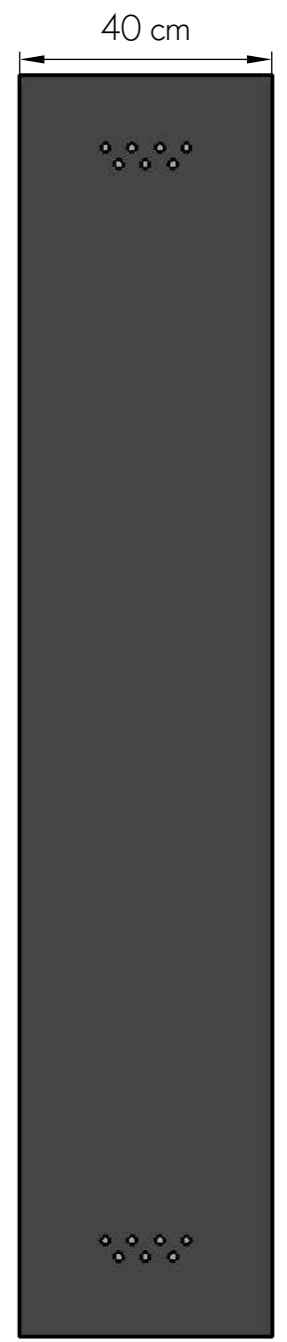

BACK VIEW  
VENTILATION

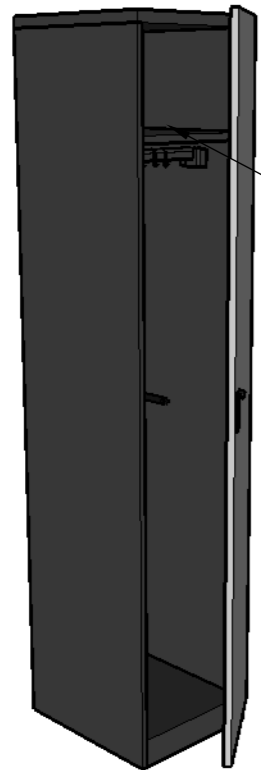

\* SHELF  
\* RAIL

MODEL A  
\*ADDITIONAL SHELF  
\*RAIL WITH 3 HOOKS

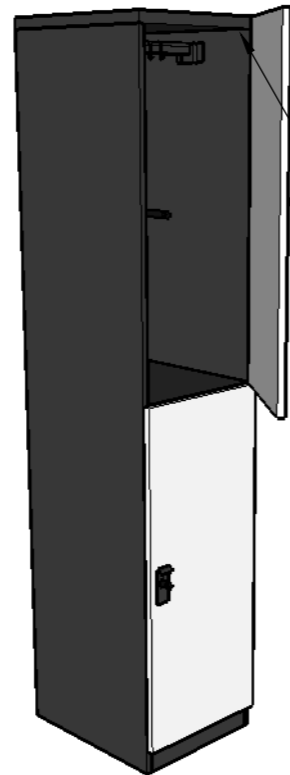

\*RAIL

MODEL B  
\*RAIL WITH 3 HOOKS

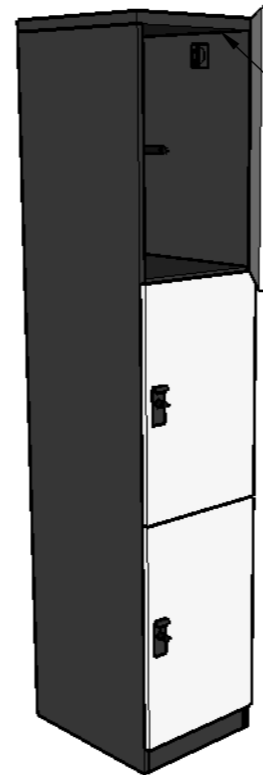

\* HOOKS

MODEL C  
\*ADDITIONAL HOOKS

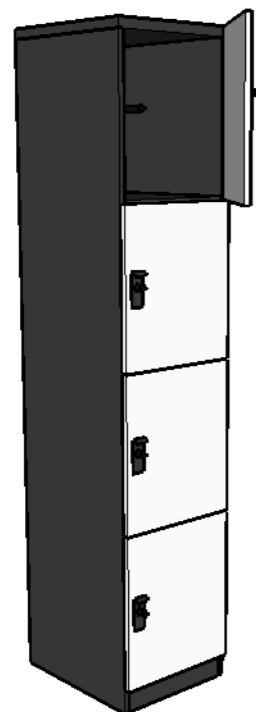

MODEL D

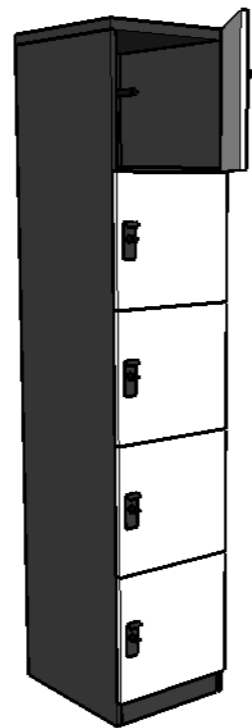

MODEL E

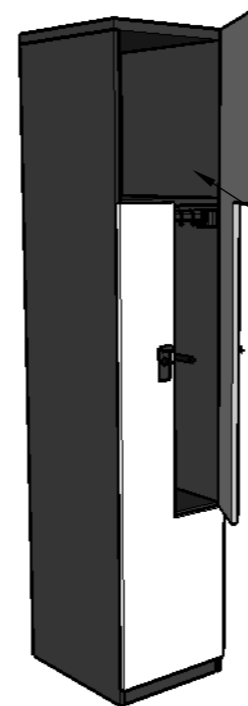

\* SHELF  
\* RAIL

MODEL L  
\*ADDITIONAL SHELF  
\*RAIL WITH 3 HOOKS

METAL BODY 0.8 MM  
POWDER COATED ACCORDING TO PALETTE RAL

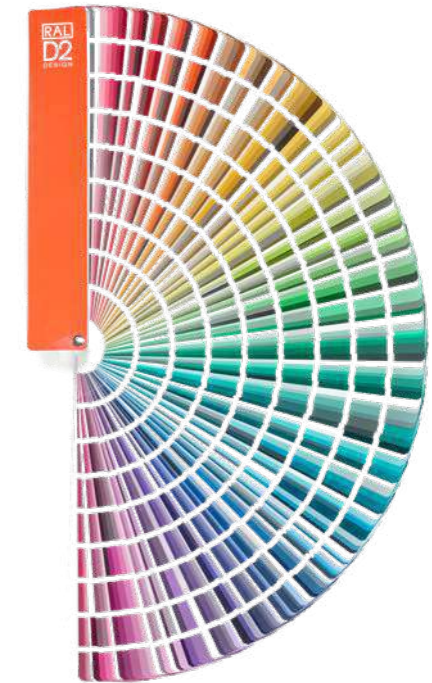

FRONT  
MDF BOARD 19 MM  
COLORS FROM PALETTE RAL



MDF BOARD LACQUERED ON  
HIGH GLOSS



MDF BOARD MAT

# KYLIA

## STANDARD DIMENSIONS

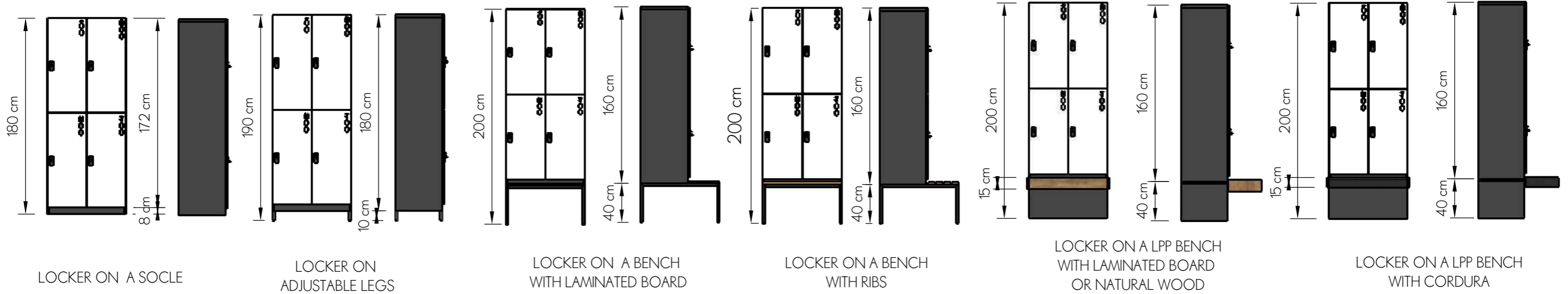

## CUSTOM DIMENSIONS

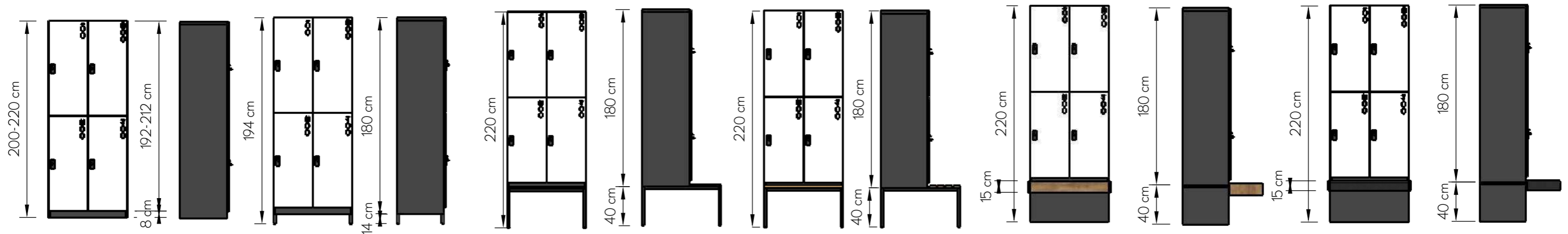

### METAL BODY

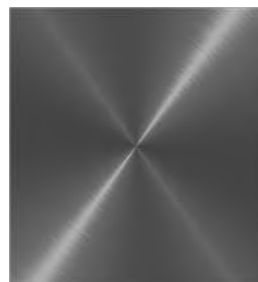

BODY IS MADE OF HIGH QUALITY METAL 0,8 MM THICK. LOCKER IS POWDER COATED ACCORDING TO PALETTE RAL. LOCKERS ARE MADE IN ACCORDANCE WITH EUROPEAN STANDARDS.

### FRONT MADE OF MDF BOARD

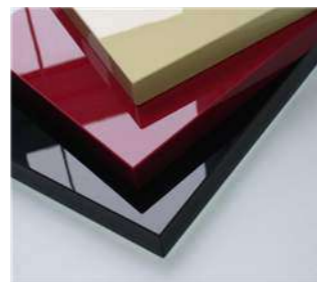

THIS IS WOOD PLATE. MDF BOARD IS MADE OF COMPRESSION WOOD FIBER WITH ORGANIC COMPOUNDS. THE MATERIAL HAS HOMOGENEOUS DENSITY AND IS CHARACTERISED BY GREAT WORKABILITY MECHANICAL.

### BENCH FINISHING



CORDURA



LAMINATED BOARD



NATURAL WOOD



RIBS



AMEZ ZEUS

ARTER







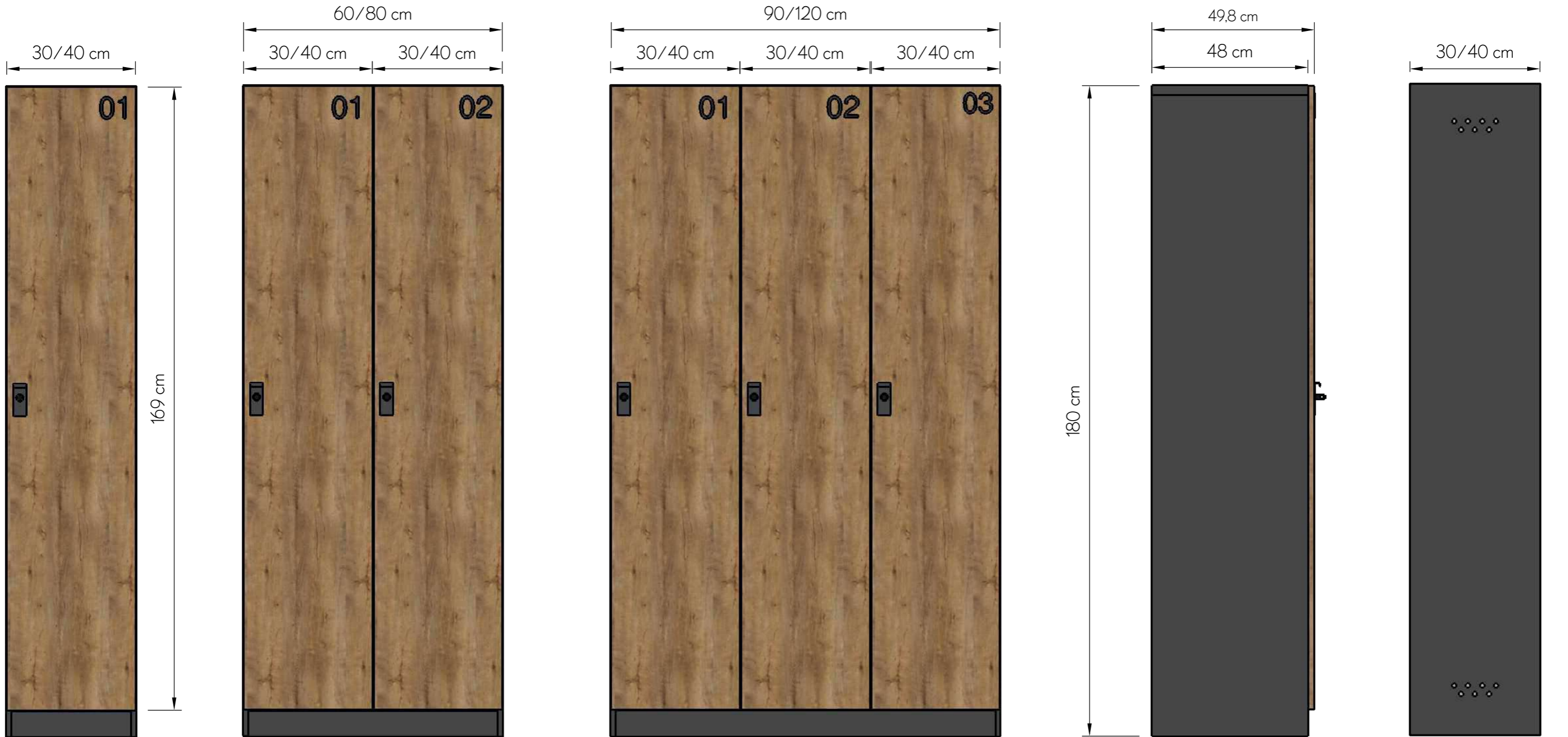

A1

A2

A3

SIDE VIEW

BACK VIEW  
VENTILATION

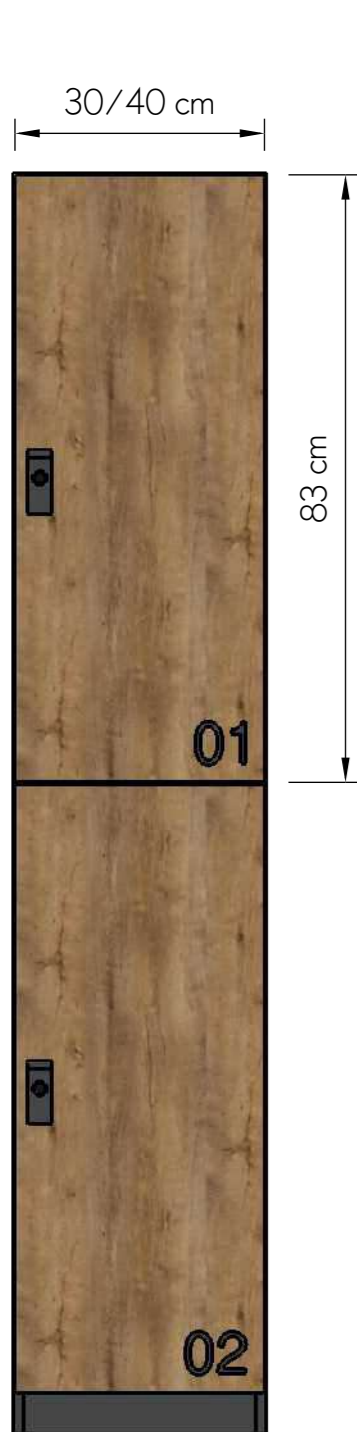

B2

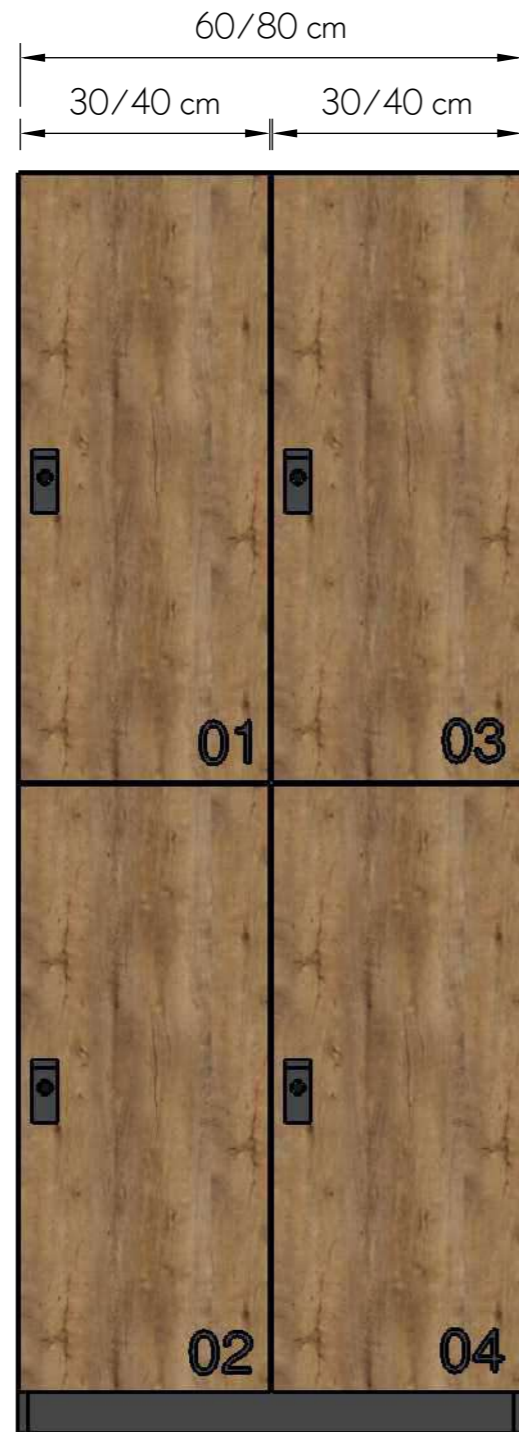

B4



B6

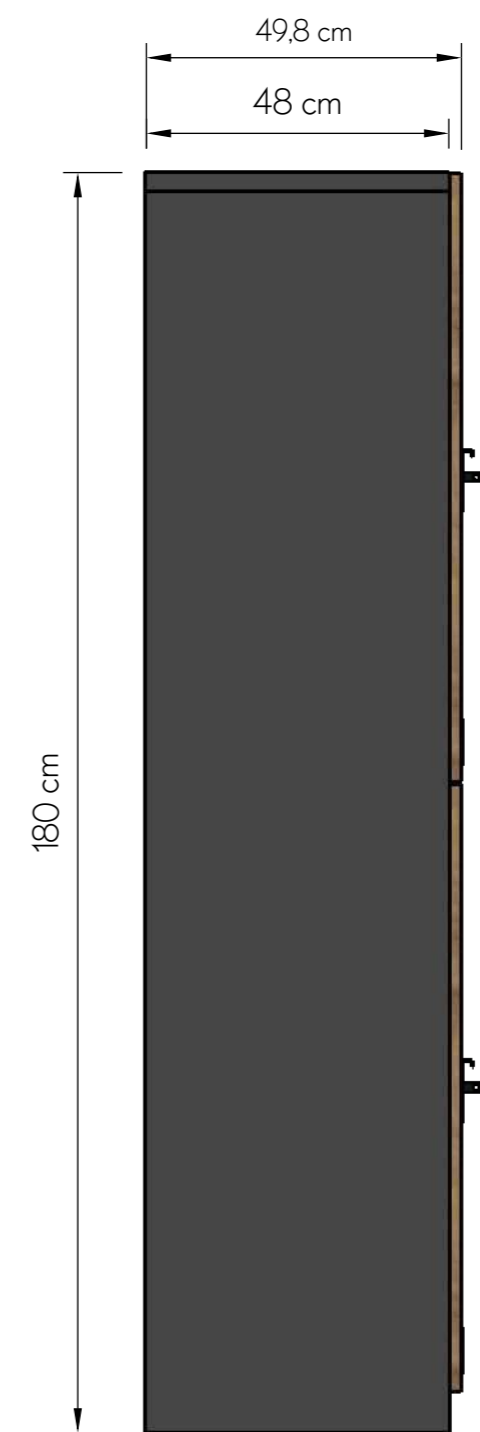

SIDE VIEW

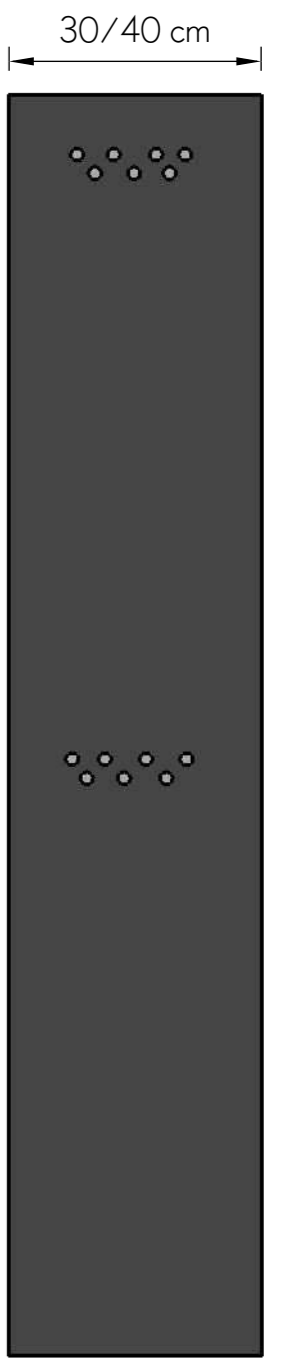

BACK VIEW  
VENTILATION



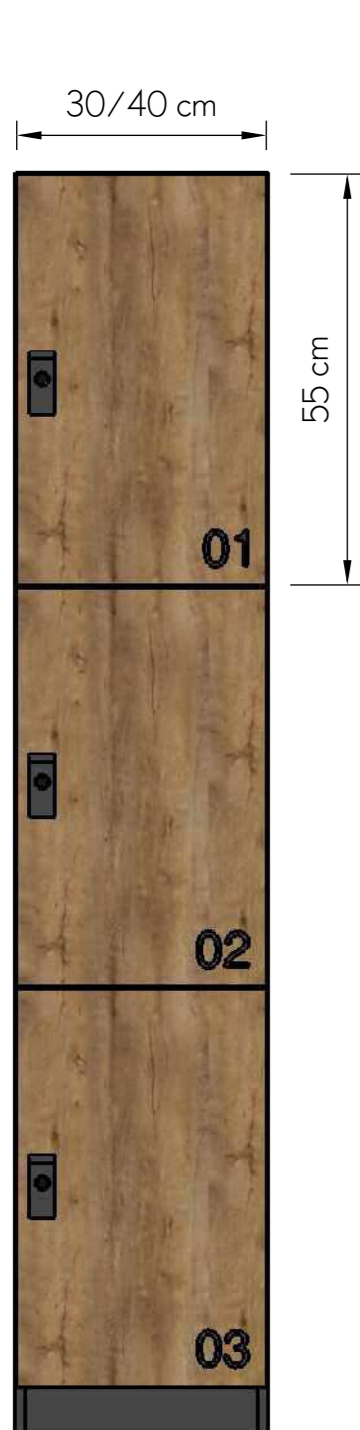

C3

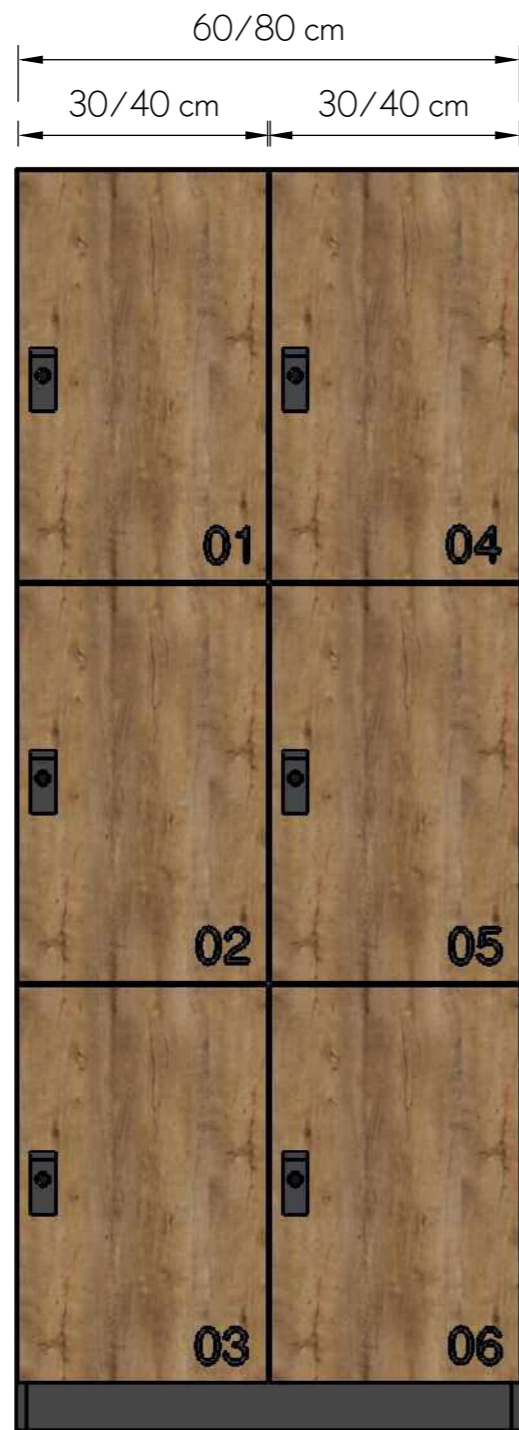

C6



C9

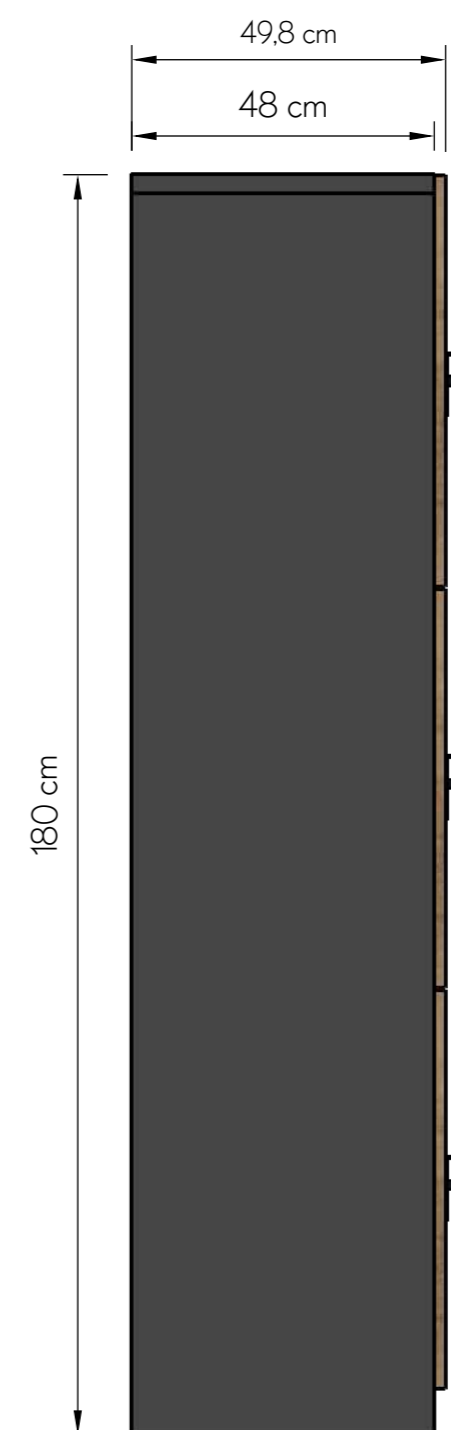

SIDE VIEW

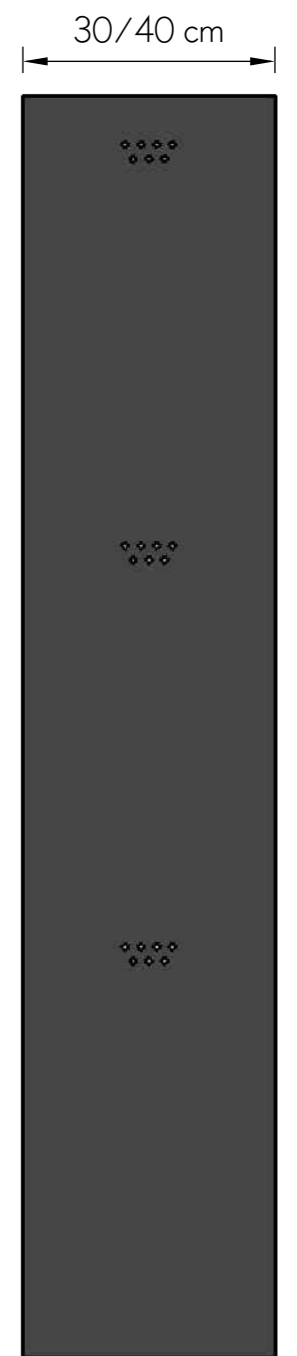

BACK VIEW  
VENTILATION



D4



D8

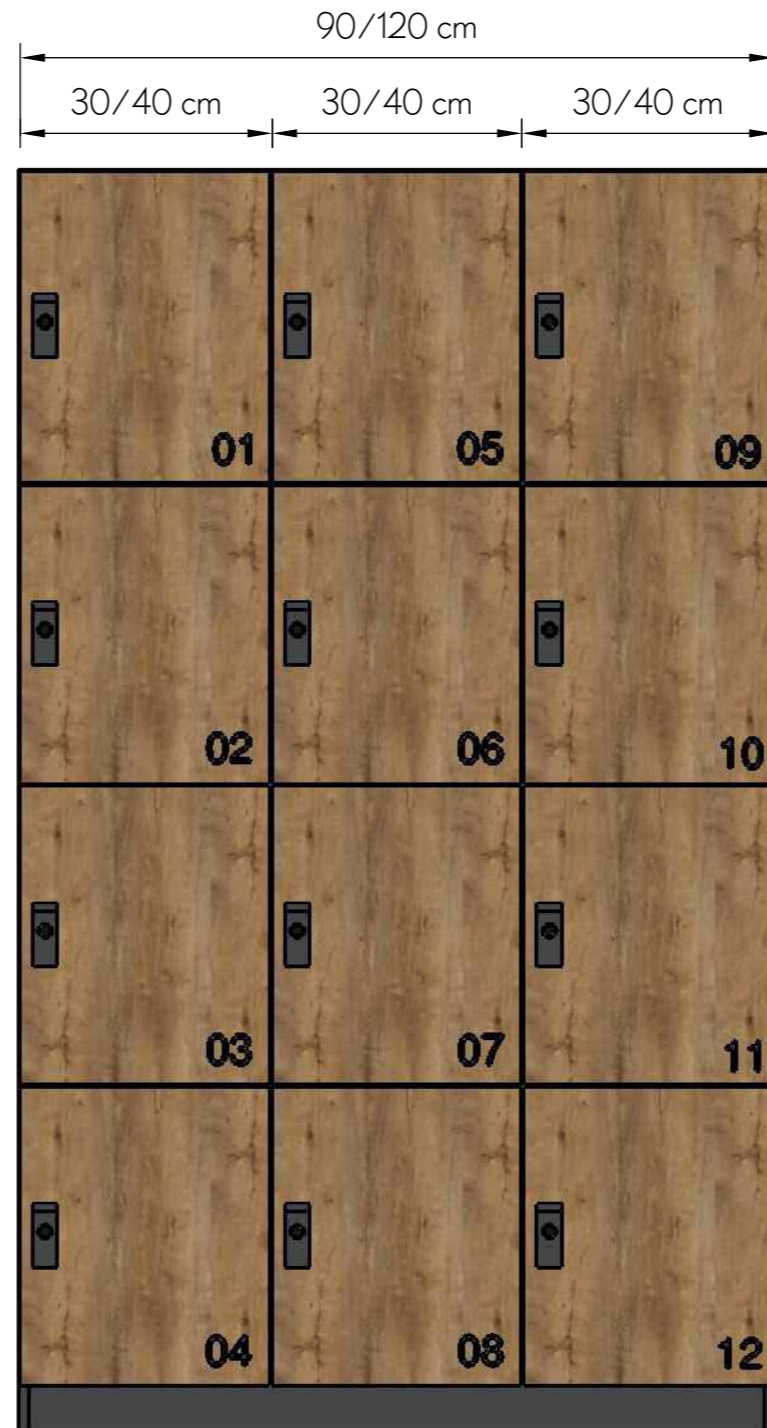

D12

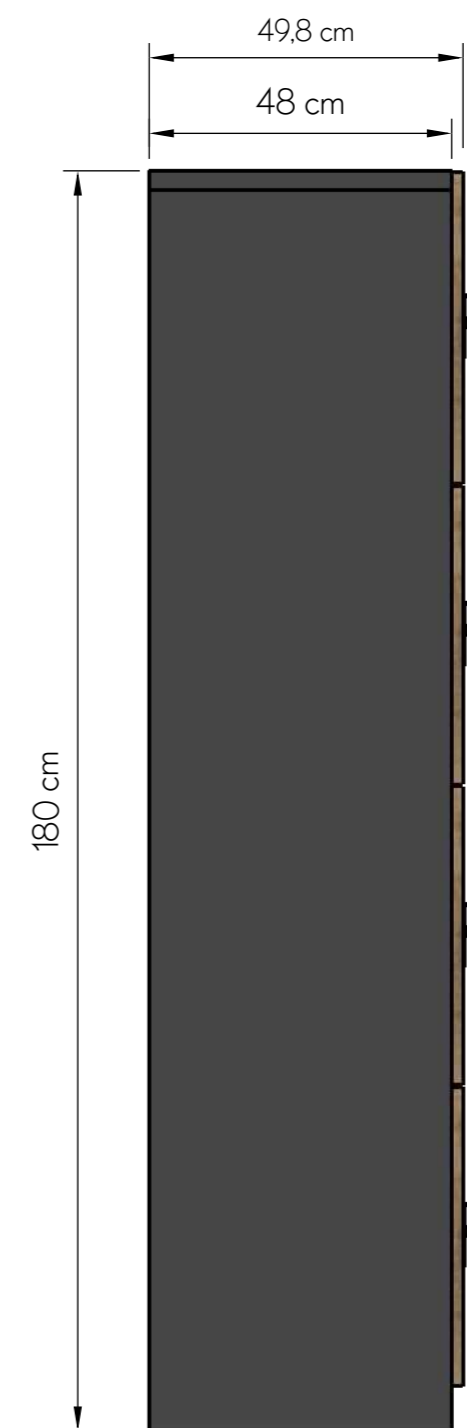

SIDE VIEW

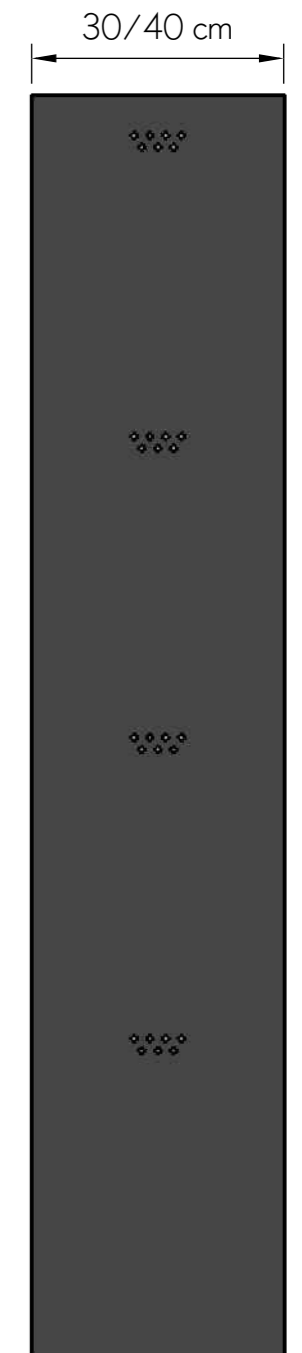

BACK VIEW  
VENTILATION



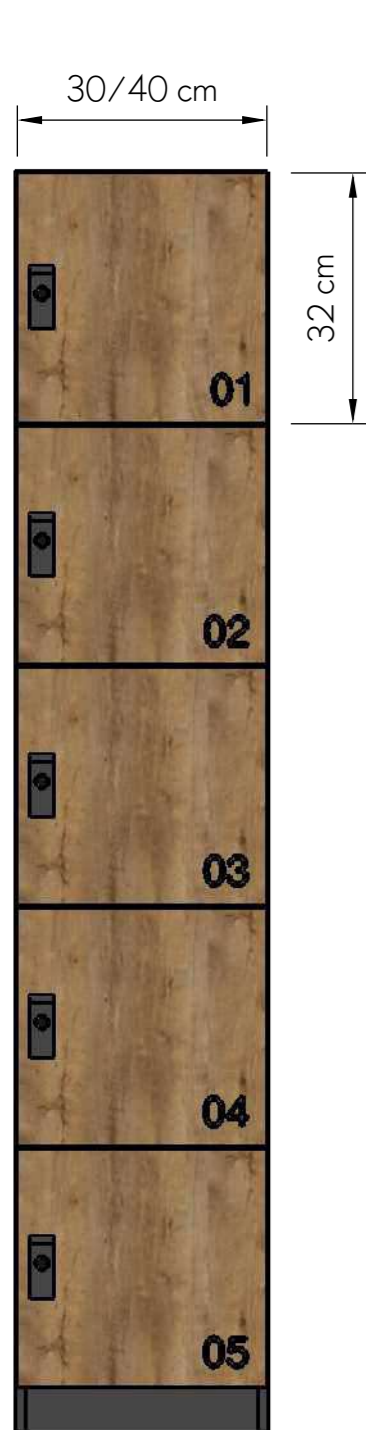

E5

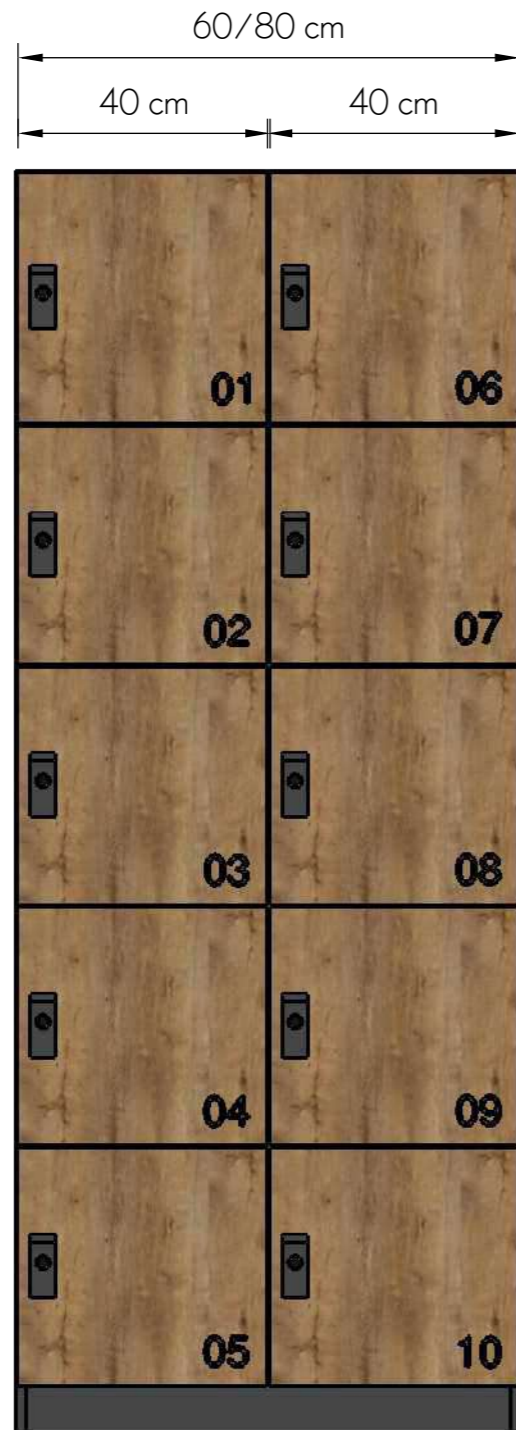

E10

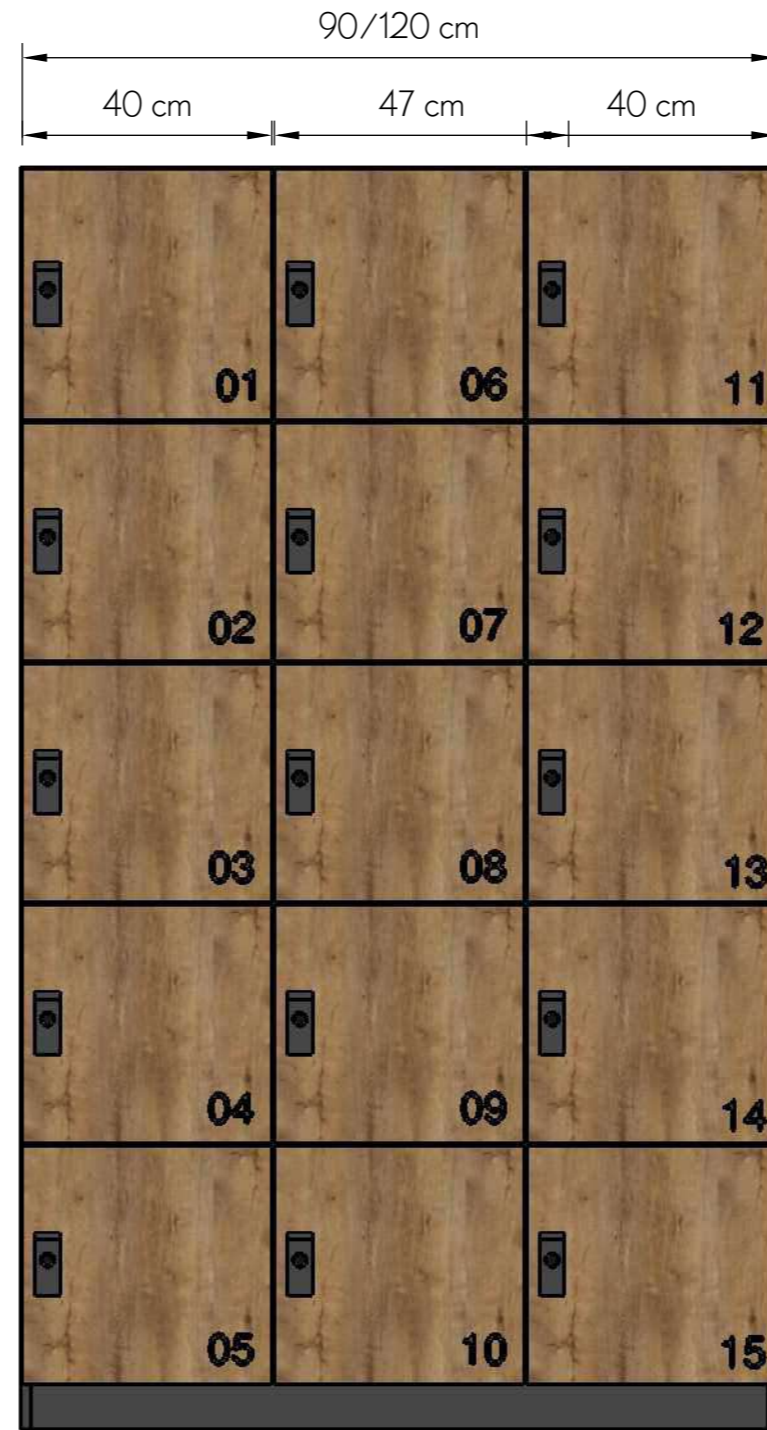

E15

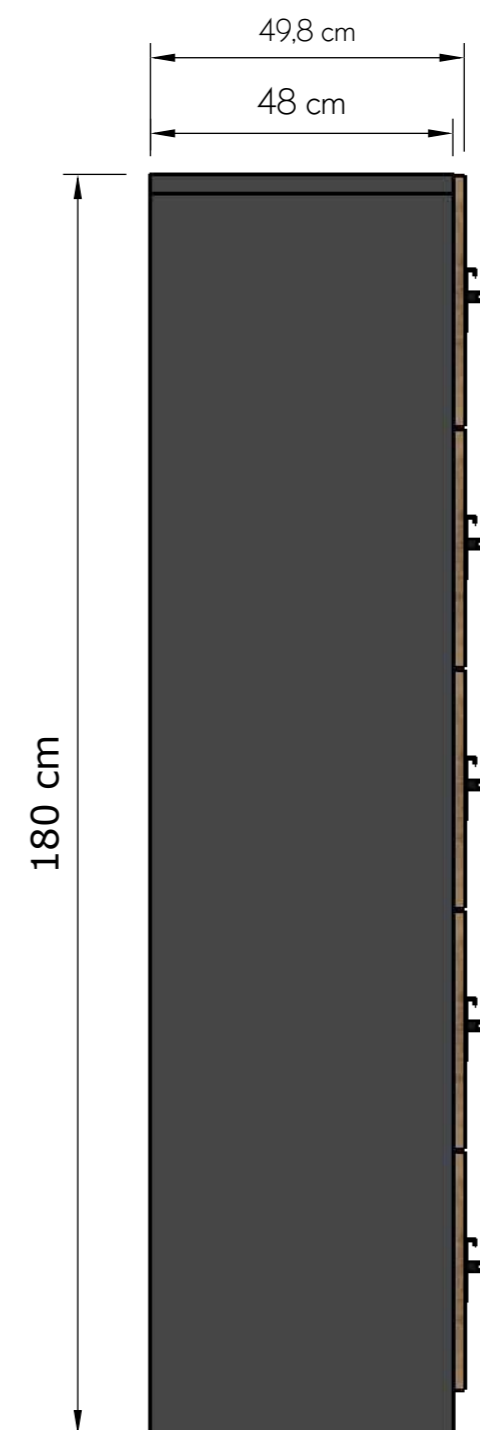

SIDE VIEW

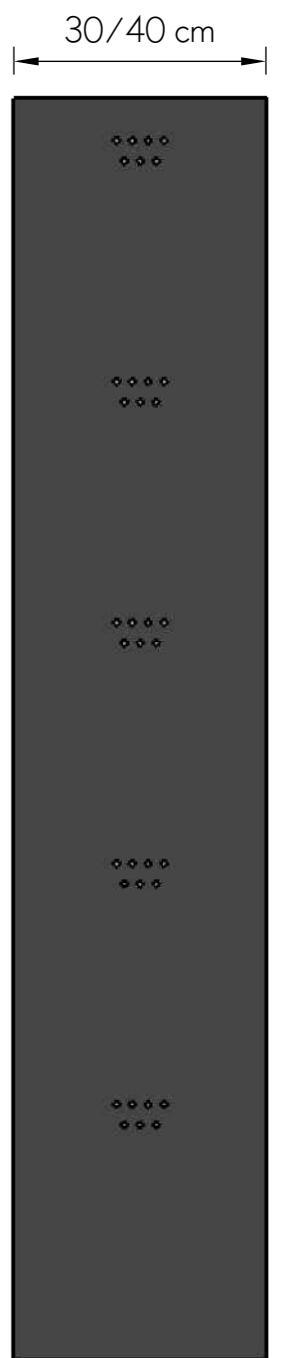

BACK VIEW  
VENTILATION



L2



L4



L6

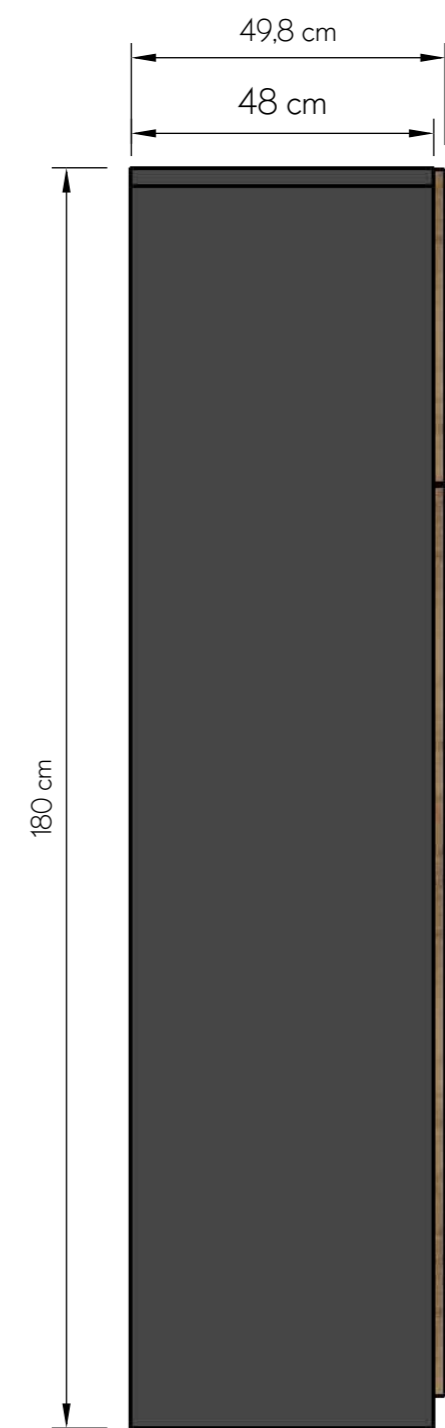

SIDE VIEW

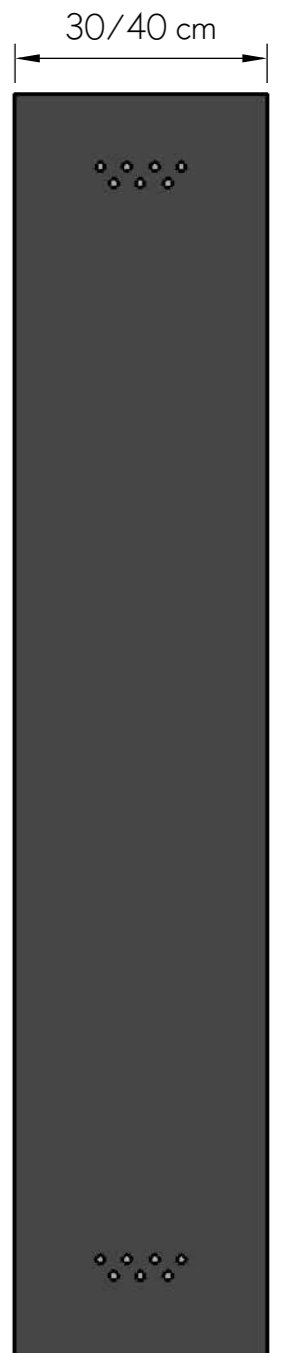

BACK VIEW  
VENTILATION



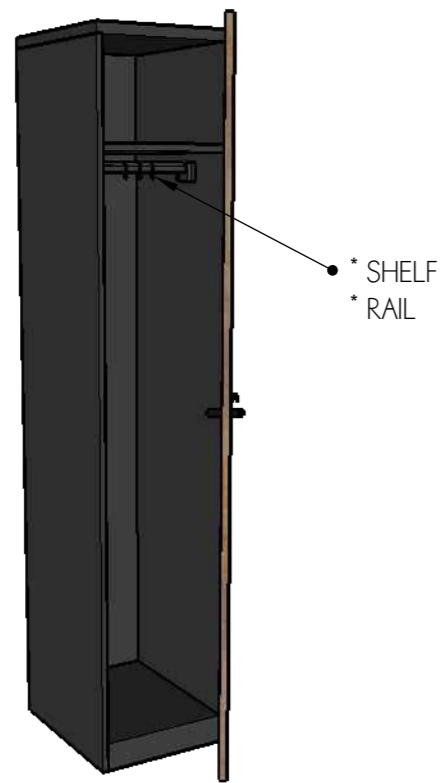

MODEL A  
\* ADDITIONAL SHELF  
\* RAIL WITH 3 HOOKS

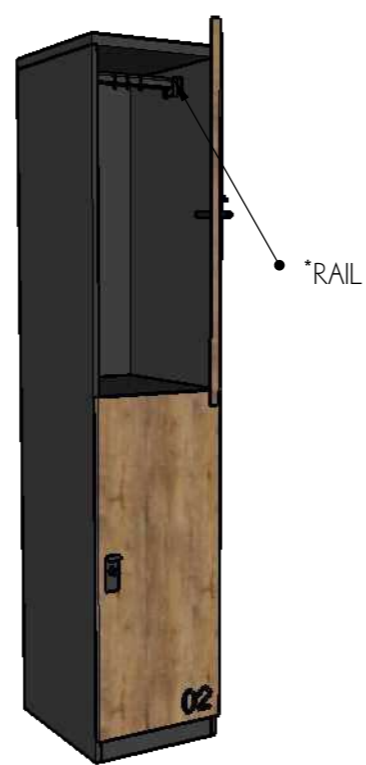

MODEL B  
\* RAIL WITH 3 HOOKS

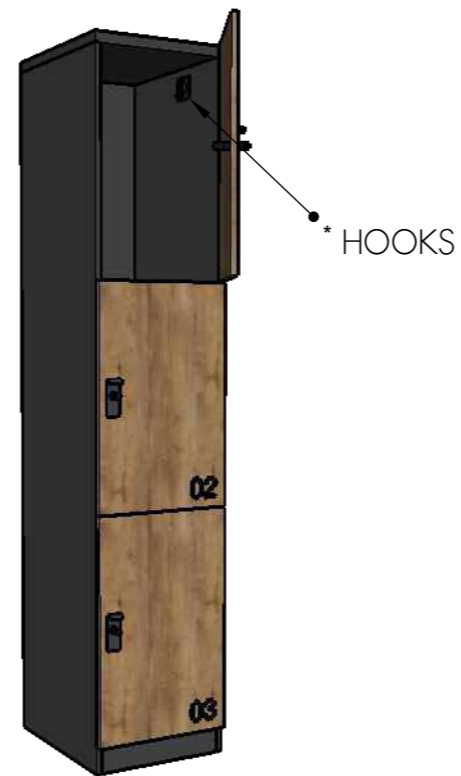

MODEL C  
\* ADDITIONAL HOOKS



MODEL D



MODEL E

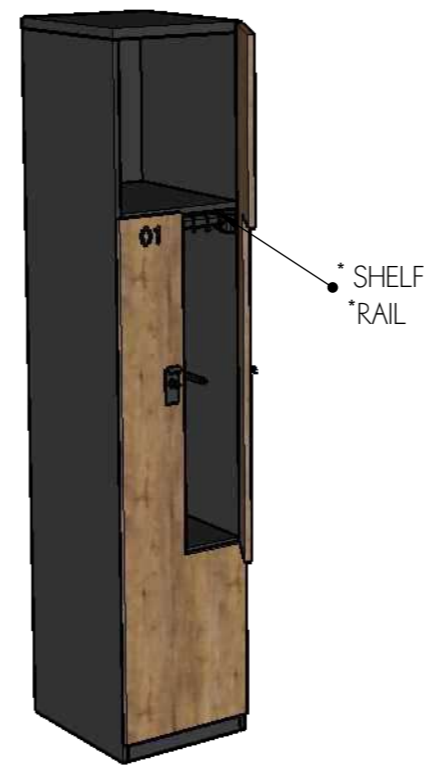

MODEL L  
\* ADDITIONAL SHELF  
\* RAIL WITH 3 HOOKS

METAL BODY 0.8 MM  
POWDER COATED ACCORDING TO PALETTE RAL



FRONT  
LAMINATED BOARD 18MM



MONOCOLORS



WOOD DECORS

# ARTER

## STANDARD DIMENSIONS

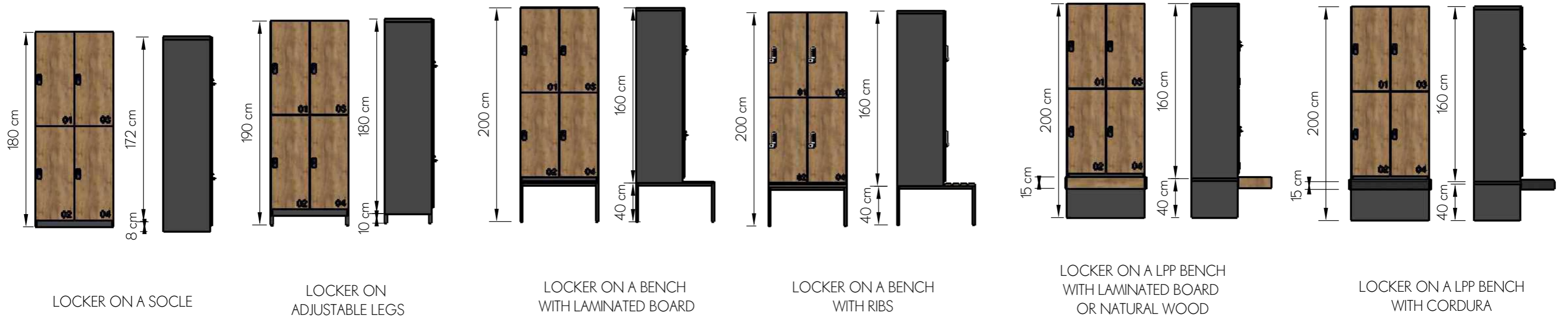

## CUSTOM DIMENSIONS

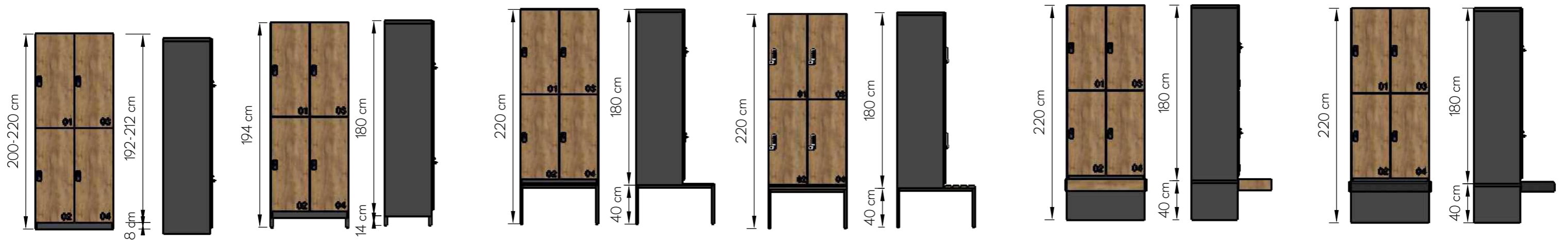

### METAL BODY



BODY IS MADE OF HIGH QUALITY METAL 0,8 MM THICK. LOCKER IS POWDER COATED ACCORDING TO PALETTE RAL. LOCKERS ARE MADE IN ACCORDANCE WITH EUROPEAN STANDARDS.

### FRONT MADE OF LAMINATED BOARD



LAMINATED BOARD IS CHARACTERIZED BY HIGH MECHANICAL STRENGTH THANKS TO MULTI-LAYER STRUTURE. HIGH DURABILITY MAKES THEM RESISTANT FOR SCRATCHES, IMPACT, DIRT AND EASY IN CLEANING.

### BENCH FINISHING



CORDURA



LAMINATED BOARD



NATURAL WOOD



RIBS



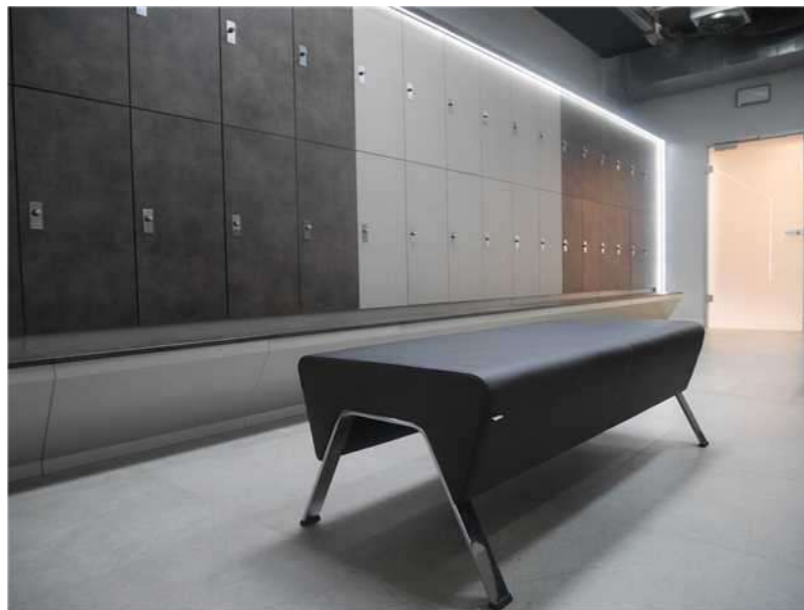

AMEZ ZEUS

HYBOR



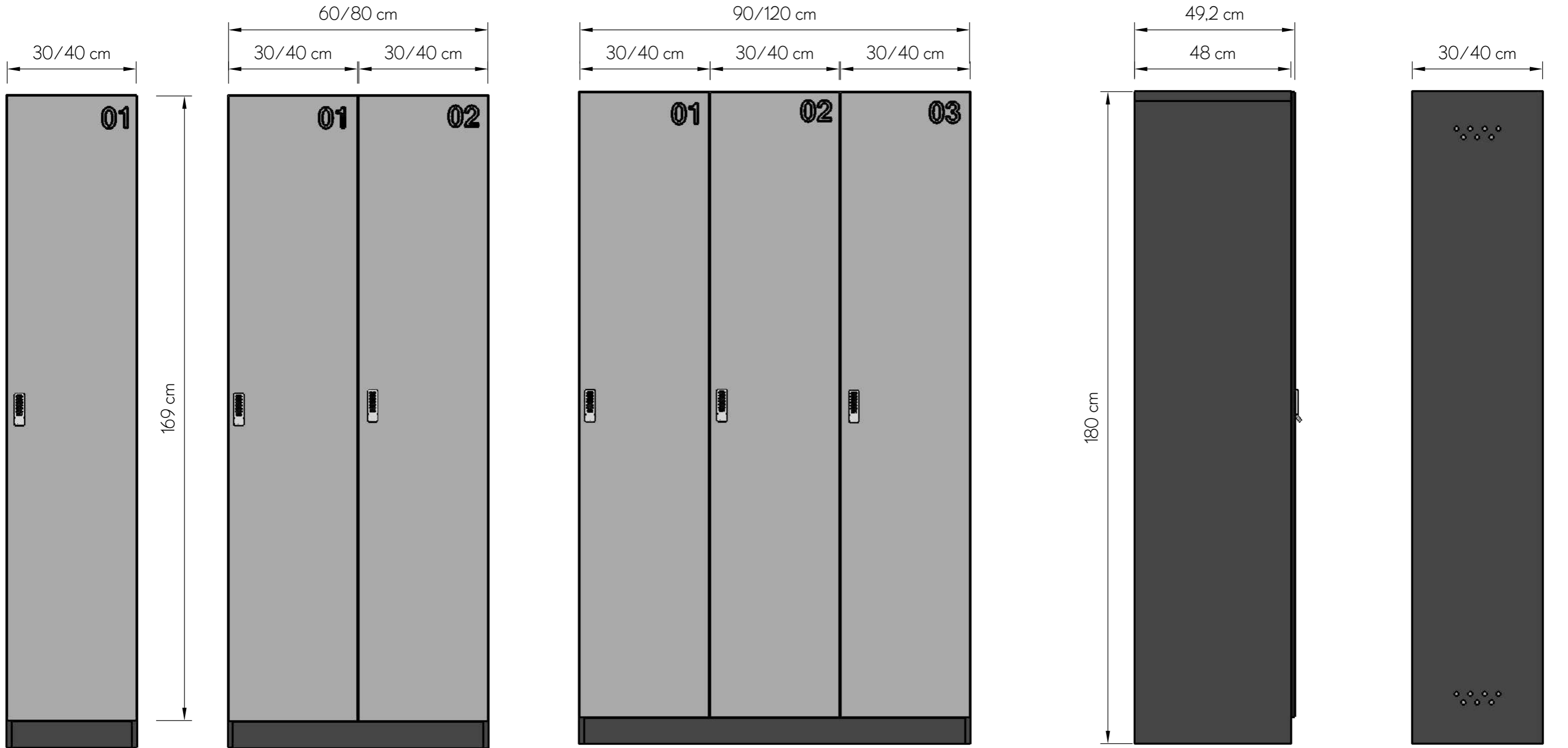

A1

A2

A3

SIDE VIEW

BACK VIEW  
VENTILATION



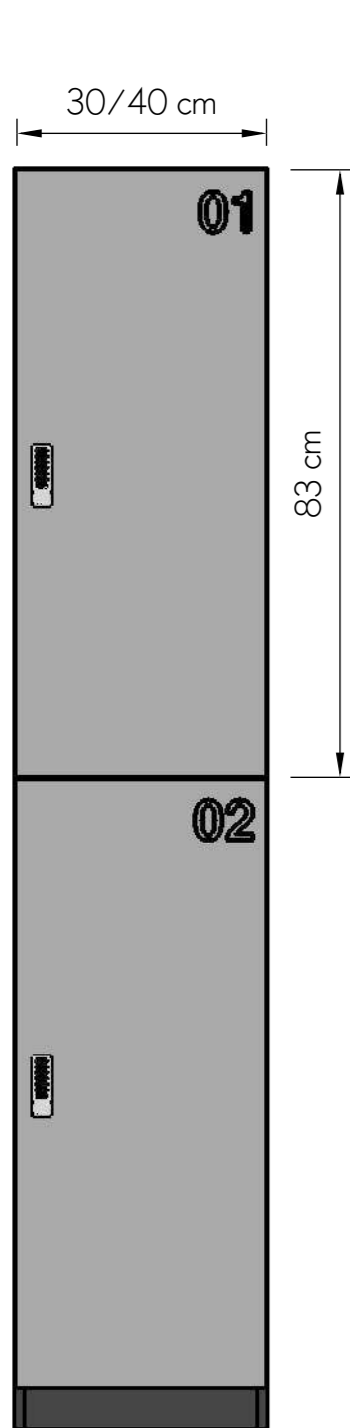

B2

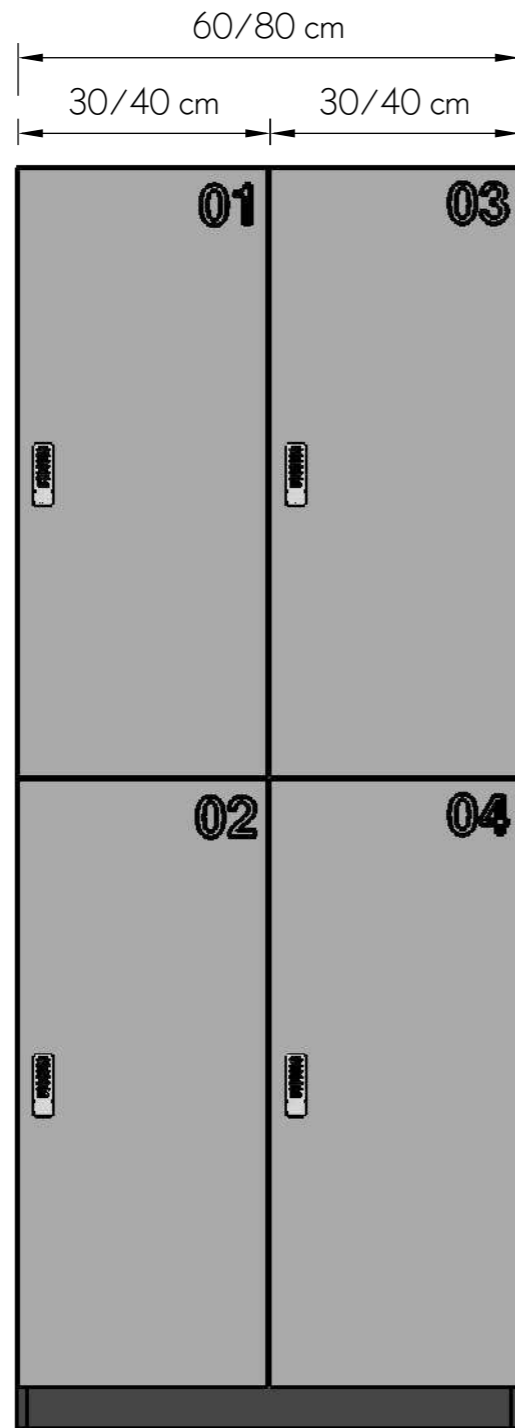

B4

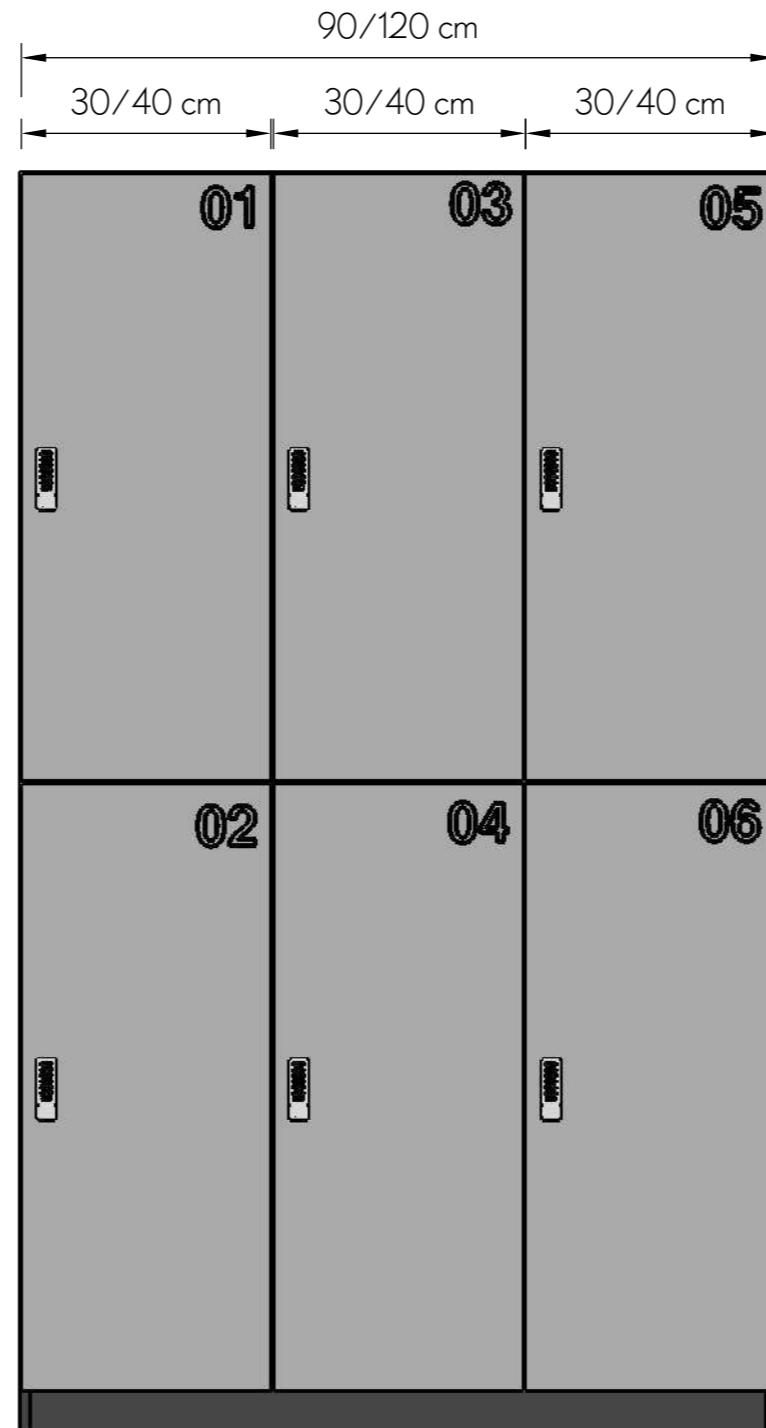

B6

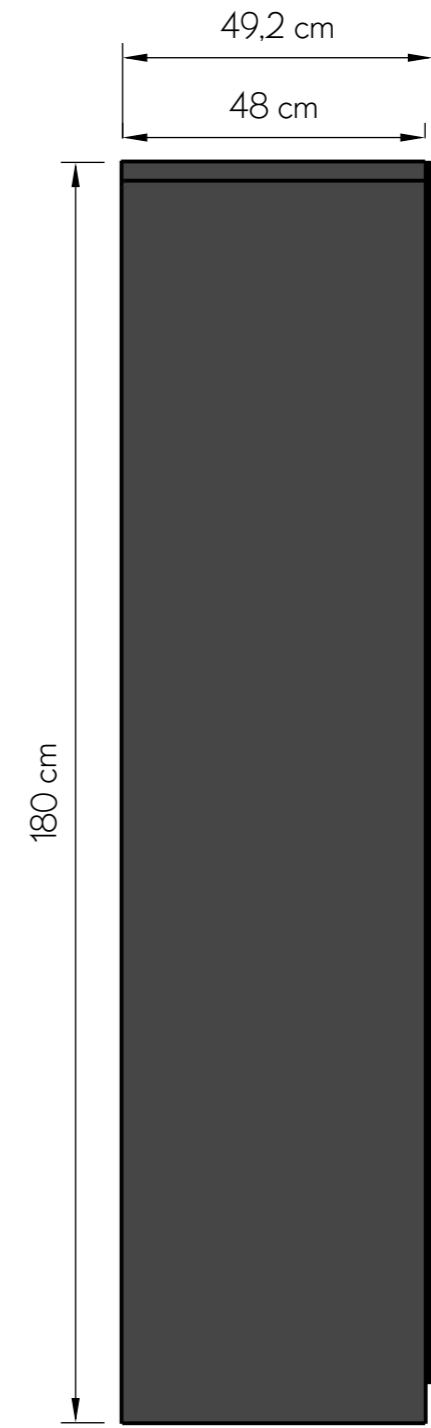

SIDE VIEW

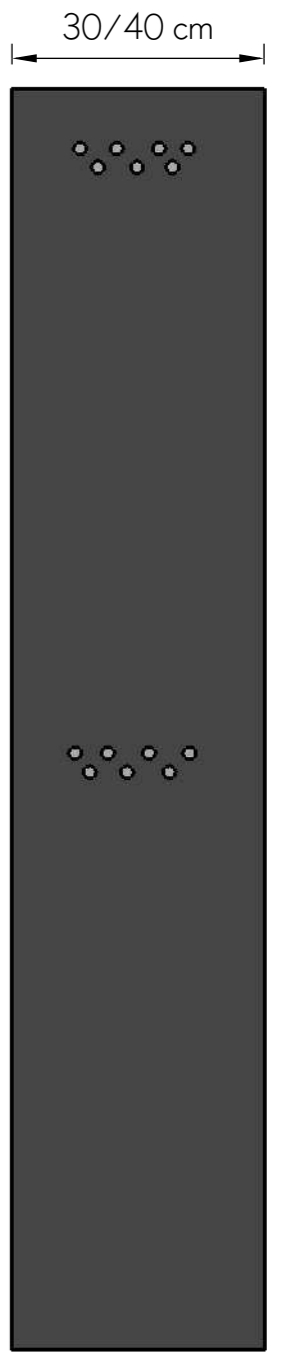

BACK VIEW  
VENTILATION

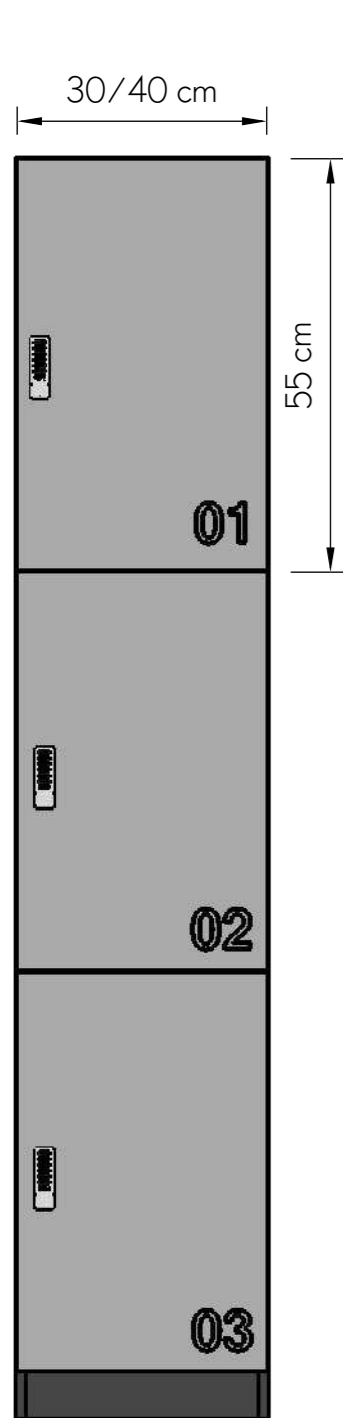

C3

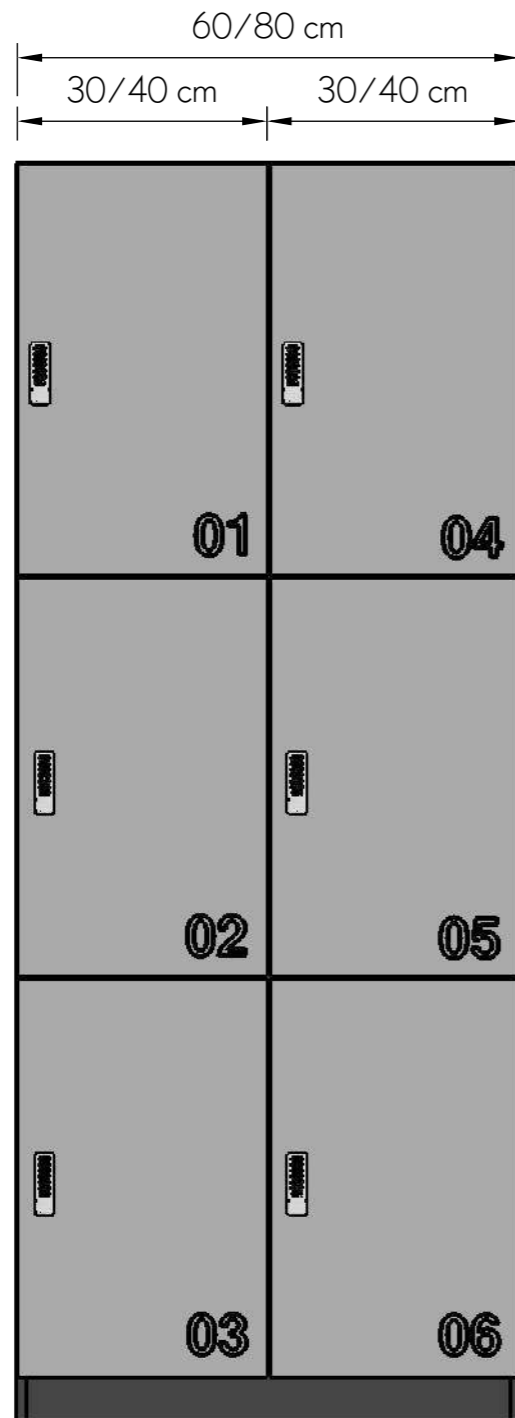

C6

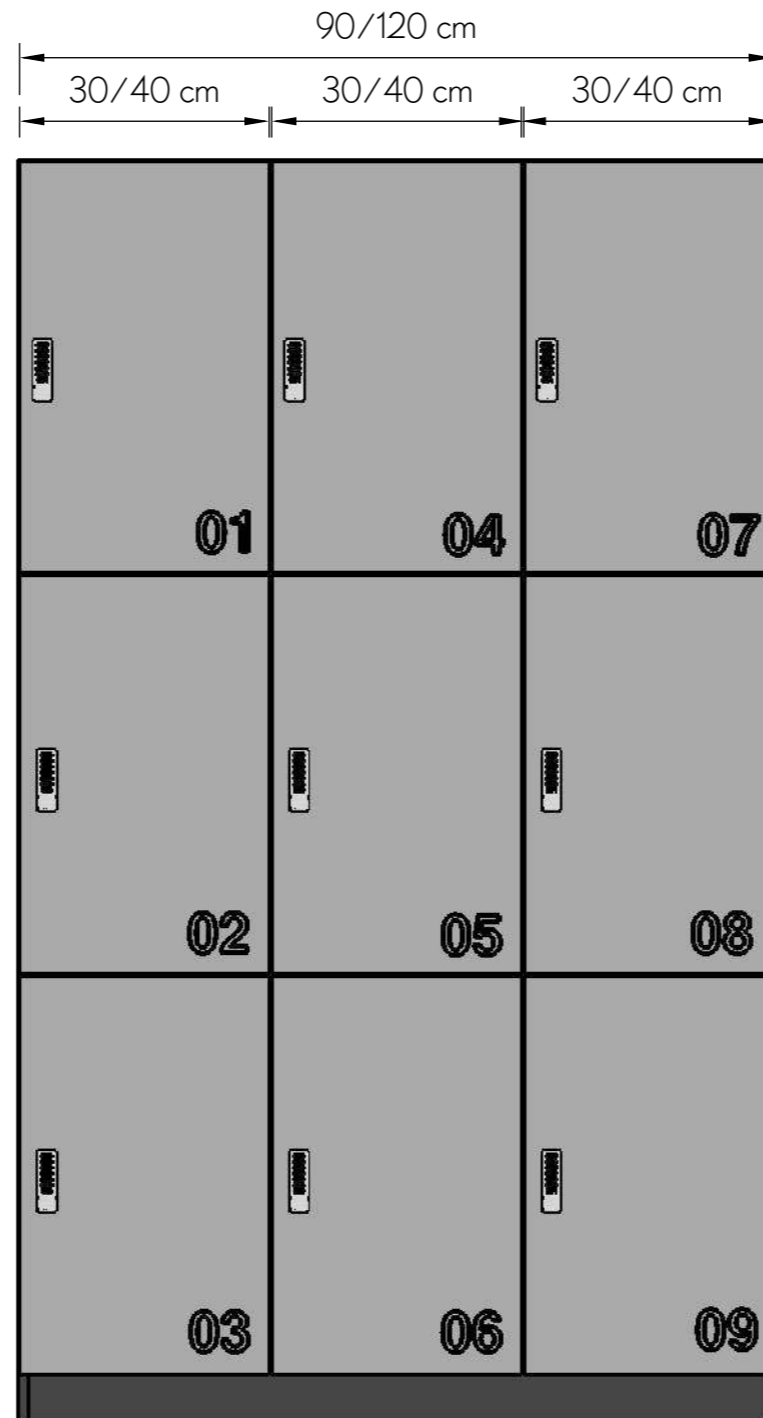

C9

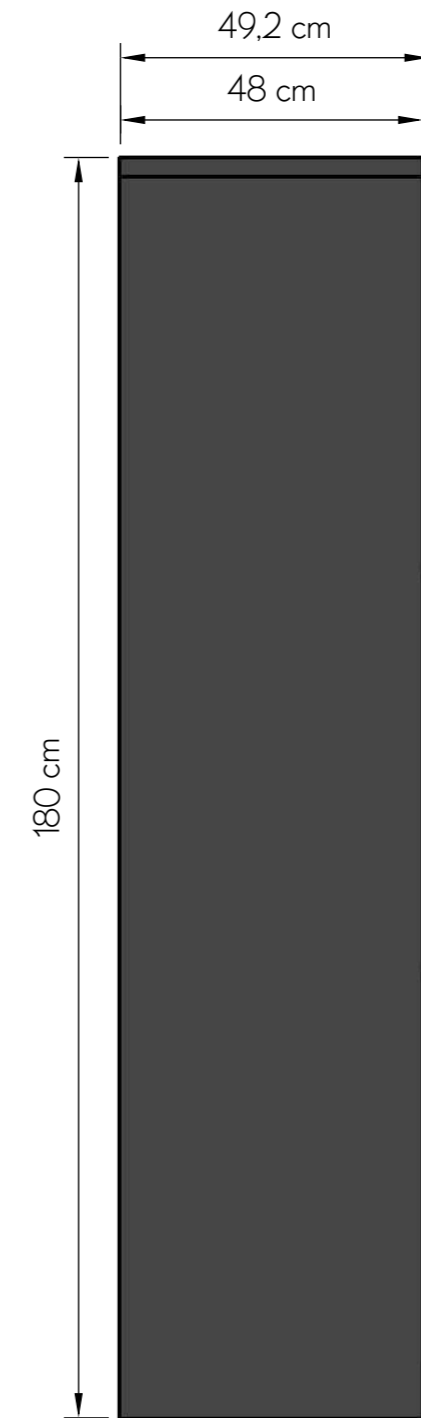

SIDE VIEW

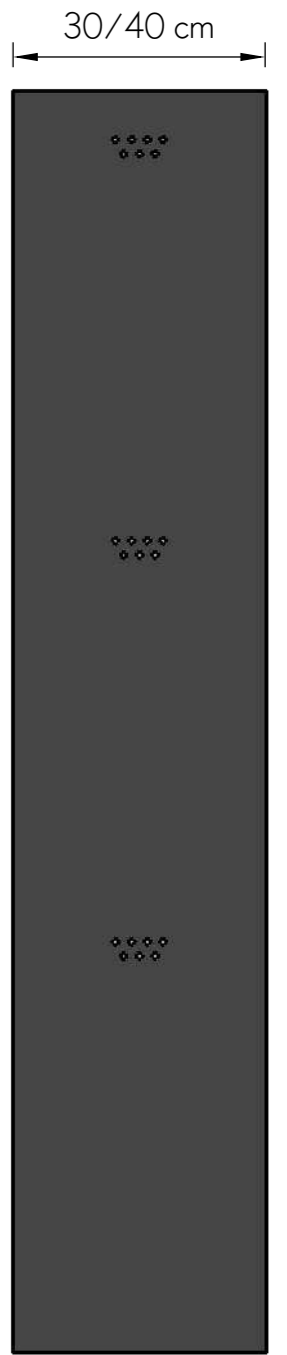

BACK VIEW  
VENTILATION

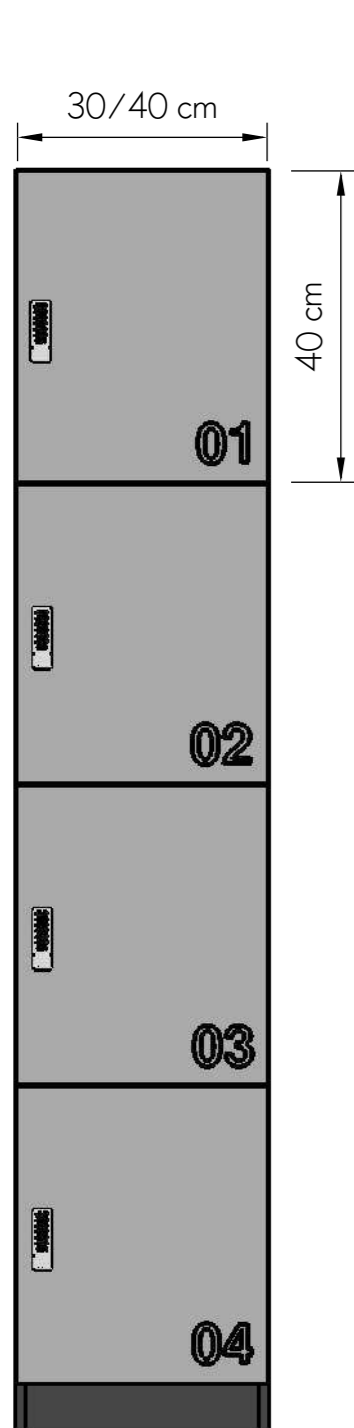

D4

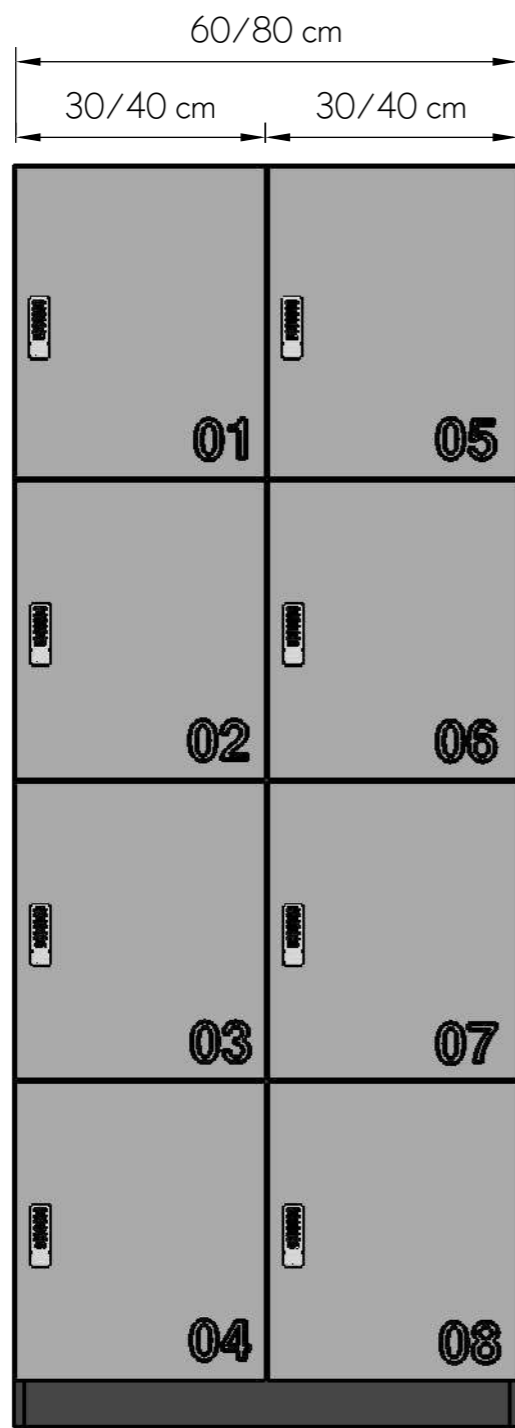

D8

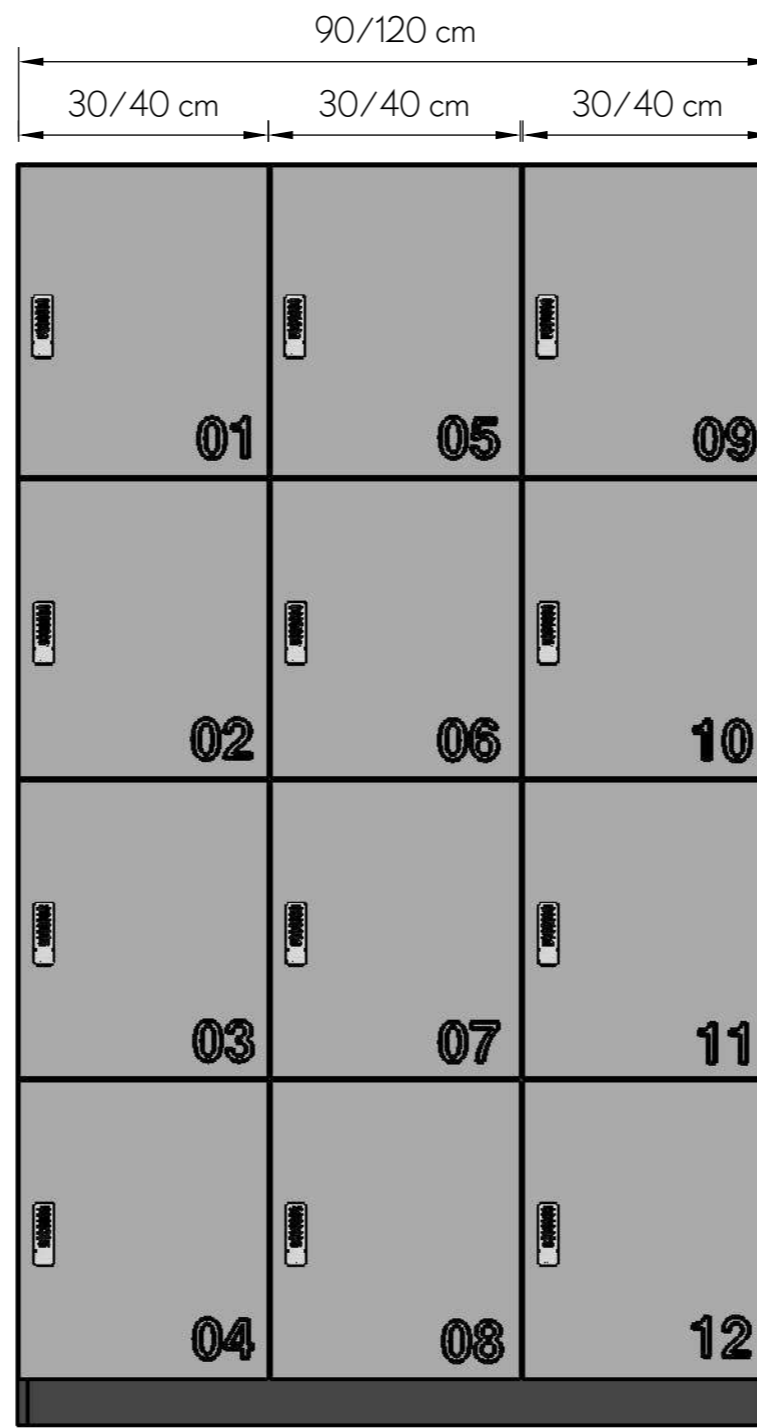

D12

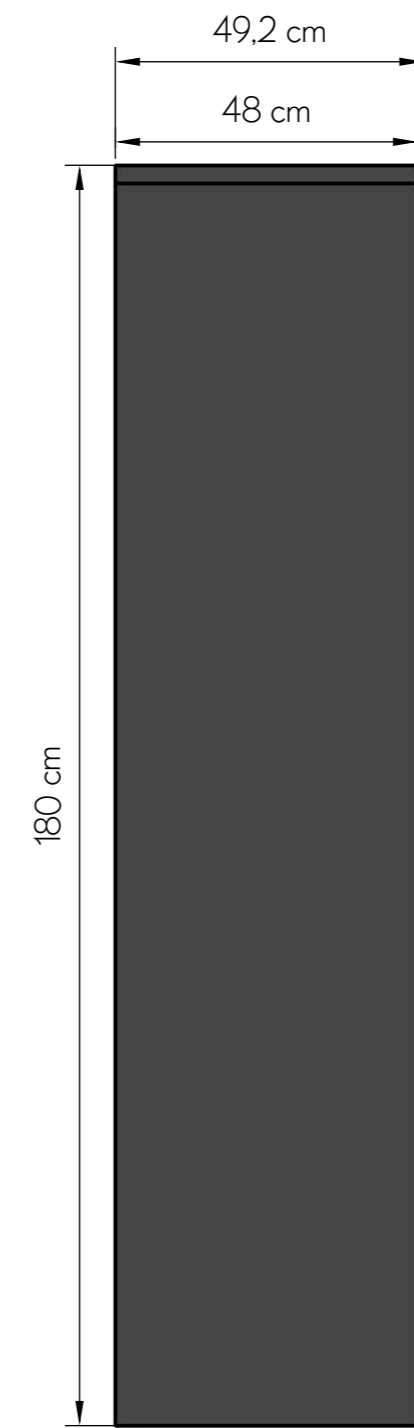

SIDE VIEW



BACK VIEW  
VENTILATION

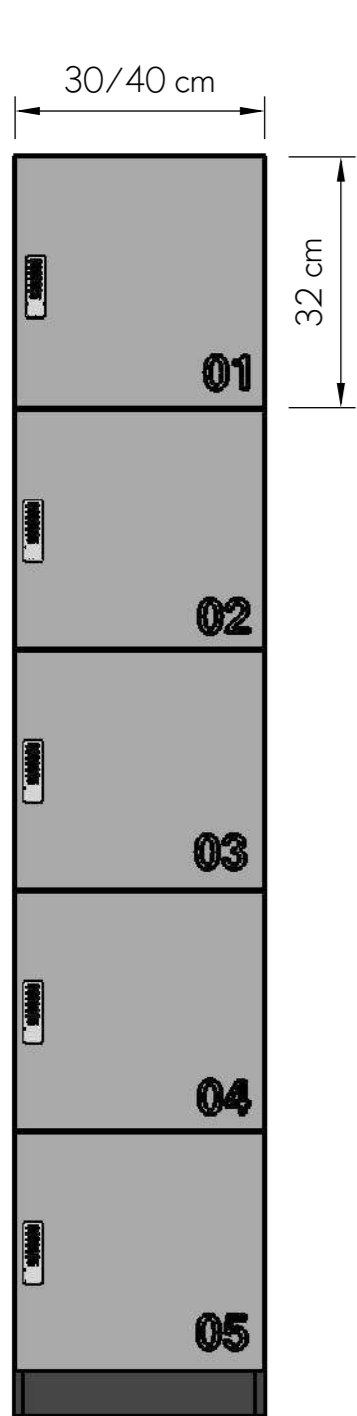

E5

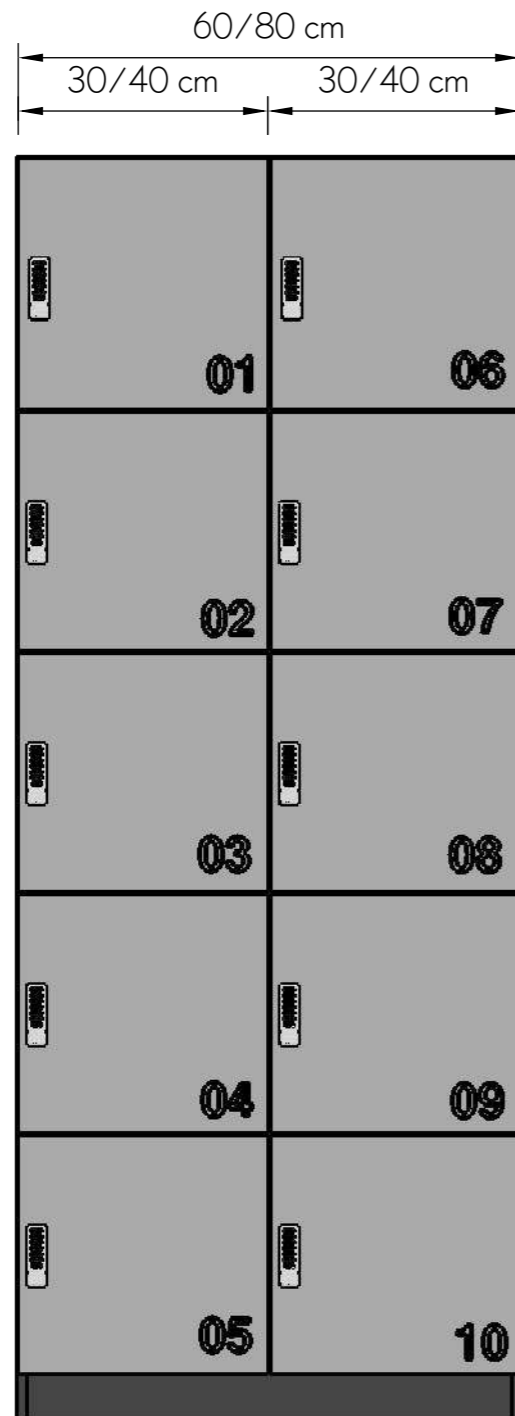

E10

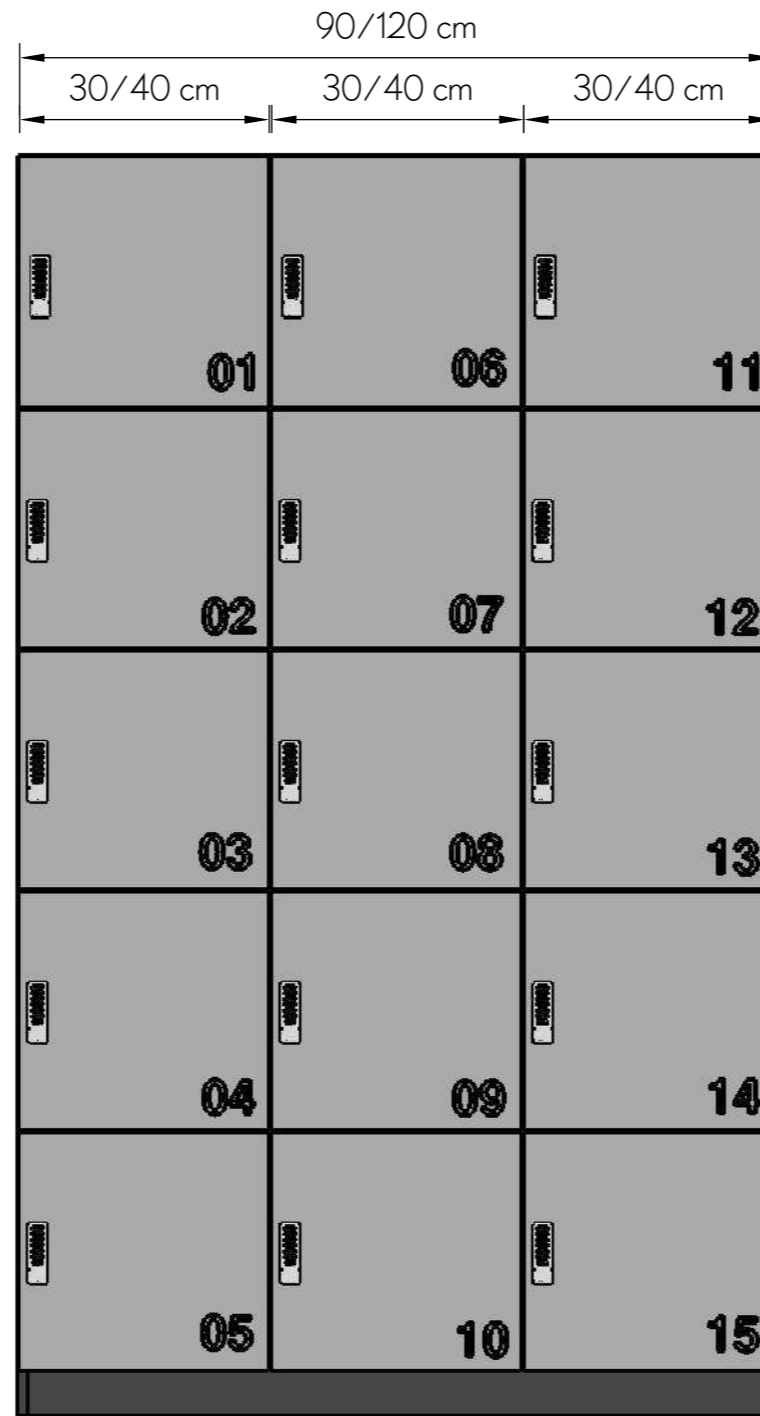

E15

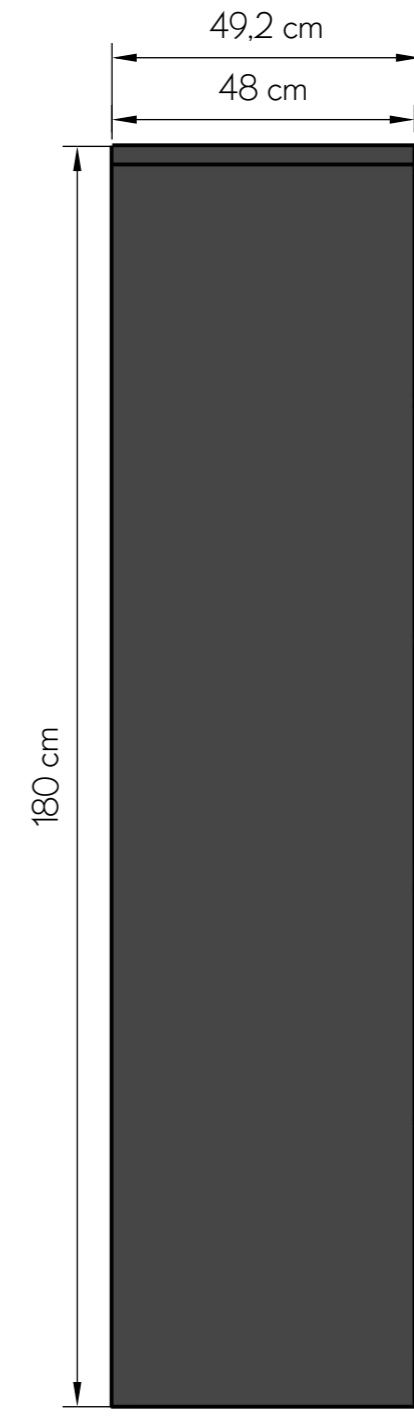

SIDE VIEW

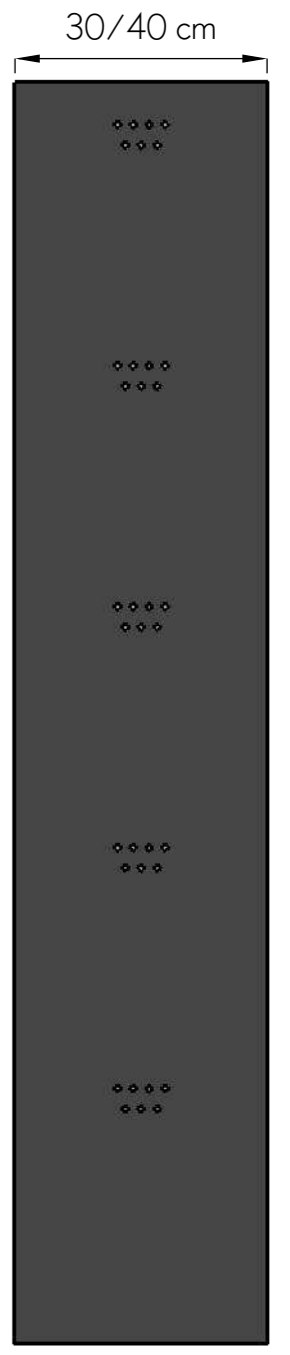

BACK VIEW  
VENTILATION



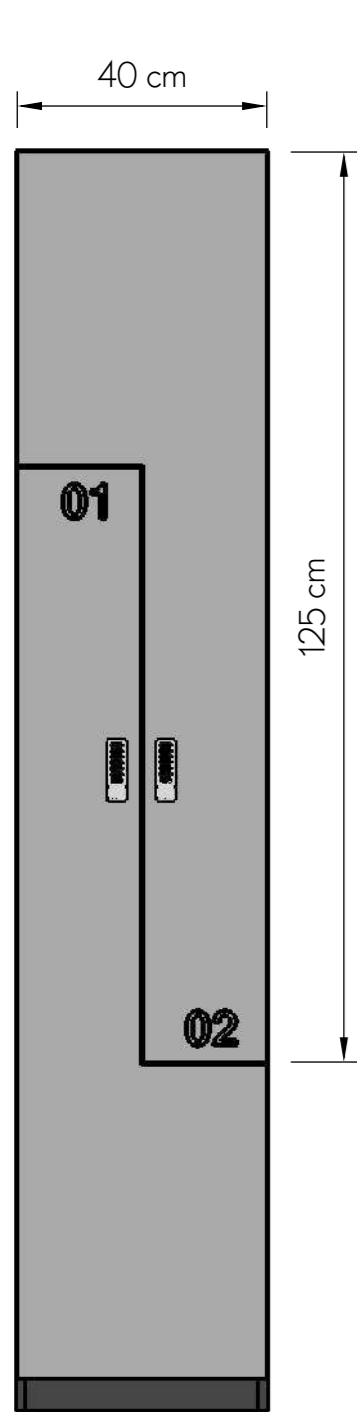

L2

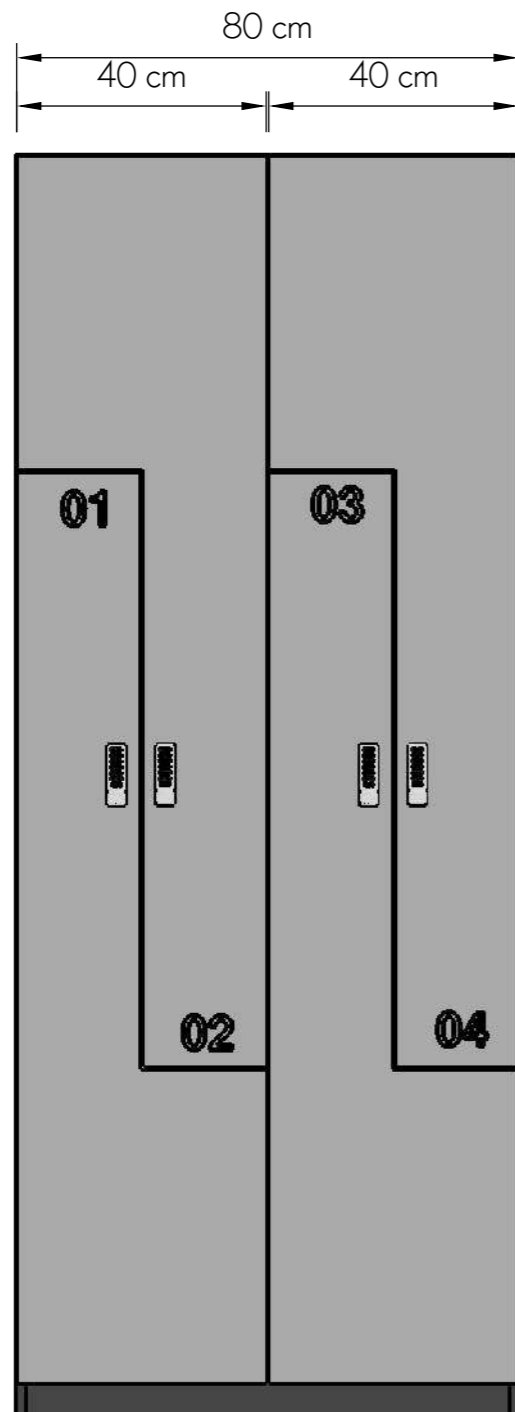

L4

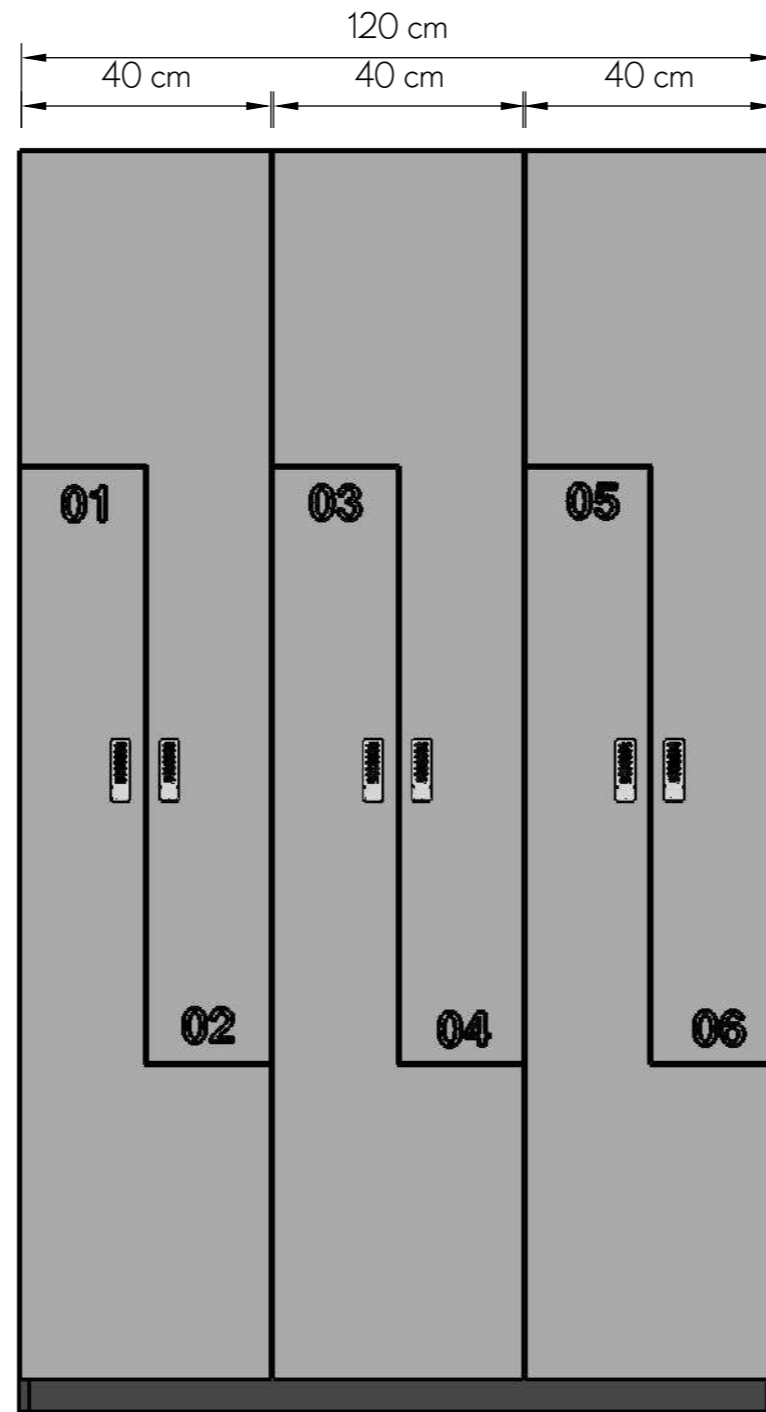

L6



SIDE VIEW

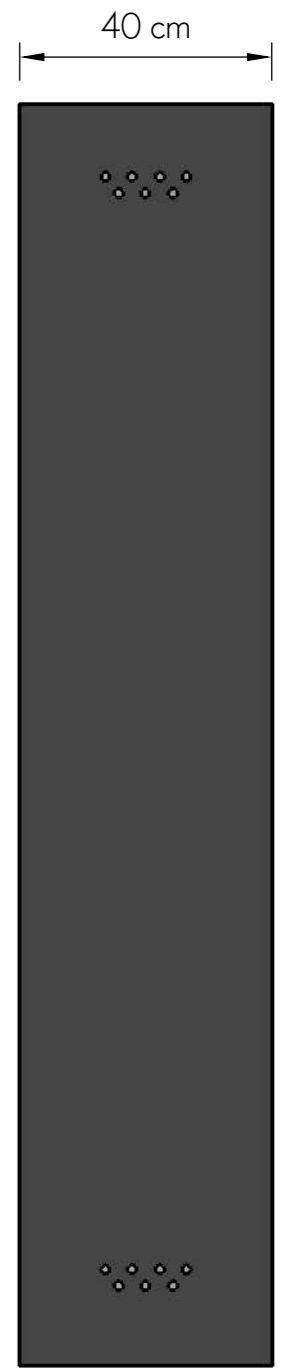

BACK VIEW  
VENTILATION

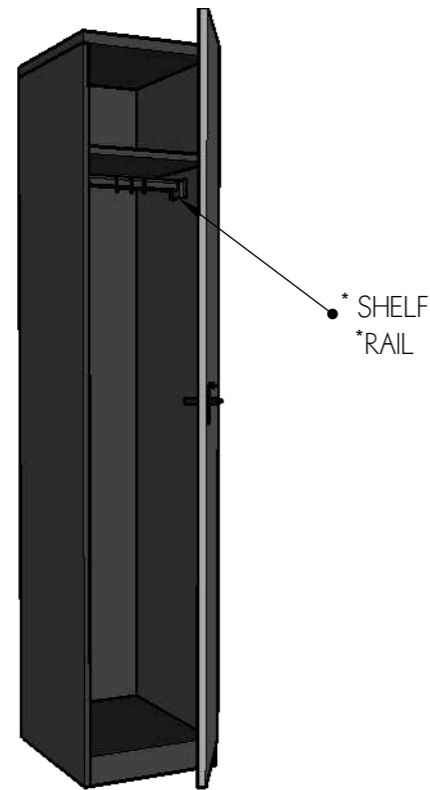

MODEL A  
\* ADDITIONAL SHELF  
\* RAIL WITH 3 HOOKS

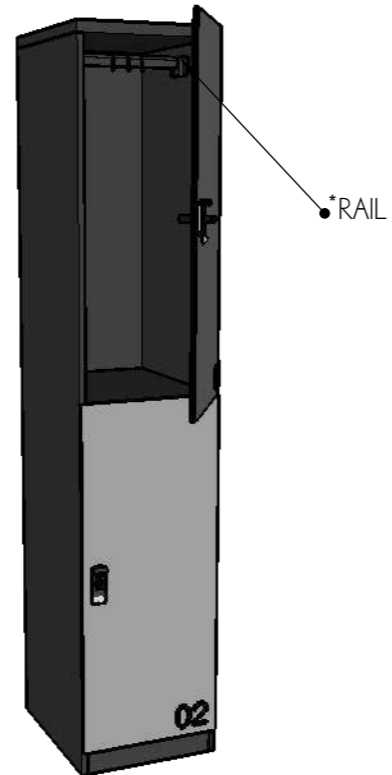

MODEL B  
\* RAIL WITH 3 HOOKS

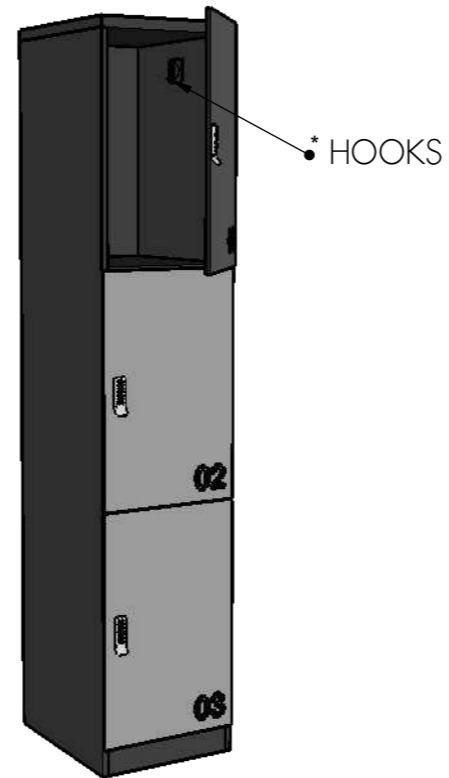

MODEL C  
\* ADDITIONAL HOOKS

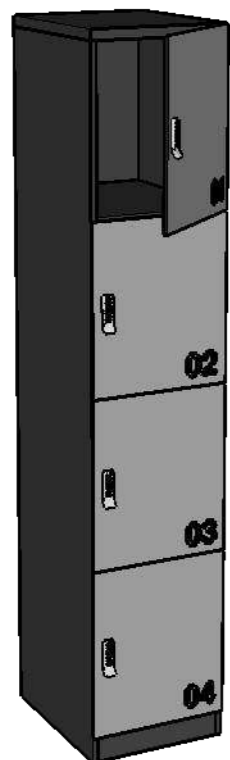

MODEL D

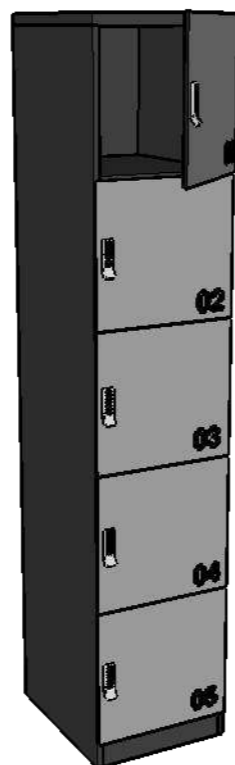

MODEL E

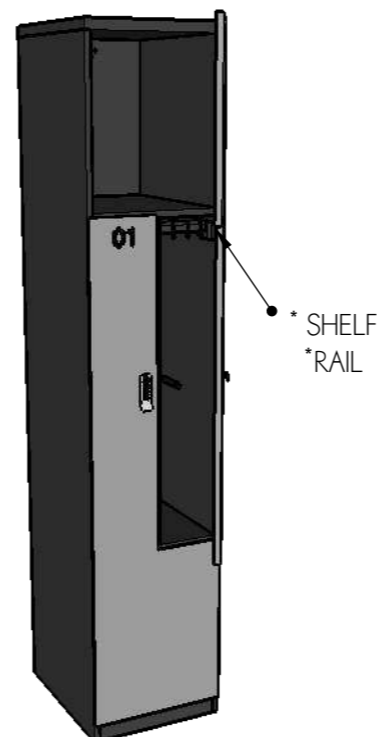

MODEL L  
\* ADDITIONAL SHELF  
\* RAIL WITH 3 HOOKS

METAL BODY 0.8 MM  
POWDER COATED ACCORDING TO PALETTE RAL

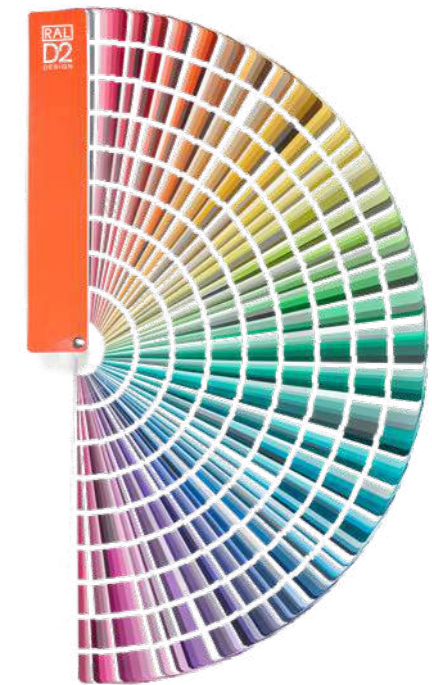

FRONT  
HPL BOARD 12 MM



MONOCOLORS



WOOD DECORS

## STANDARD DIMENSIONS

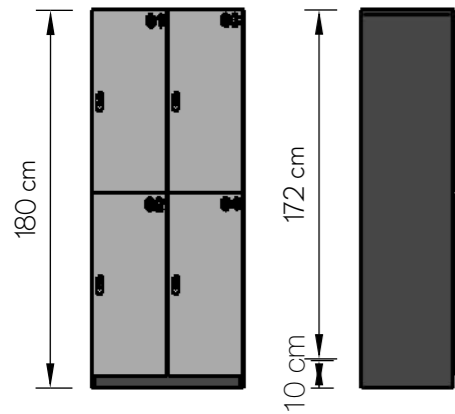

LOCKER ON A SOCLE

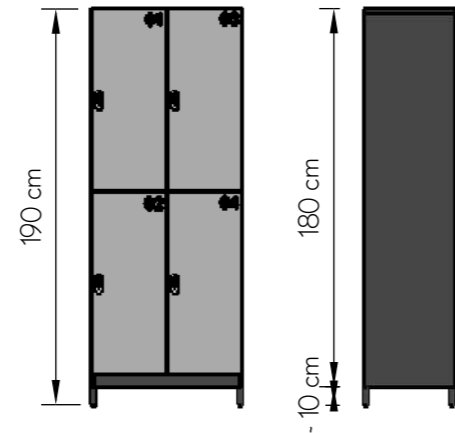

LOCKER ON ADJUSTABLE LEGS

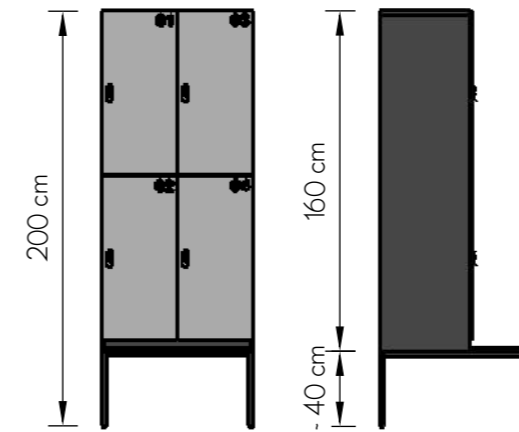

LOCKER ON A BENCH WITH HPL BOARD

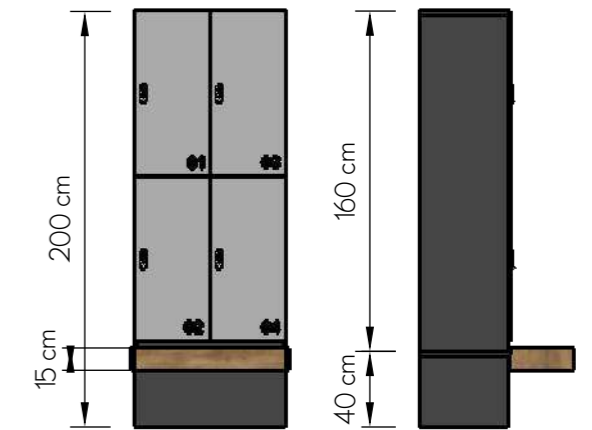

LOCKER ON A LPP BENCH WITH HPL BOARD

## CUSTOM DIMENSIONS

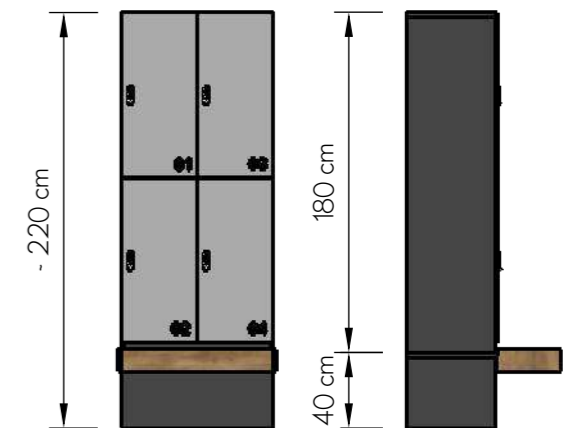
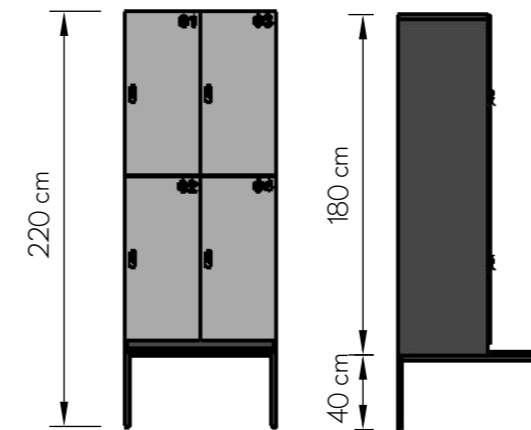
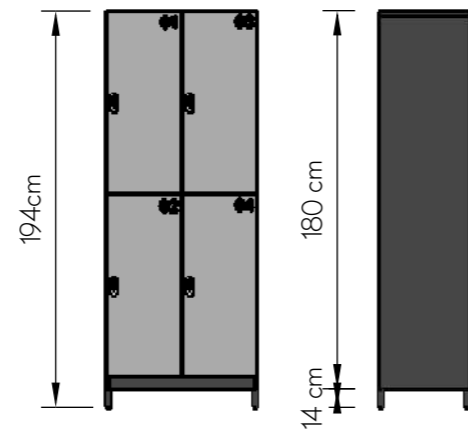
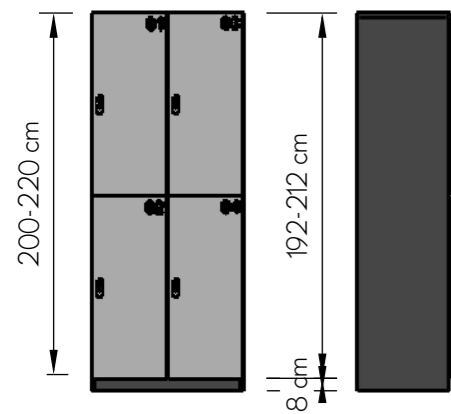

## METAL BODY



BODY IS MADE OF HIGH QUALITY METAL 0,8 MM THICK. LOCKER IS POWDER COATED ACCORDING TO PALETTE RAL. LOCKERS ARE MADE IN ACCORDANCE WITH EUROPEAN STANDARDS.

## FRONT AND BENCH MADE OF HPL BOARD

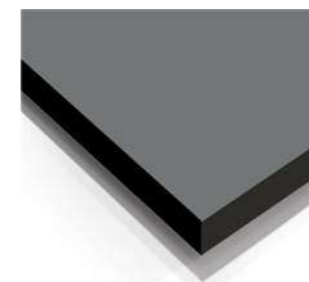

THIS IS A BOARD PRODUCED ACCORDING TO EN 438-4 TYPE CGS FOR DEMANDING APPLICATIONS. HPL HAS NOT PORES, IS EASY TO DISINFECTION, RESISTANT TO AGGRESSIVE, ACID CLEANING.

AMEZ ZEUS

LOKSEK





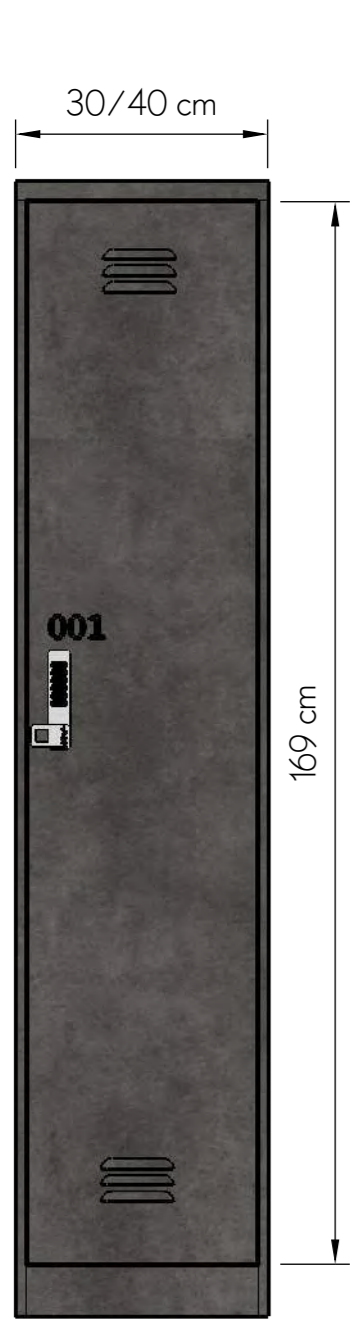

A1

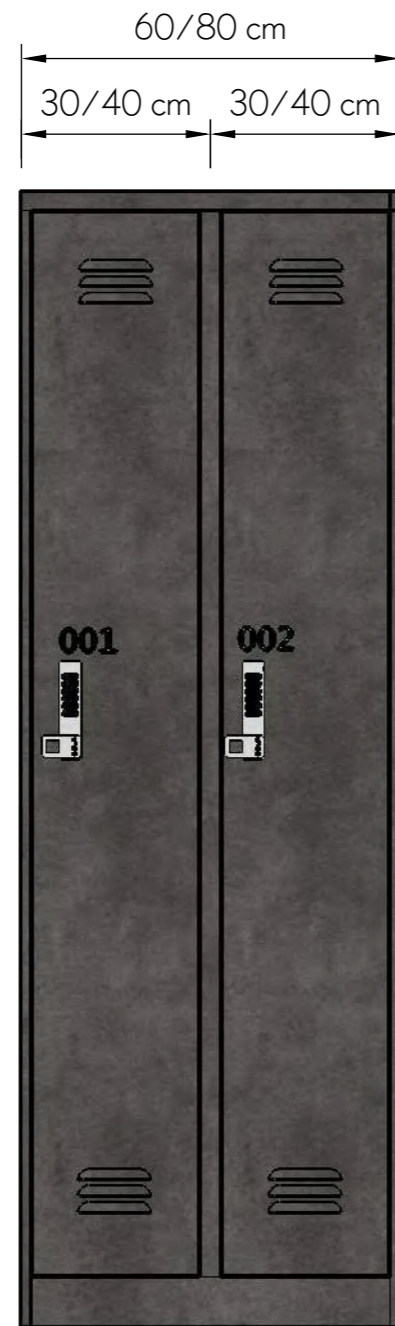

A2



A3

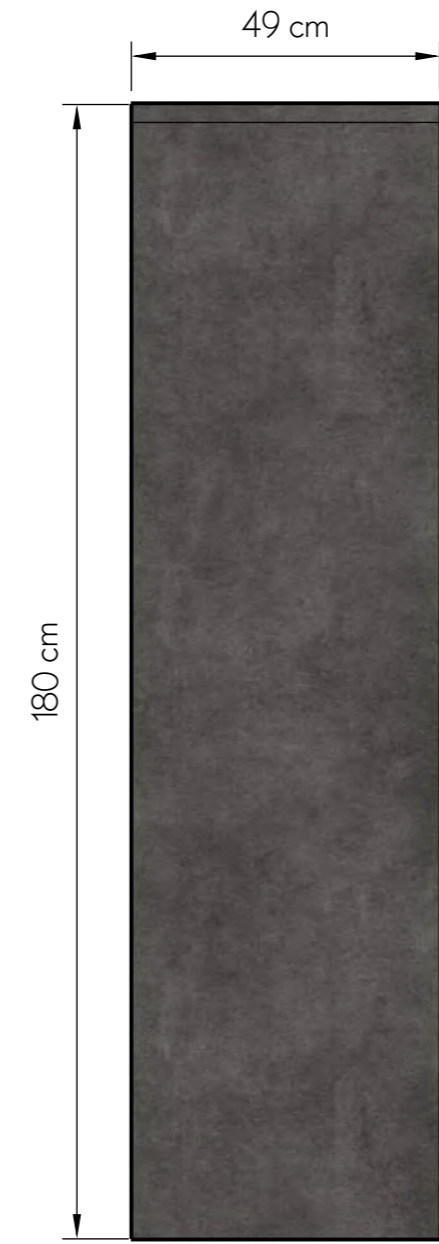

SIDE VIEW



BACK VIEW  
VENTILATION



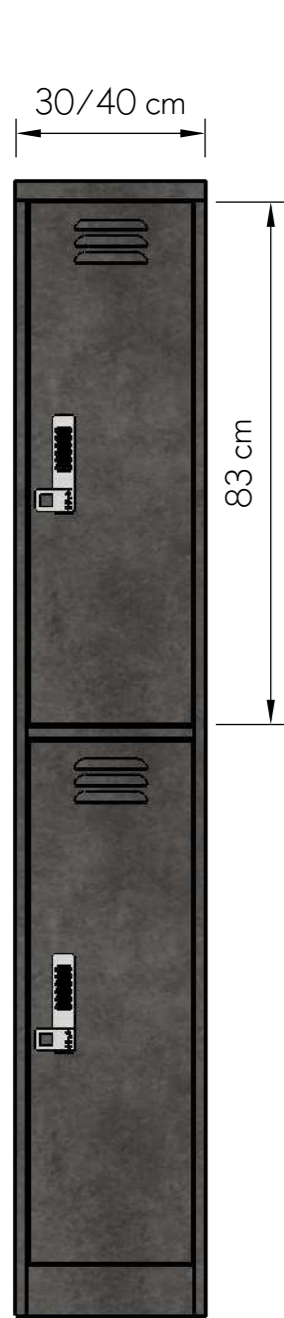

B2



B4

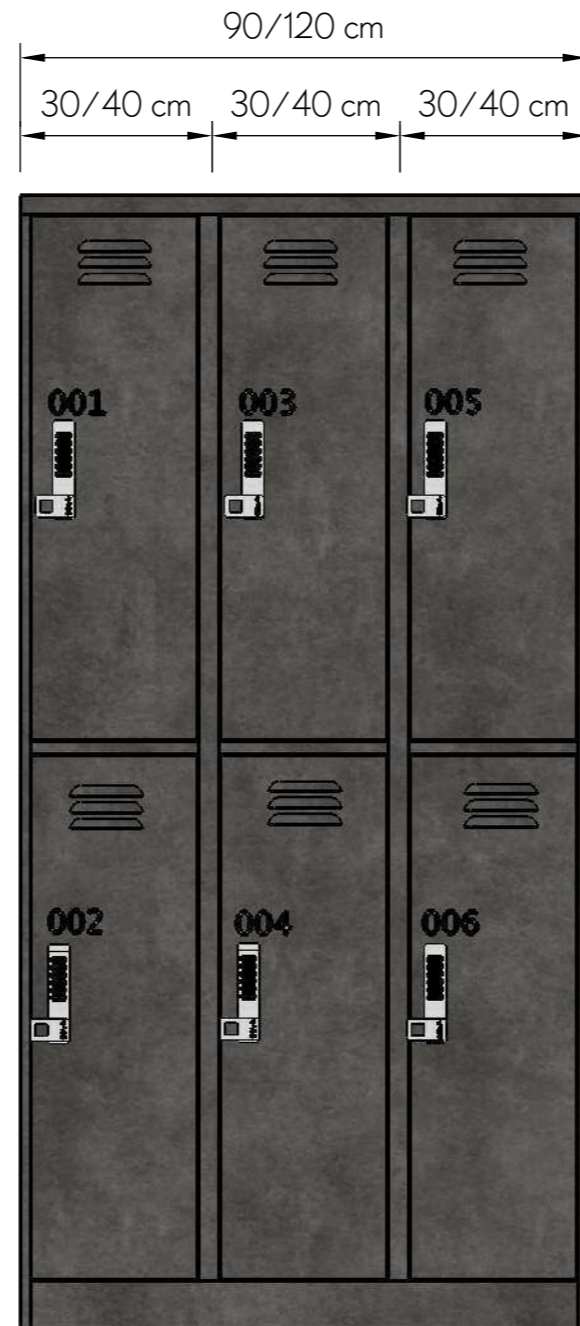

B6

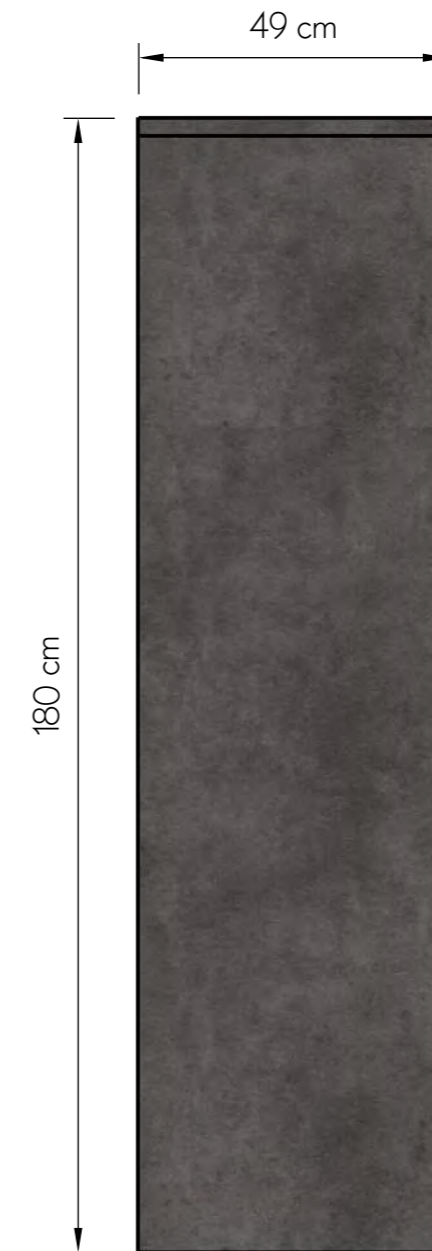

SIDE VIEW

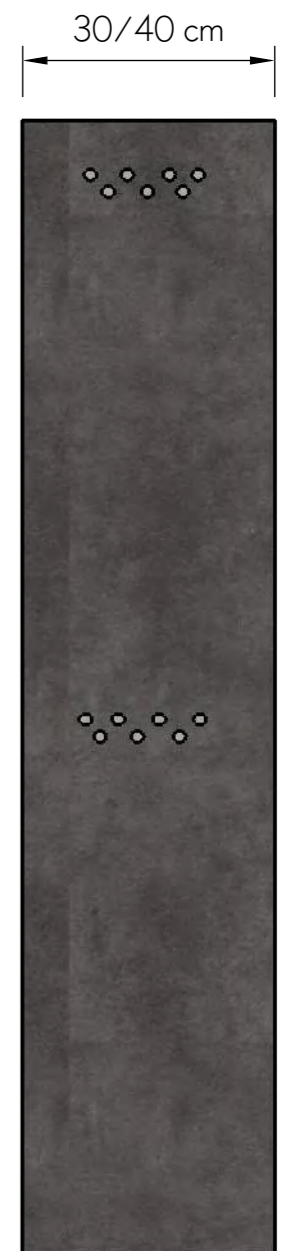

BACK VIEW  
VENTILATION

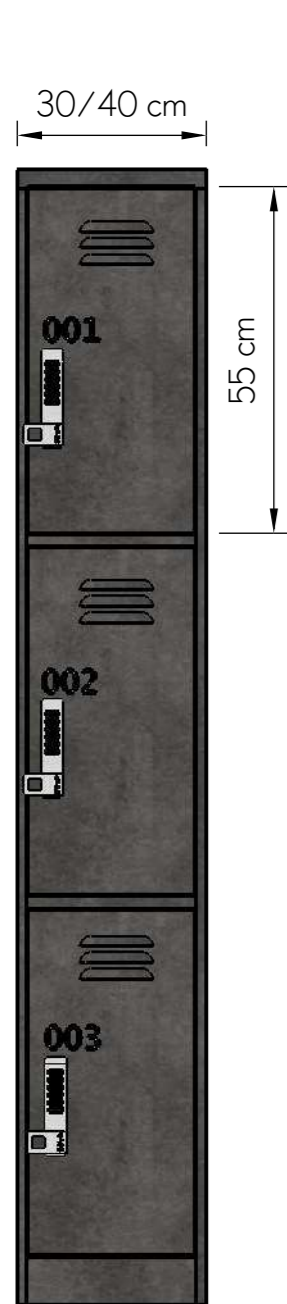

C3



C6

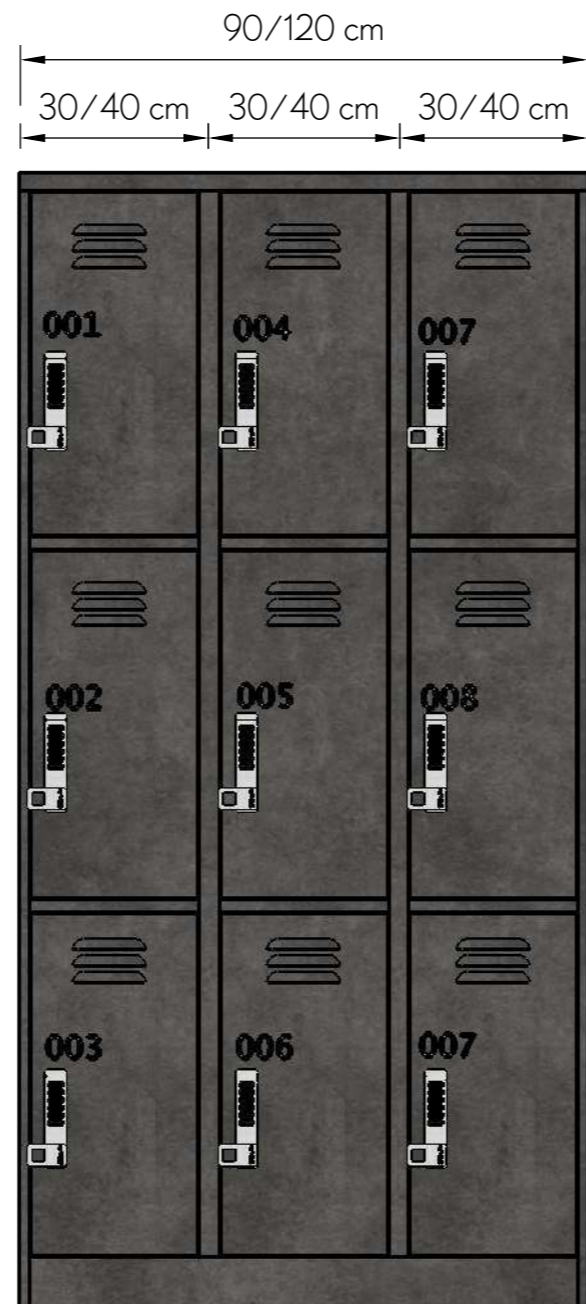

C9

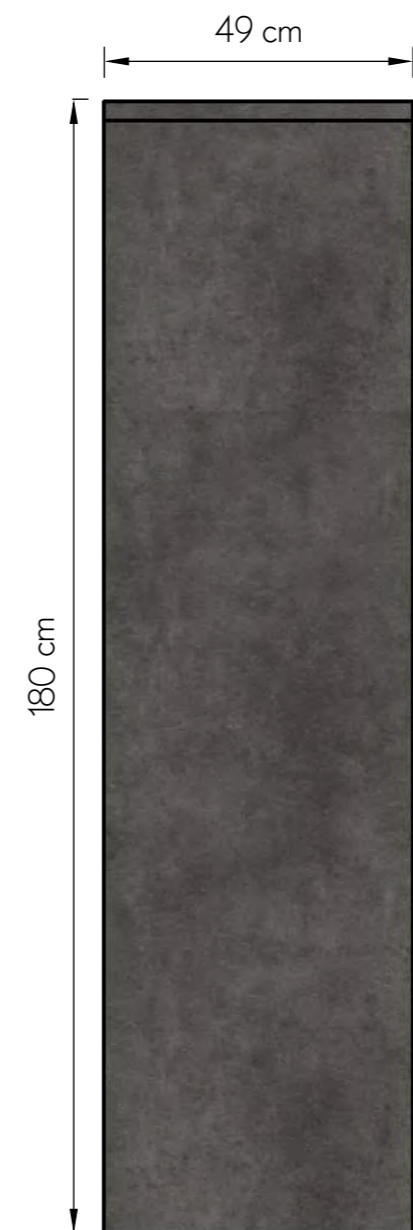

SIDE VIEW



BACK VIEW  
VENTILATION



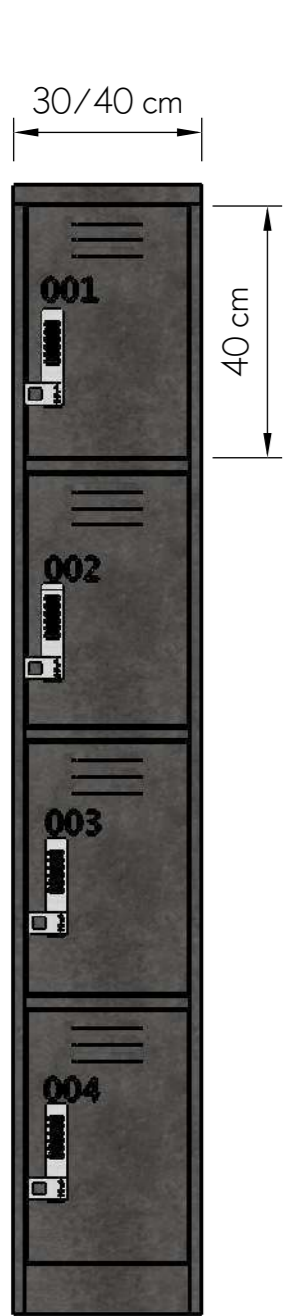

D4

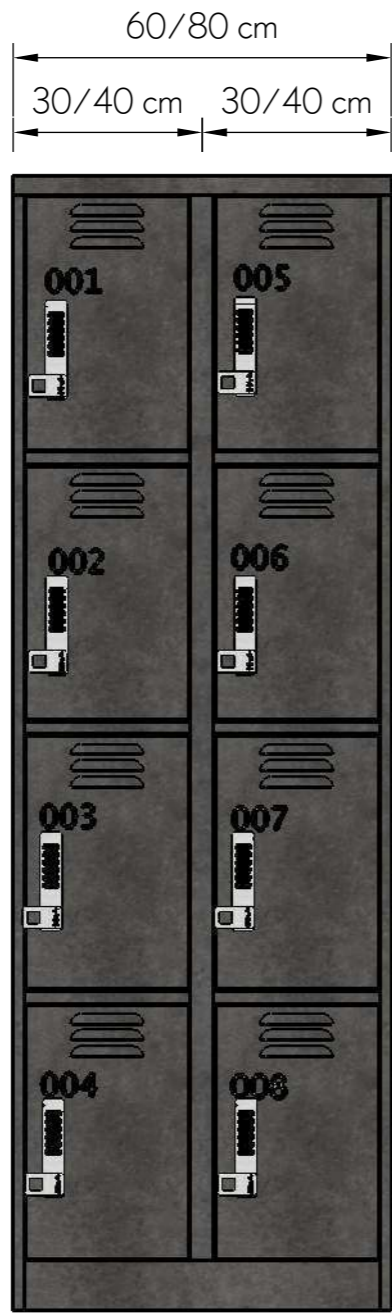

D8

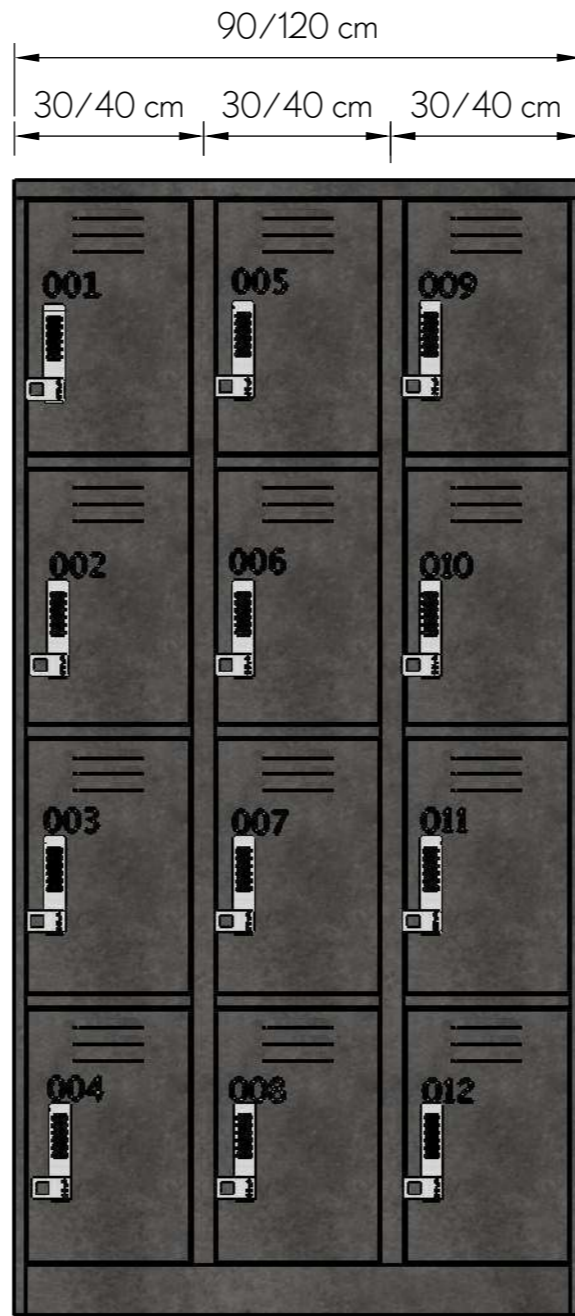

D12

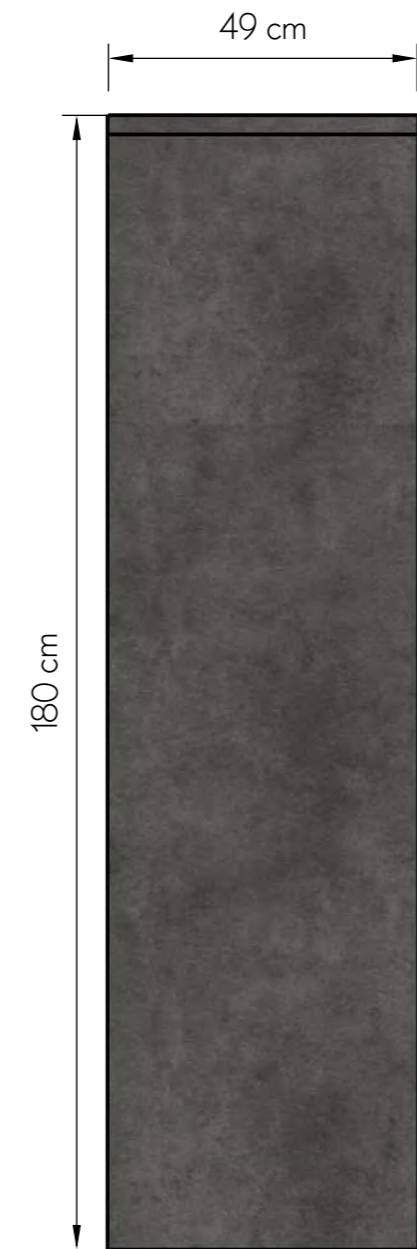

SIDE VIEW

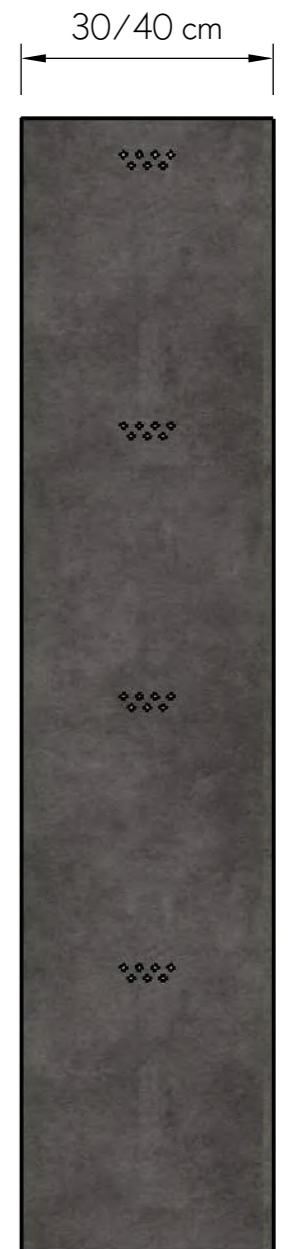

BACK VIEW  
VENTILATION

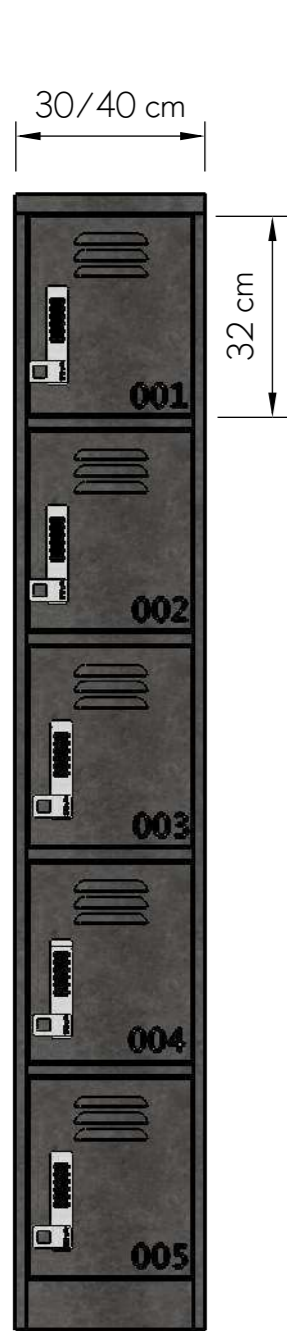

E5



E10



E15

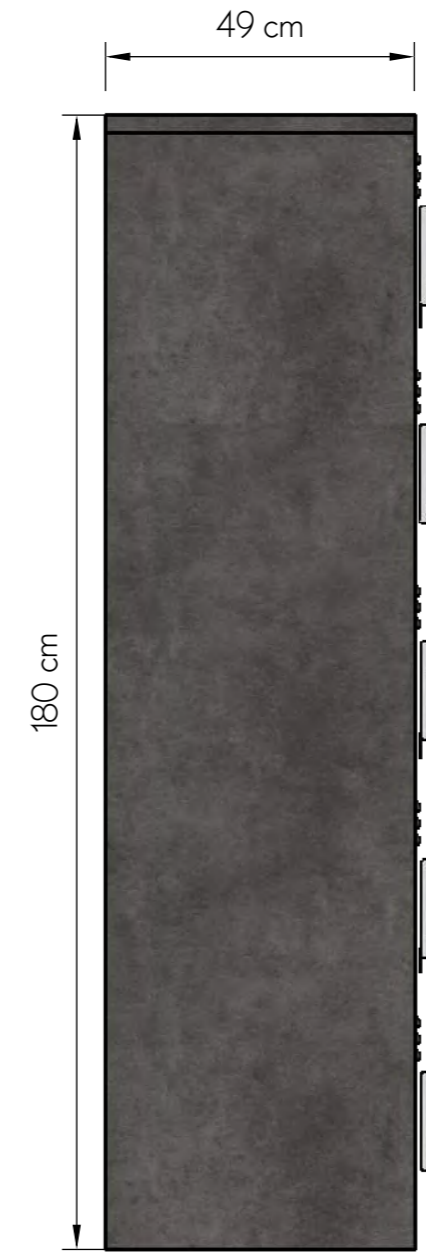

SIDE VIEW

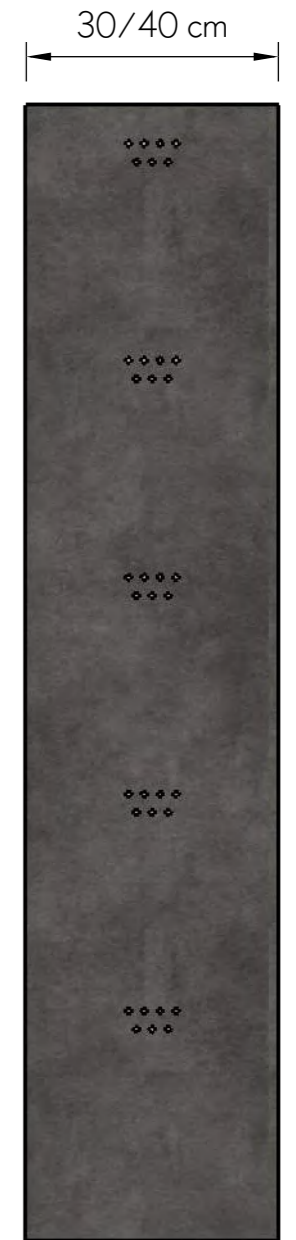

BACK VIEW  
VENTILATION



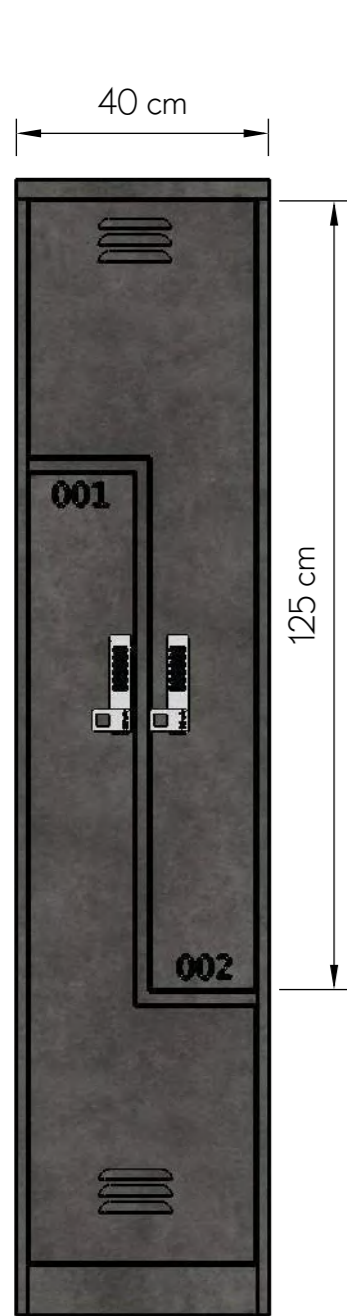

L2



L4



L6

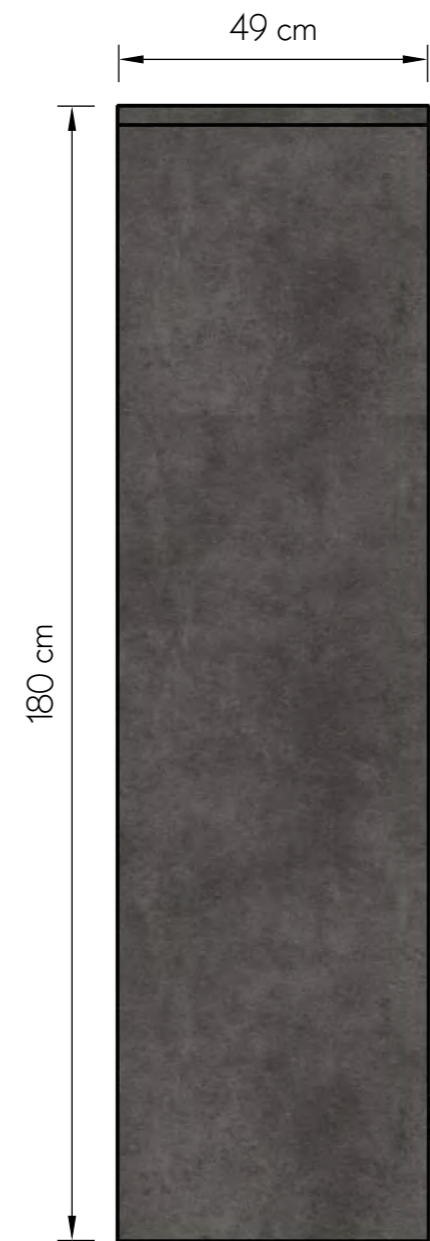

SIDE VIEW



BACK VIEW  
VENTILATION

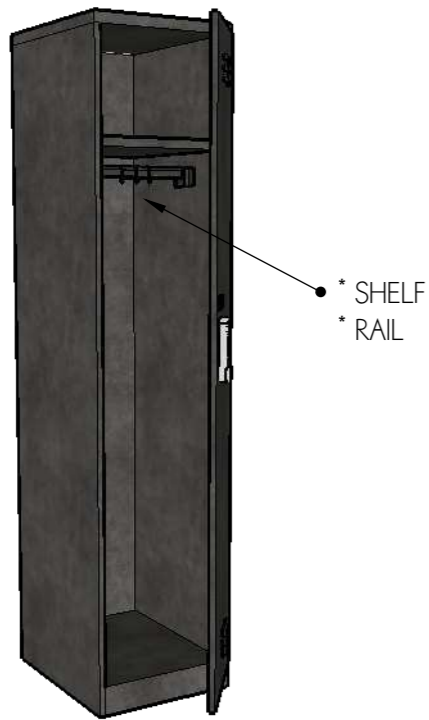

MODEL A  
\*ADDITIONAL SHELF  
\*RAIL WITH 3 HOOKS

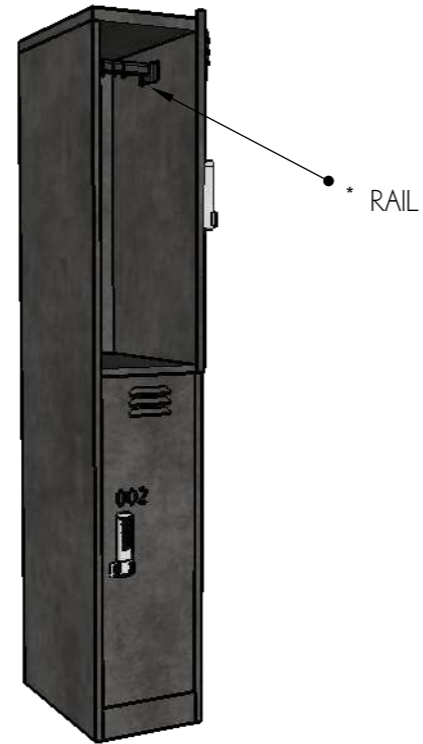

MODEL B  
\*RAIL WITH 3 HOOKS

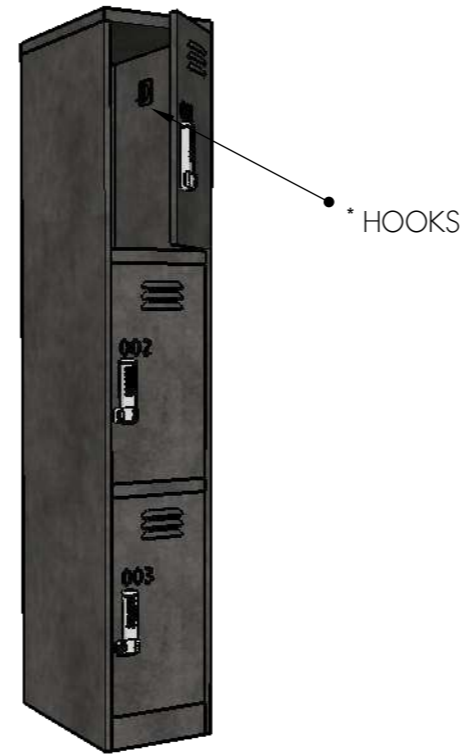

MODEL C  
\*ADDITIONAL HOOKS

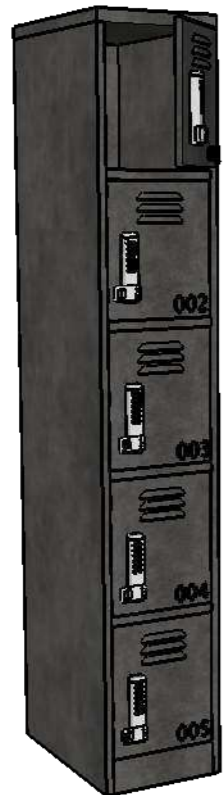

MODEL D

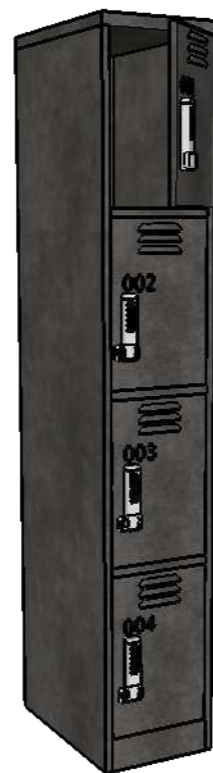

MODEL E

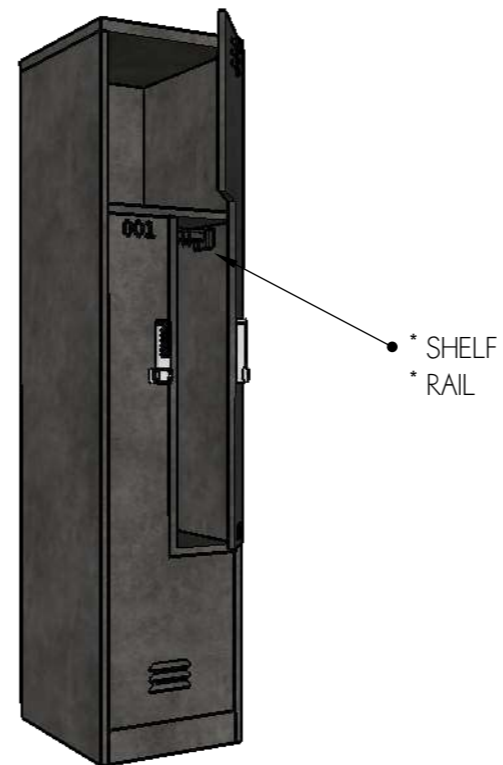

MODEL L  
\*ADDITIONAL SHELF  
\*RAIL WITH 3 HOOKS

METAL BODY AND FRONTS  
0,8 MM



BLACKENED STEEL

TYPES OF FRONT PERFORATIONS

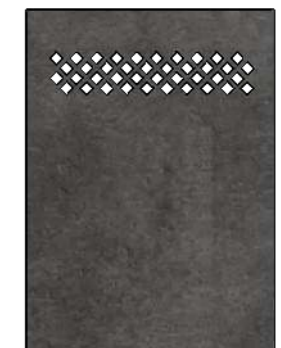



# LOKSEK

## STANDARD DIMENSIONS

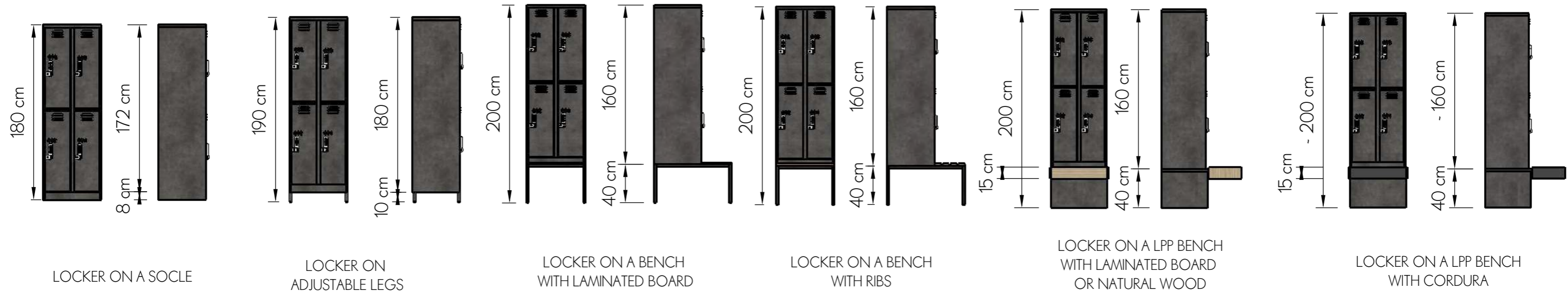

## CUSTOM DIMENSIONS

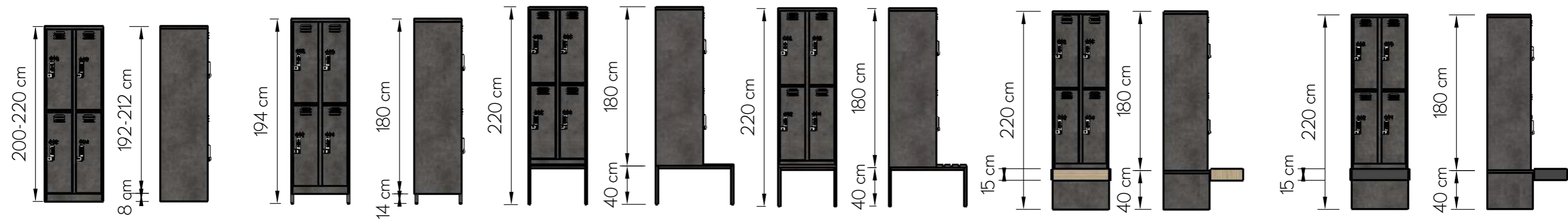

## METAL BODY

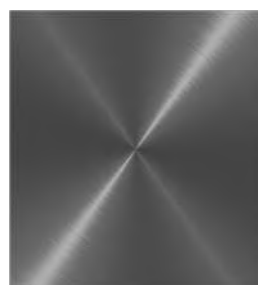

BODY IS MADE OF HIGH QUALITY METAL 0,8 MM THICK. LOCKER IS POWDER COATED ACCORDING TO PALETTE RAL. LOCKERS ARE MADE IN ACCORDANCE WITH EUROPEAN STANDARDS.

## BENCH FINISHING



CORDURA



LAMINATED BOARD



NATURAL WOOD



RIBS



A VOTRE SERVICE DEPUIS 1995

Amezeus  
Route de Taillepied 44, 1095 Lutry, Switzerland  
direction@amezeus.com / amezeus.com  
(+41) 21 903 57 67